

Replacing an outdoor wood furnace with an advanced cordwood gasification boiler

Design and installation considerations

*Webinar presented in support of
Renewable Heat NY*



NYSERDA
Sponsored



AIA approved course:
RHNYWEB12017
1.0 LU credits

presented by:
John Siegenthaler, P.E.
Appropriate Designs
Holland Patent, NY
www.hydronicpros.com



image courtesy of Econoburn

New York State Energy Research &
Development Authority (provider #I034)

**Replacing an outdoor wood furnace with an
advanced cordwood gasification boiler**

RHNYWEB12017

John Siegenthaler, P.E.

May 11, 2017



Replacing an outdoor wood furnace with an advanced cordwood gasification boiler

Design and installation considerations

Course Description: This webinar presents what installers need to know based on the requirements of the Renewable Heat NY program. Specific topics include: How wood gasification boiler operates, thermal storage requirements, boiler venting, evaluating existing buried piping, freeze protection.

Learning Objectives:

1. Explain the advantages of cordwood boilers in comparison to outdoor wood furnaces.
2. Evaluate pros and cons of outdoor versus indoor placement of the cordwood gasification boiler.
3. Be able to explain several options for protecting outdoor boilers from freezing.
4. Describe why thermal storage is essential for cordwood gasification boiler systems.

The full day training program: **Hydronics for High Efficiency Biomass Boilers** presents more in-depth discussion of many topics that are summarized in this webinar.



NYSERDA
Sponsored



Why should you replace an outdoor wood furnace with an advanced cordwood gasification boiler ?

PARTICULATE EMISSIONS:

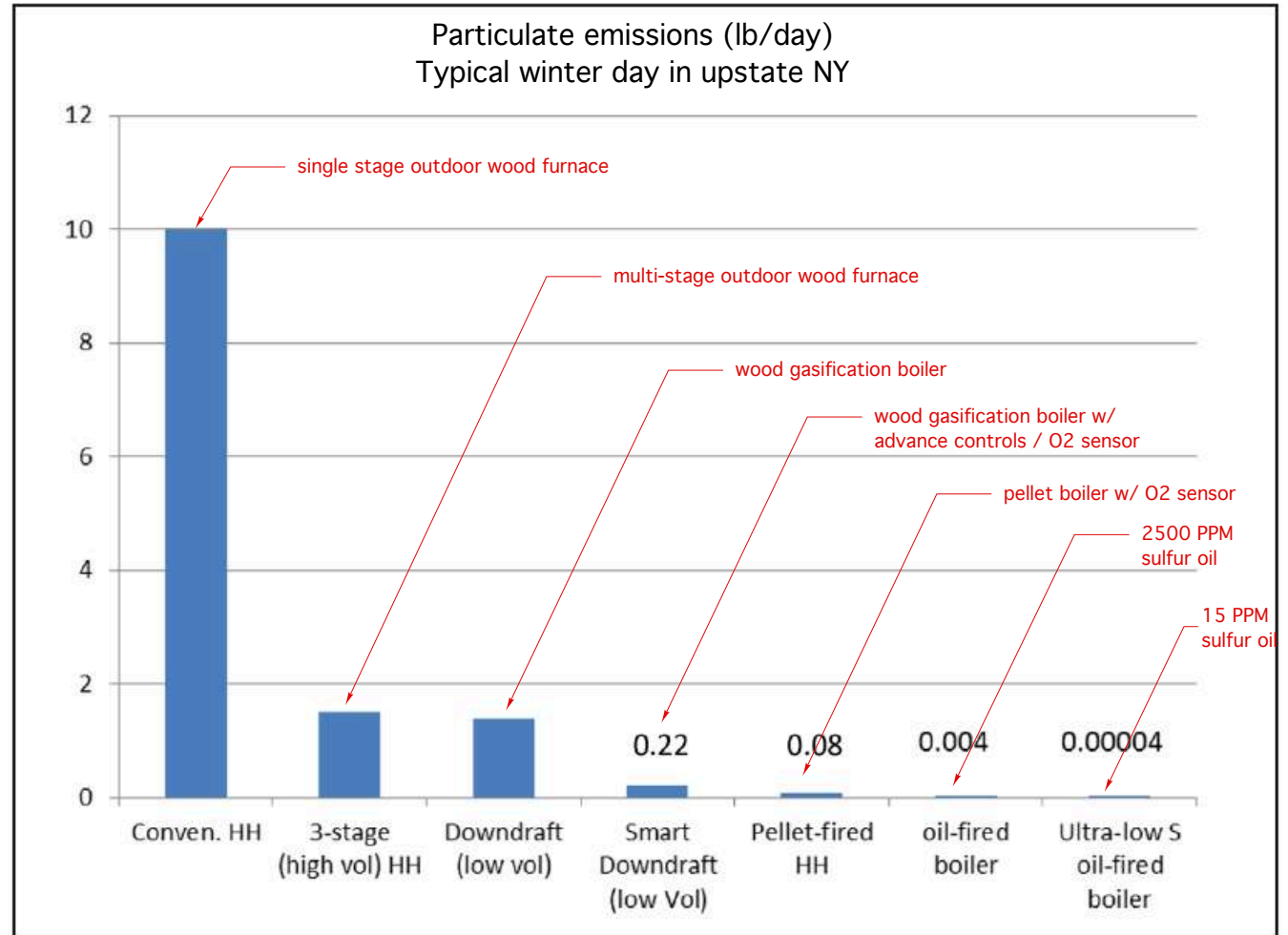

Figure 9. Comparative fine particulate matter (PM_{2.5}) emissions from several fuel-heating technology combinations for an average home in Central NY on a January day. NYSERDA report 12-15, 2012; Butcher, 2013; McDonald, 2009

One single stage outdoor wood furnace can emit as much PM 2.5 particulate emissions as 250,000 oil burners operating on low sulfur fuel oil!

Why should you replace an outdoor wood furnace with an advanced cordwood gasification boiler ?

THERMAL EFFICIENCIES

Typical thermal efficiencies based on 24 hour operation on cold day in upstate NY.

65%

A properly operated, advanced cordwood boiler extracts about 2-3 times more heat from dry (<20% m.c.) firewood compared to outdoor wood furnaces.



advanced cordwood gasification boiler

30%

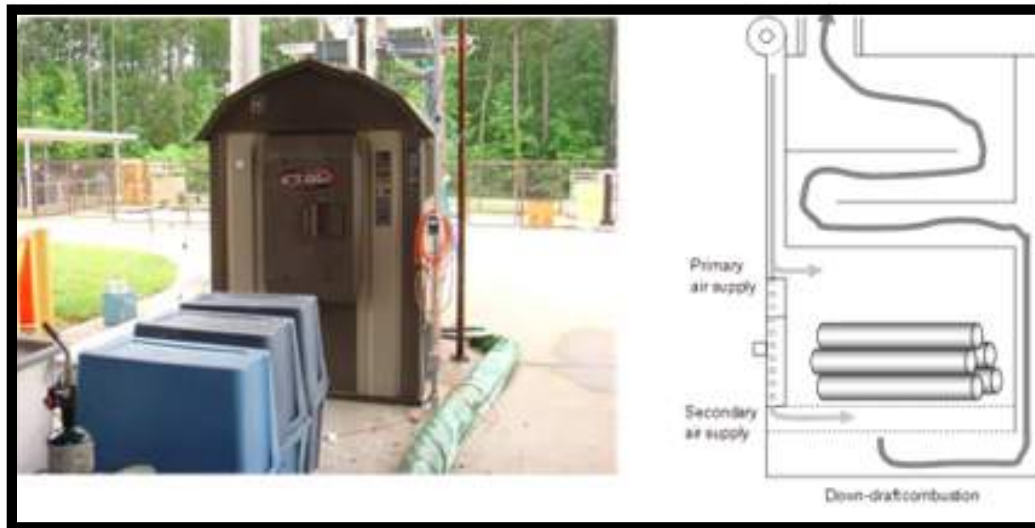

downdraft outdoor wood furnace w/ secondary & tertiary air control

22%



single stage outdoor wood furnace

Renewable Heat NY

google "Renewable Heat NY" for website

Program Manual

<https://www.nyserda.ny.gov/-/media/Files/FO/Current-Funding-Opportunities/PON-3010/3010attg.pdf>

Incentives and Financing

Total up to \$10,000, calculated as 25% installed cost up to \$5,000 per unit, with an additional \$5,000 for documented recycling (removal and destruction) of old outdoor or indoor wood boiler, or \$2,500 for recycling whole house wood furnace. Up to \$5,000 per installed unit is available for customers with existing oil heat or propane. Incentives are available on a first-come, first-served basis, and will only be reserved for customers once an application has been approved by NYSERDA.

Qualified Installers

<https://www.nyserda.ny.gov/-/media/Files/EERP/Renewables/Biomass/qualified-installers-boilers-pellets.pdf>

Qualified Cordwood Gasification Boilers

<https://www.nyserda.ny.gov/-/media/Files/EERP/Renewables/Biomass/Qualified-Cordwood-Boilers.pdf>

Boiler Model	Seasonal Efficiency (%) HHV	PM2.5 Emissions (lb/MMBtu)	Thermal storage tank minimum volume (gallons)		Link to Company Website
			Pressurized	Unpressurized	
Tarm-Froling FGH 20/ Froling S3 Turbo 30	69	0.18	525	600	http://woodboilers.com/
Econoburn EBW 200-170	60	0.16	600	700	http://www.econoburn.com/
Hydronic Specialty Supply Drummer - 35	60	0.32	400	420	http://www.hydrronicspecialtysupply.com/

Recently added: Varmbaronen Vedolux 30, 37, 55, 350, and 450 Advanced Cordwood Boiler Tarm/Froling S3 Turbo 50

NYSERDA contact for information on Renewable Heat NY program:

Matt McQuinn

17 Columbia Circle | Albany, NY 12203-6399

P: 518-862-1090 x3053 | F: 518-862-1091 | E: matt.mcquinn@nyserda.ny.gov

Wood gasification boilers

- 2-stage combustion
- effective thermal efficiency 60-70%
(80-85% @ high load, steady state)
- Very little ash or “clinker” residue

For best efficiency & lowest emissions :
Burn Hot & Burn fast (“batch burn”)

Heat output often exceeds heating load:
Storage is needed.

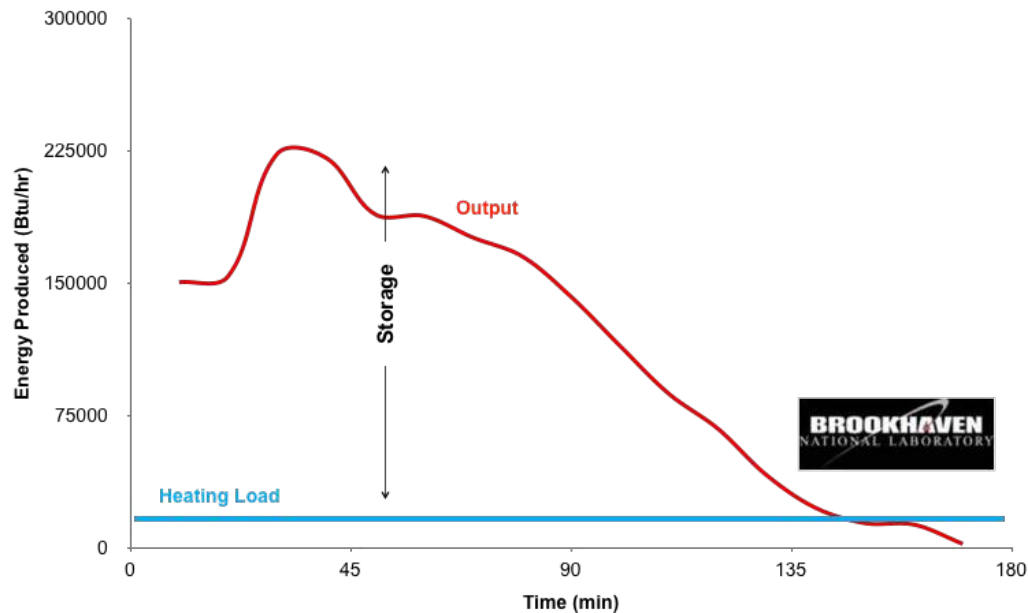

image courtesy of Econoburn



image courtesy of Smokeless Heat



image courtesy of Tarm Biomass

Wood gasification boilers

secondary combustion in lower chamber



courtesy of Econoburn

Firewood needs to be dry!

20% moisture maximum *INTERNAL* moisture content



Split open several pieces of firewood from the pile to check internal moisture %

end grain
moisture = 7.9%

split open internal
moisture = 16.0%



Key concepts:

Outdoor wood-burning furnaces are not boilers!

They are “open” “hydronic heaters” vented to atmosphere.

Open hydronic systems can have many challenges such as:

- corrosion of ferrous metals due to oxygen egress into system
- steam flash due to inability to pressurized system

Converting an existing system with an outdoor wood furnace to a wood gasification boiler requires the system to be converted from an “open” system to a “closed” system.

- Properly designed closed hydronic systems eliminate many of the corrosion and temperature / pressure limitations of open systems.

- All wood gasification boilers use carbon steel heat exchangers.

They cannot be directly connected to any “open” thermal storage tank.

- Recommend a complete flush of the existing system (minus the outdoor furnace) using a hydronic detergent



courtesy of Fernox



courtesy of Rhomar

There are currently no advanced cordwood gasification boilers with “exterior jackets” qualified under the RHHY program. This means that:

- A building will be needed to house an outdoor installation of a wood gasification boiler (and likely some cordwood).
- The wood gasification boiler and thermal storage will be installed in the building it will be heating.
- The wood gasification boiler and thermal storage can be installed in another building with underground insulated piping to another building.



Source: Econoburn



Source: Econoburn

Inside vs. outside placement or cordwood gasification boiler

From a *thermal standpoint*, the preferred location for a cordwood gasification boiler is within the building it is heating.

Reasons supporting INDOOR placement

- Boiler is protected from elements
 - Boiler is mostly protects from freezing
 - Heat losses from boiler are likely within thermal envelope of building.
 - Boiler can be fueled without going outside
 - No need for insulated underground piping or antifreeze
-

Reasons against INDOOR placement

- Increased potential for smoke in building
- Cordwood must be brought into building (dirt, bugs, moisture)
- Requires adequate space for service and safety
- Ashes must be removed from building
- Installation logistics: Boiler weighs several hundred pounds, and might not pass through some doors, down stairs, etc.

OUTDOOR location for cordwood gasification boiler

From a *thermal standpoint*, the preferred location for a cordwood gasification boiler is within the building it is heating.

Reasons supporting OUTDOOR placement

- Potential fire hazard is removed from building
 - Any smoke leakage is removed from building
 - Dirt, bugs, etc. that can be on cordwood kept remote from building
 - Doesn't require space in basement
 - Not restricted by door width, weight, stairs, etc.
-

Reasons against OUTDOOR placement

- Expense of constructing outdoor enclosure
- Need to protect boiler from freezing
- Expense of properly insulate underground piping / wiring
- Must go outside to fuel boiler
- Heat losses from boiler, and piping into building are outside thermal envelope of building

Combined wood storage / boiler bldg. (thermal storage in house)

Source: Richard Gibbs

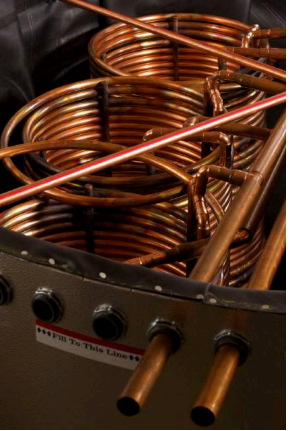

Concept for a simple combined boiler room / wood storage area.

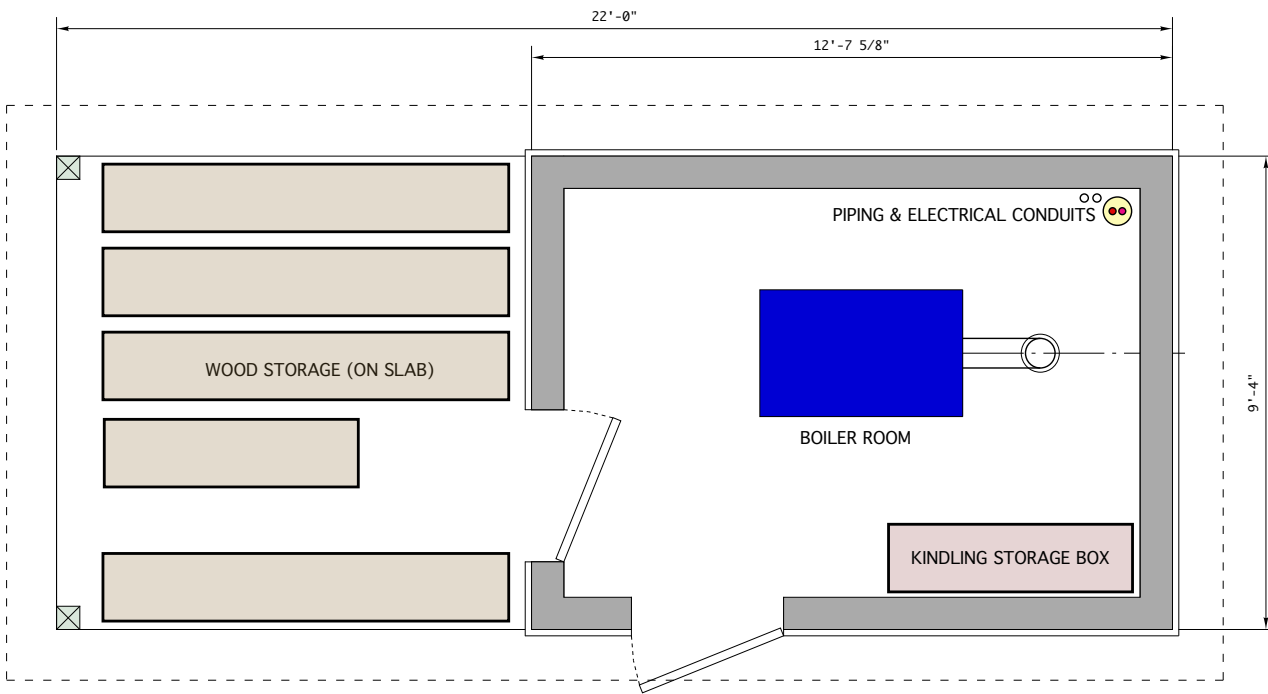
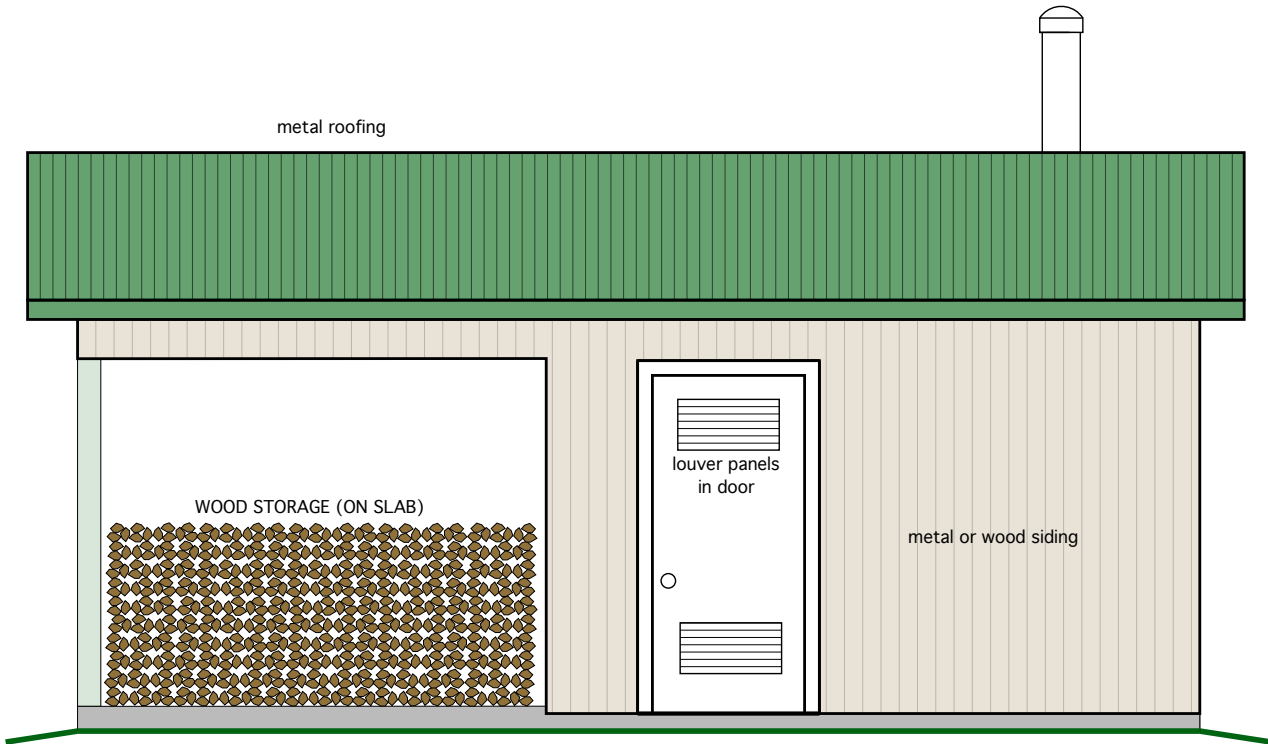
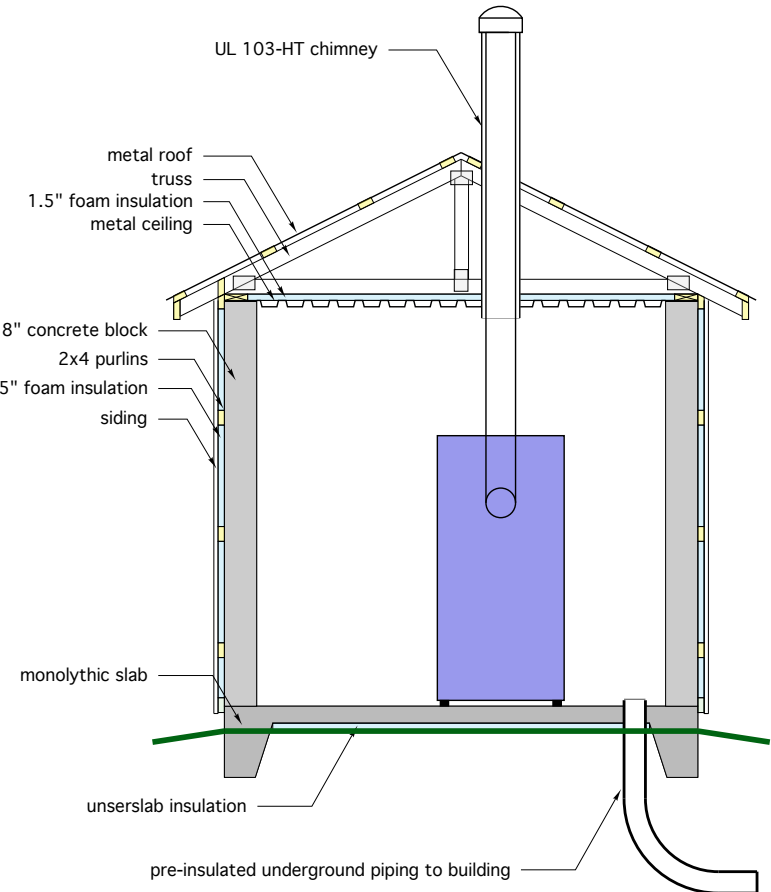

- 8" masonry block walls
- isolated / undercover wood storage
- 1.5" foam insulation of boiler room
- good access to boiler for cleaning

Concept for a combined boiler room / wood storage area, with thermal storage tank.

- 8" masonry block walls
- isolated / undercover wood storage
- 1.5" foam insulation of boiler room
- good access to boiler for cleaning
- wide doors for tank(s)

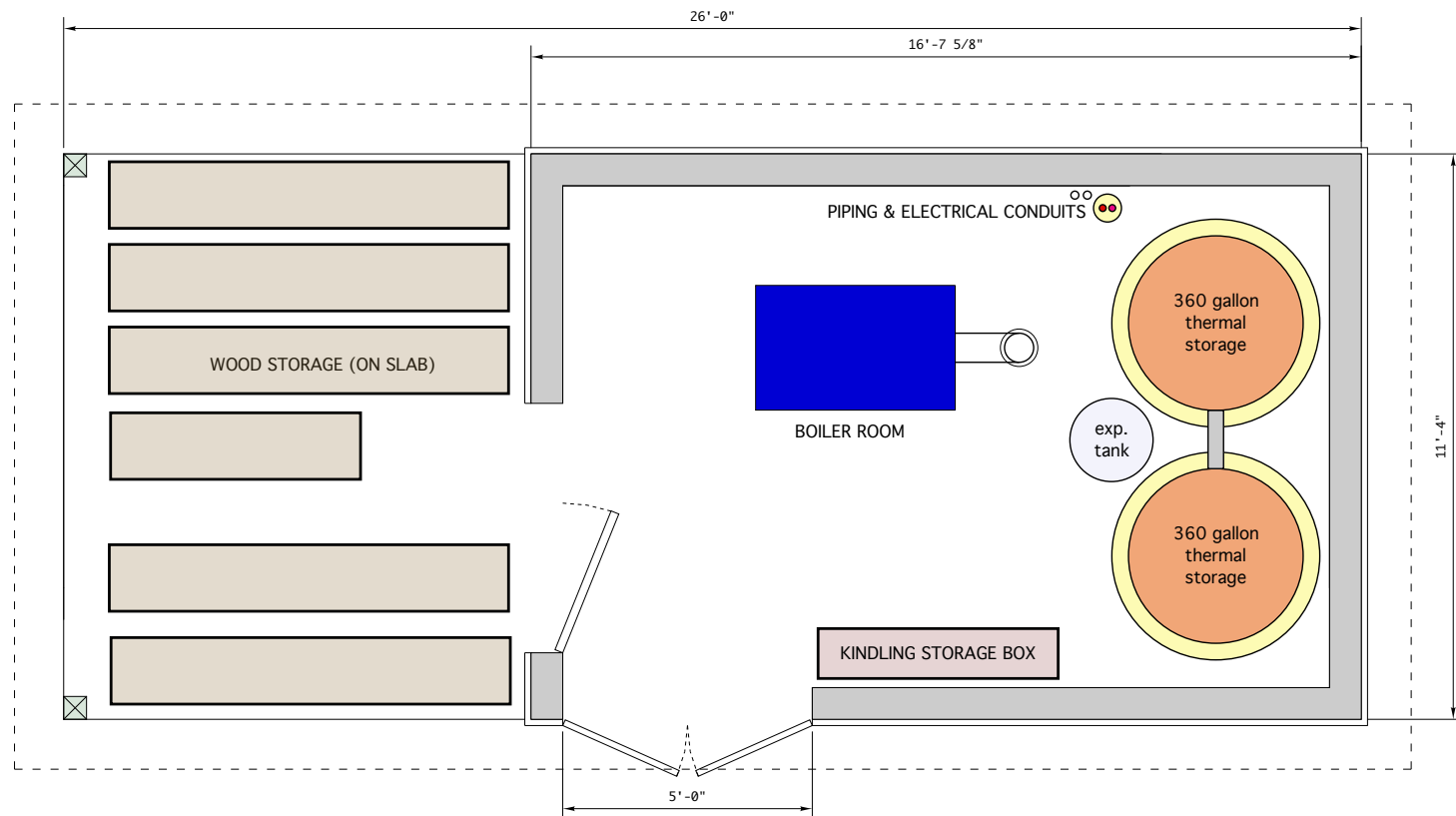
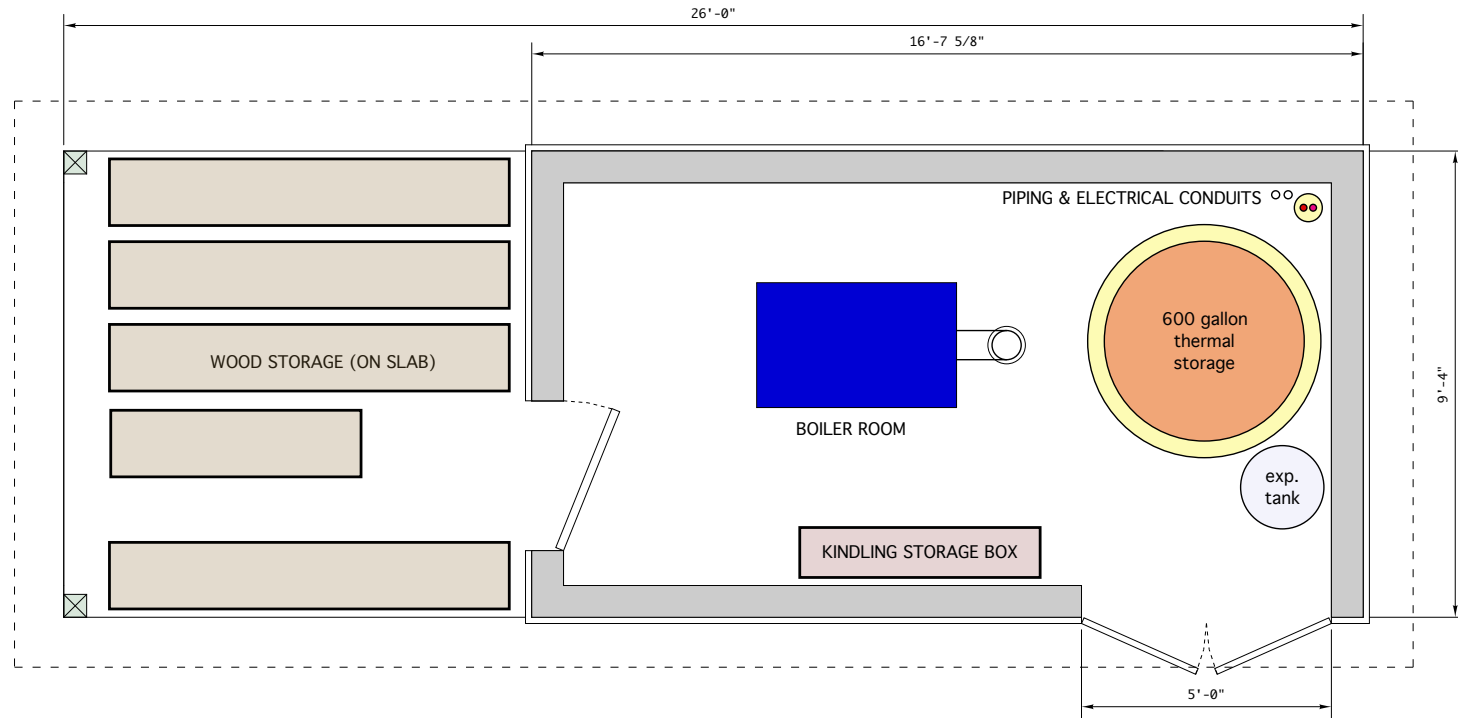

Example of "spacious" mechanical room layout

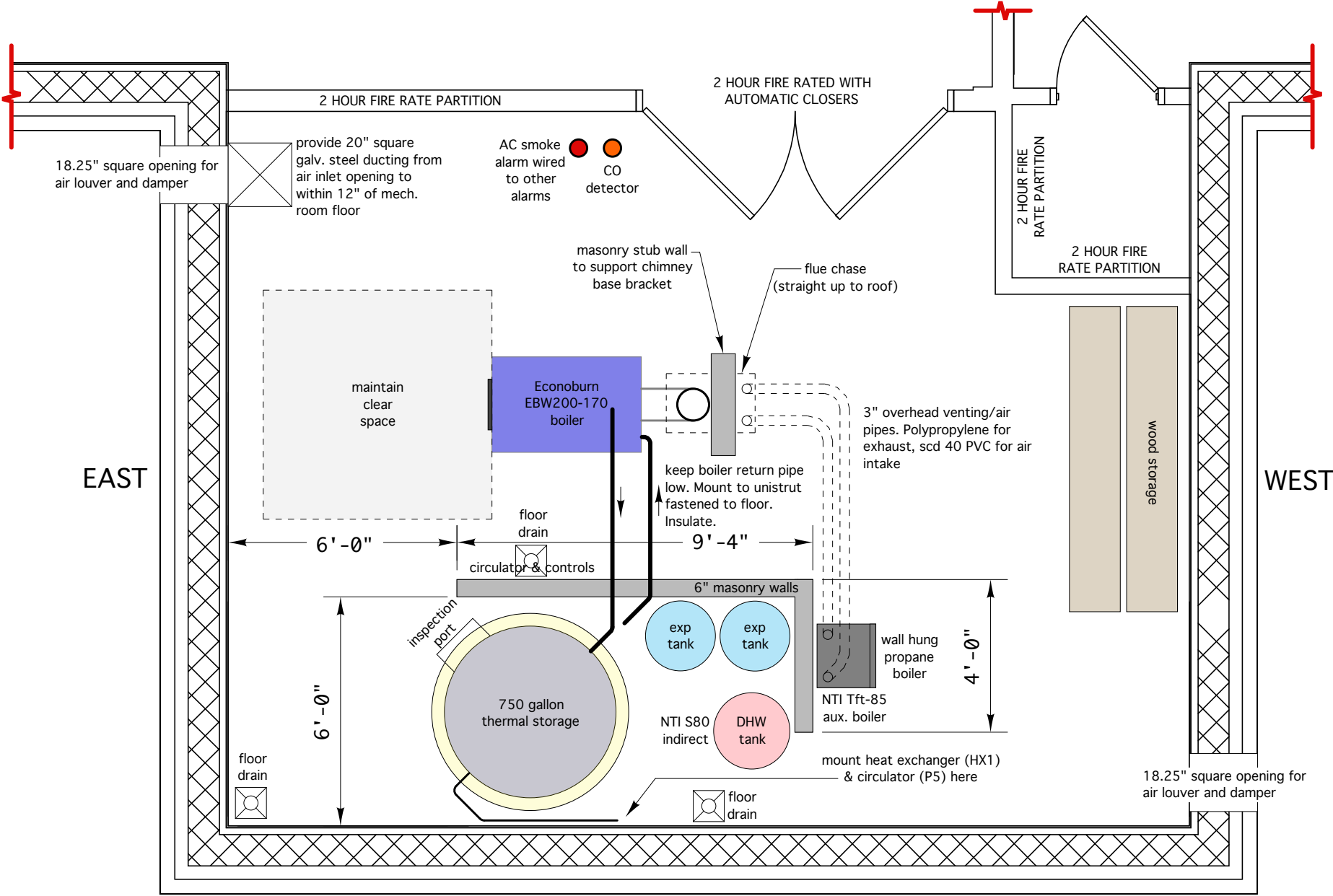

MECHANICAL ROOM LAYOUT

Boiler Venting

Most biomass boilers have draft inducing fans

Situation: Boiler starts up (draft fan on) but little if any draft established in cold chimney.

Exterior masonry chimney are the worst due to large / cold thermal mass.



Causes: Temporary POSITIVE pressure in vent connector piping.

Leads to: Leakage of flue gases and fly ash between joints in vent connector piping, boiler air intake, barometric damper.



Venting wood gasification boilers

Class A “all fuel” chimney (UL103-HT) 1000 °F continuous @1700 °F min. 10 minute. (stainless inner & outer wall, insulated) is typically recommended by most boiler manufacturers.

Interior chimney routing is preferred whenever possible.

Recommended resource for chimney sizing:



courtesy of Selkirk

Venting wood gasification boilers

UL-103 HT chimney straight up through interior space is ideal

Install positive pressure sealing draft regulator at least 1 foot below vent connector tee.

Some boilers can be configured for “pre-purge” exhaust blower operation.

Seal all joints in vent connector piping.

Mechanically secure all joints in vent connector piping with minimum of 3 sheet metal screws (stainless screws on single wall pipe).

- Seal joints with high temperature (1000 °F rated) black silicone sealant

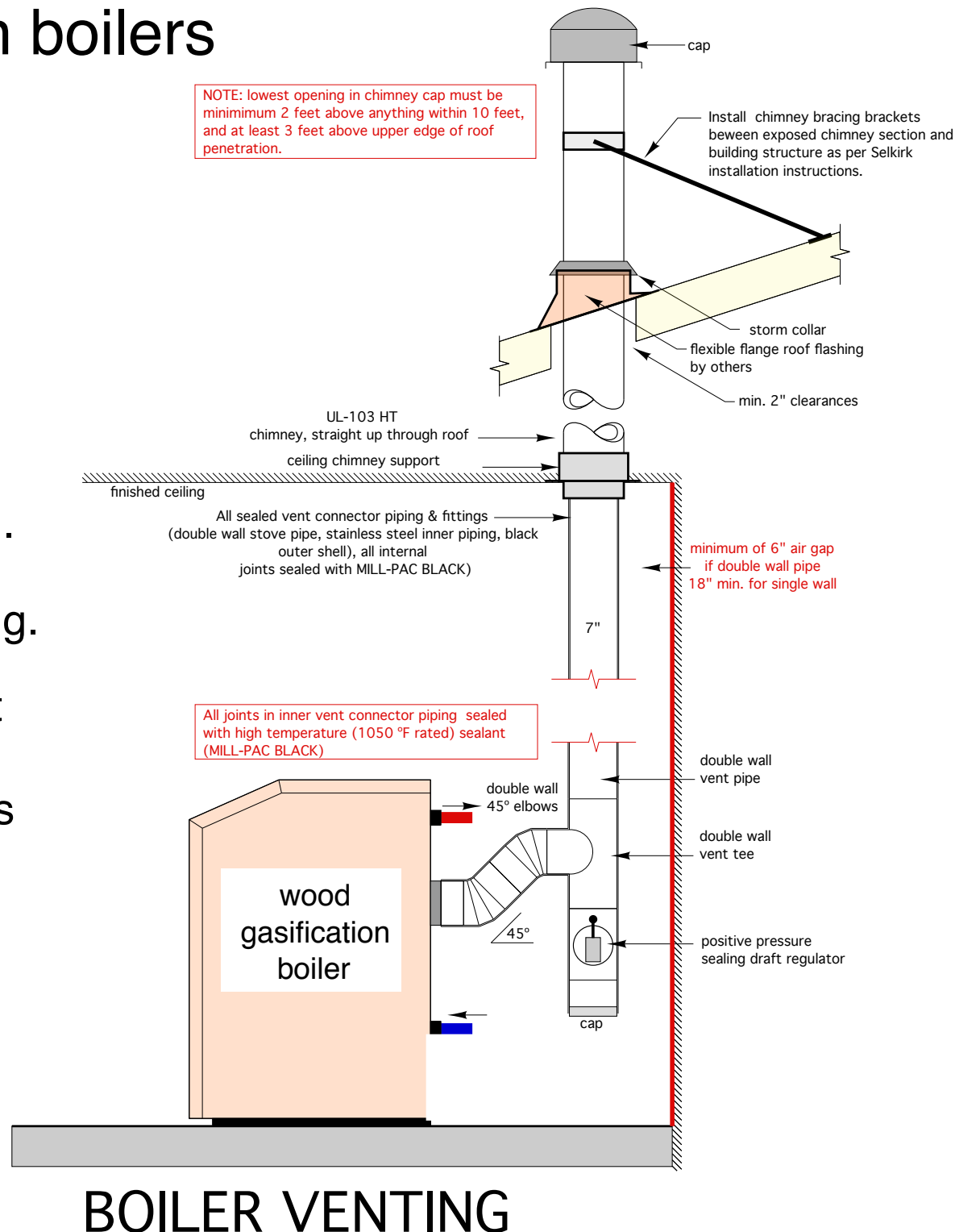

Double Wall vent connector piping allows 6" clearance to combustibles and lower surface temperature.

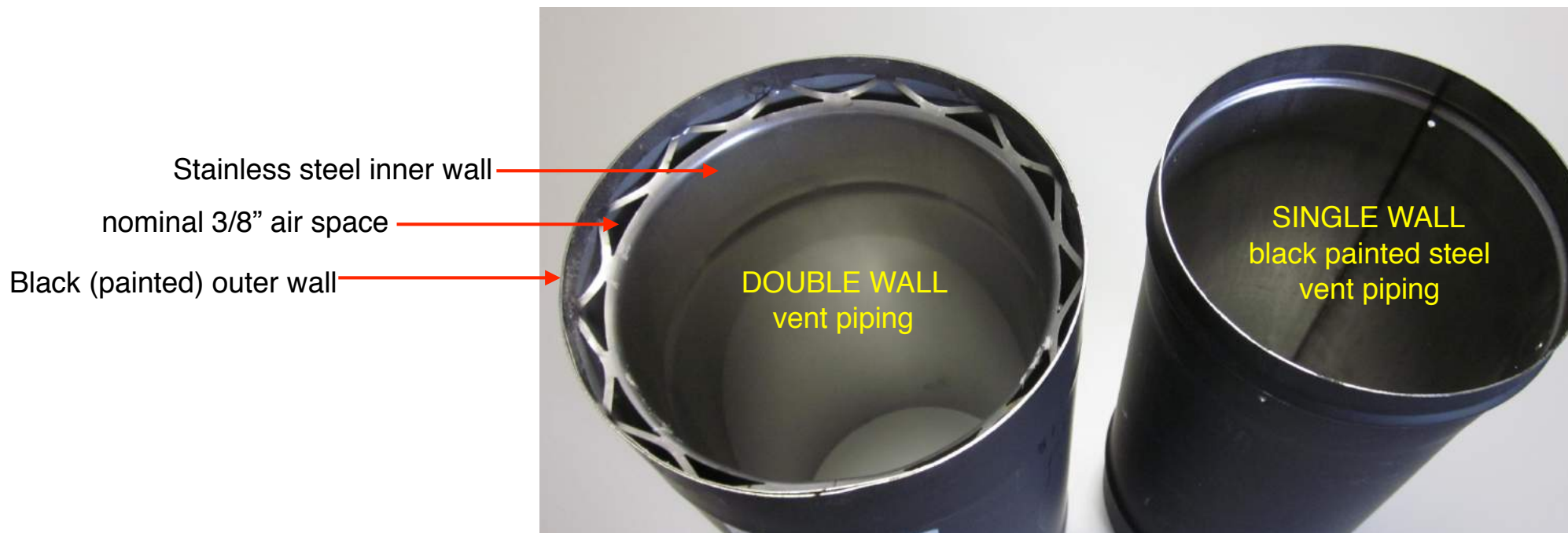

- Inner wall remains at higher temperature, resulting in less creosote potential.

- Outer wall remains at lower temperature, resulting in safer installation.

- Inner wall connections should be sealed with 1000 °F flexible sealant to prevent leaks.

- Outer wall connections should be mechanically joined with 3 screws (usually provided with pipe)



Boiler room combustion / ventilation air

Don't starve boiler for air!

Requirements vary:

Verify the following:

- 1. Any local code requirements**
- 2. Boiler Manufacturer's requirements**

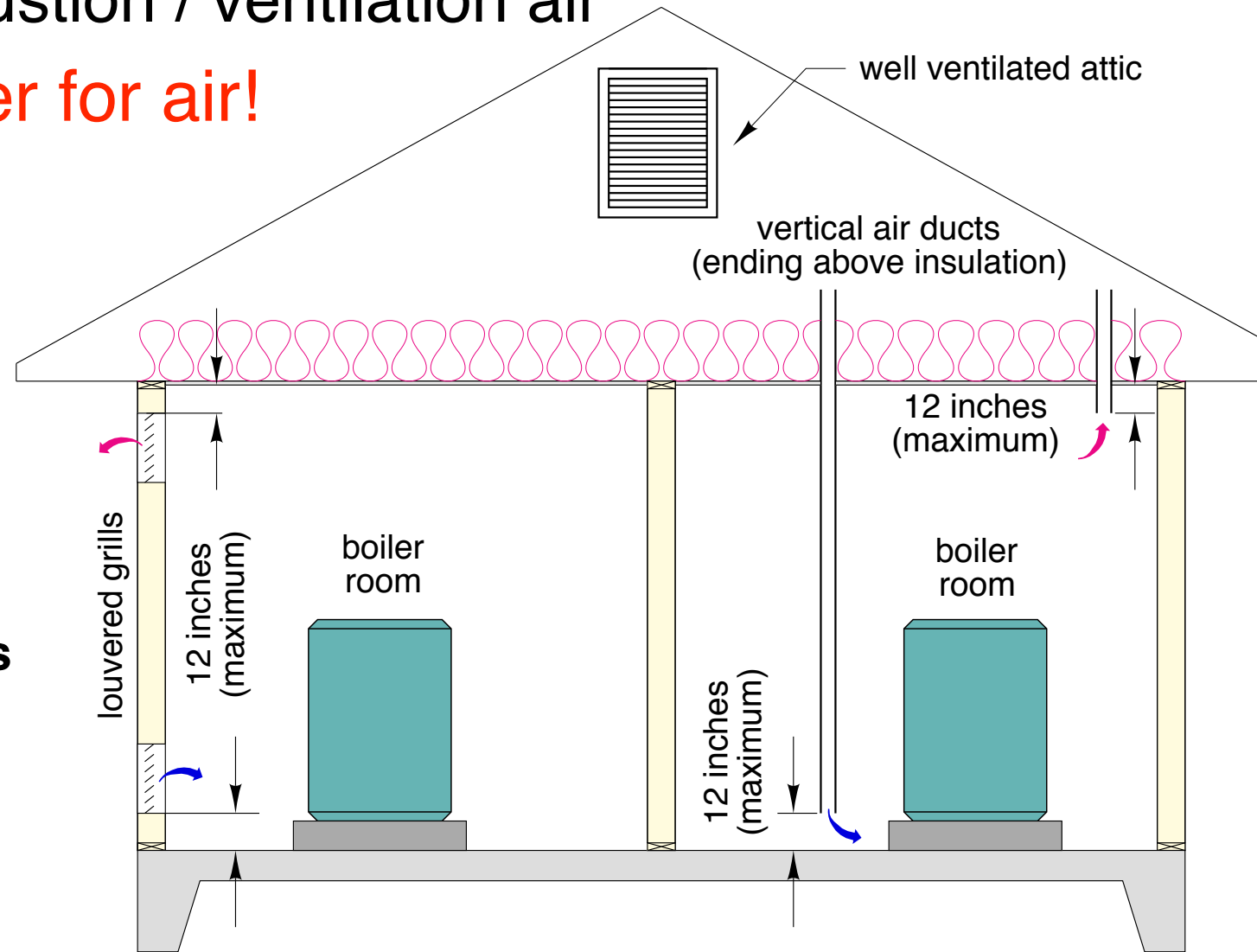

- Canadian ANSI/NFPA requirement is 1 in² of free area per 1000 Btu/hr of rated heat output. Reduce free area based on louvers.

- Typically two openings to outside, one starting within 12" below ceiling, other starting no more than 12" above floor

Thermal storage options

Water-based thermal storage options

1. unpressurized tanks

2. pressurized tanks

courtesy of American Solartech



courtesy of American Solartech



courtesy of Niles Steel Tank



courtesy of Hydroflex

Open (unpressurized) buffer tanks

Considerations:

- Water will evaporate - water level must be monitored
- Air space above water accommodates water expansion
- Many open tanks are “knock down” construction and are assembled on site
- Typically lower cost (\$/gallon) than pressurized tanks
- Requires one or more heat exchangers to interface with boiler or distribution system
- May require water treatment to control biological slime growth (use Fernox)
- Must use stainless steel or bronze circulators to handle open system water



courtesy of American Solartechics



courtesy of Hydroflex



courtesy of Cacoon Tanks

- Flow direction should produce counterflow heat exchange
- Use check valves to prevent thermosiphoning

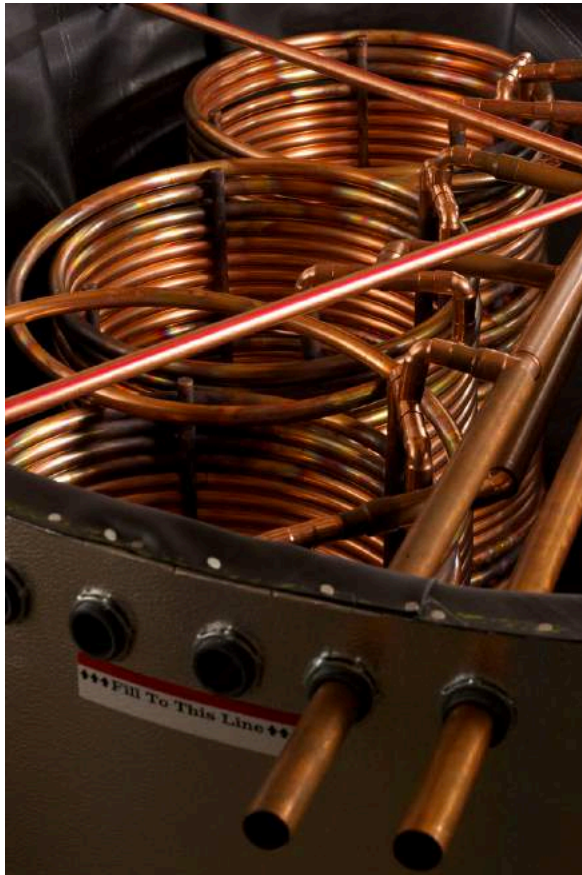

courtesy of Hydroflex

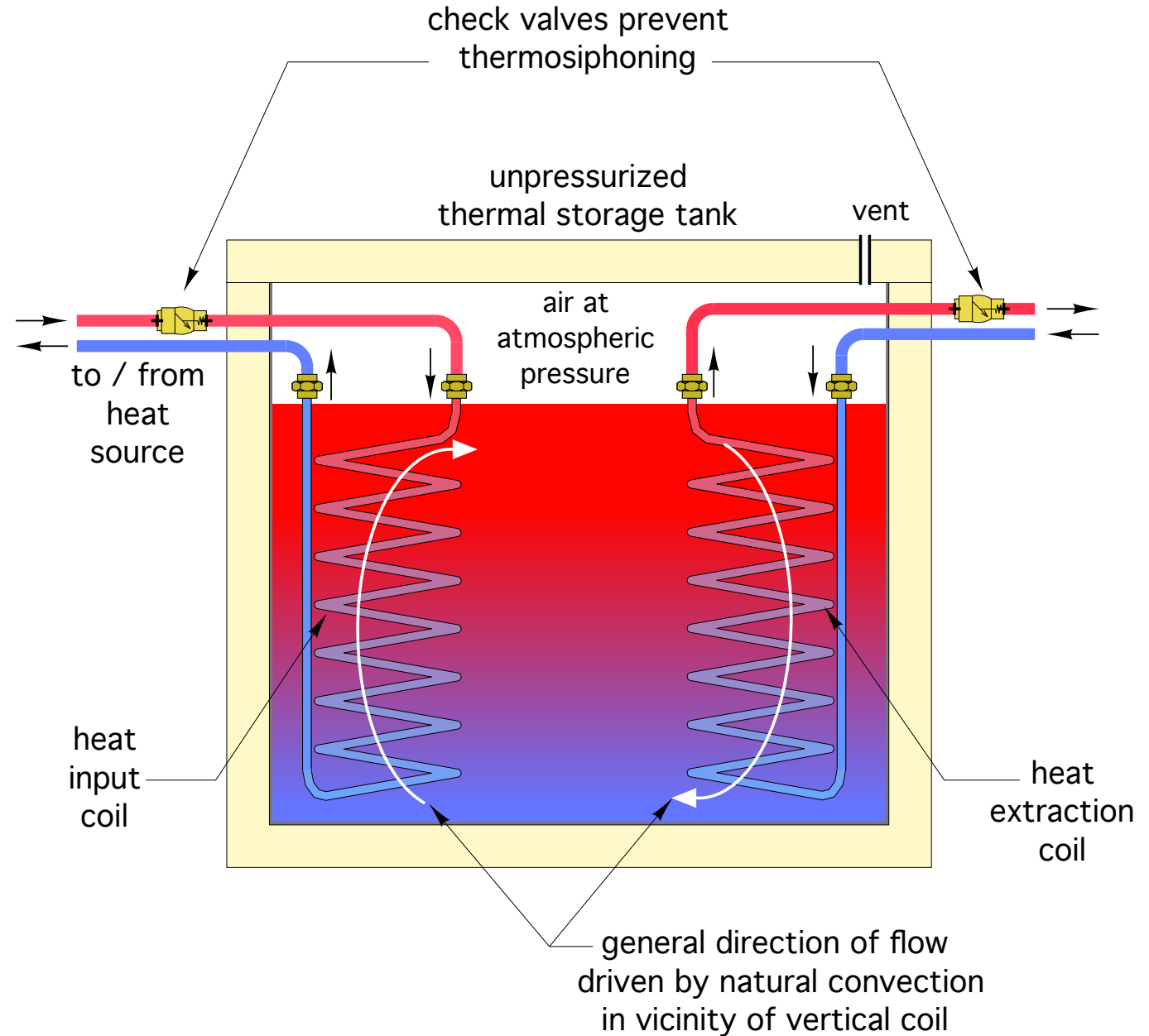

Closed/pressurized thermal storage tanks



courtesy of Caleffi North America



courtesy of Hydronic Specialty Supply



courtesy of Taco

Boiler Freeze Protection

Assuming boiler is
housed outside of
heated building



Freeze protection options for boiler in outdoor (unheated building)

OPTION 1: Use antifreeze in entire system

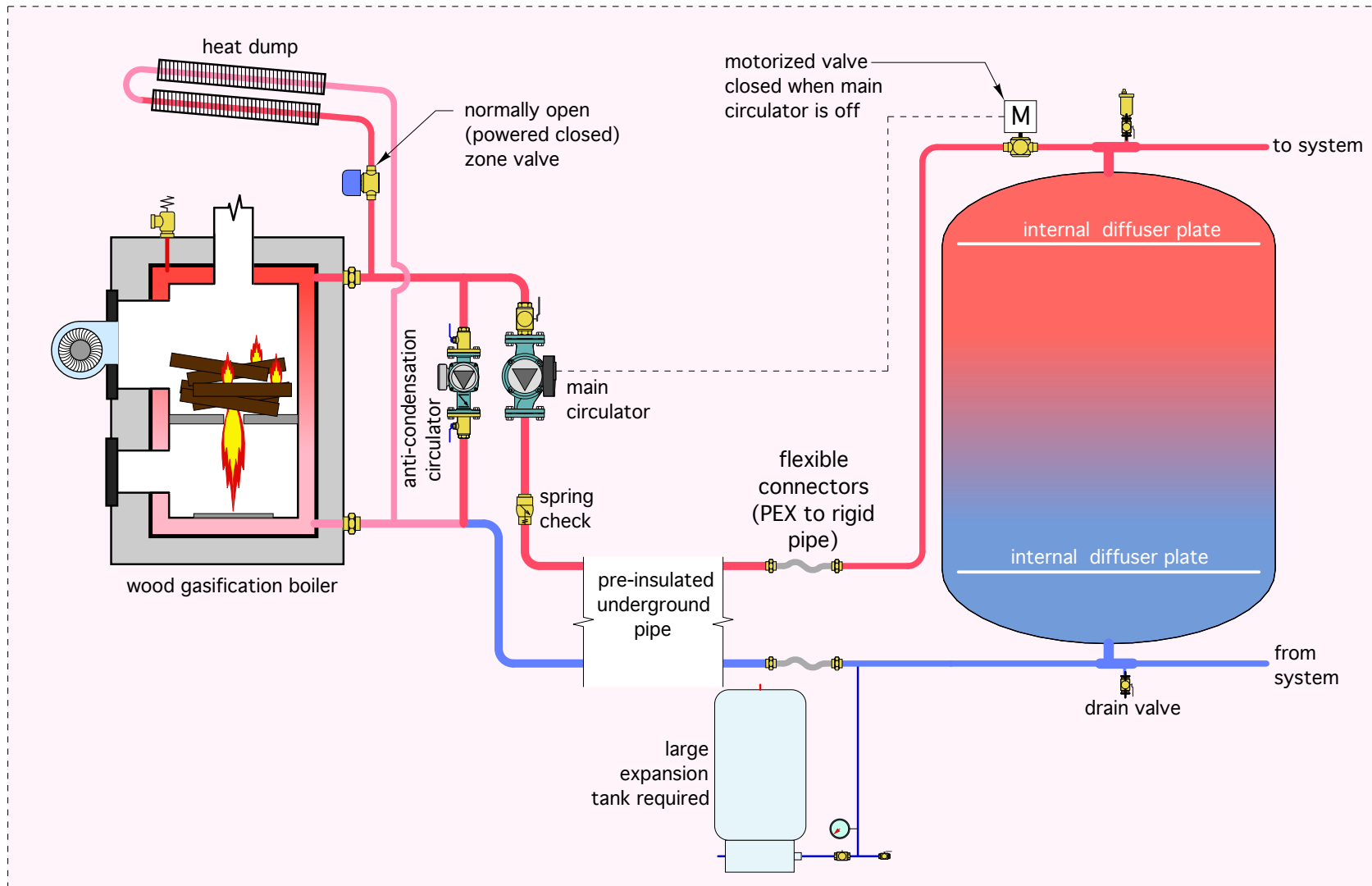

- ensured freeze protection all circumstances
- can add significant cost if high volume system
- antifreeze requires annual maintenance (pH testing)

- antifreeze reduces thermal storage ability of fluid (50% glycol stores about 90% of heat compared to all water)

Freeze protection options for boiler in outdoor (unheated building)

OPTION 2: Use water in entire system

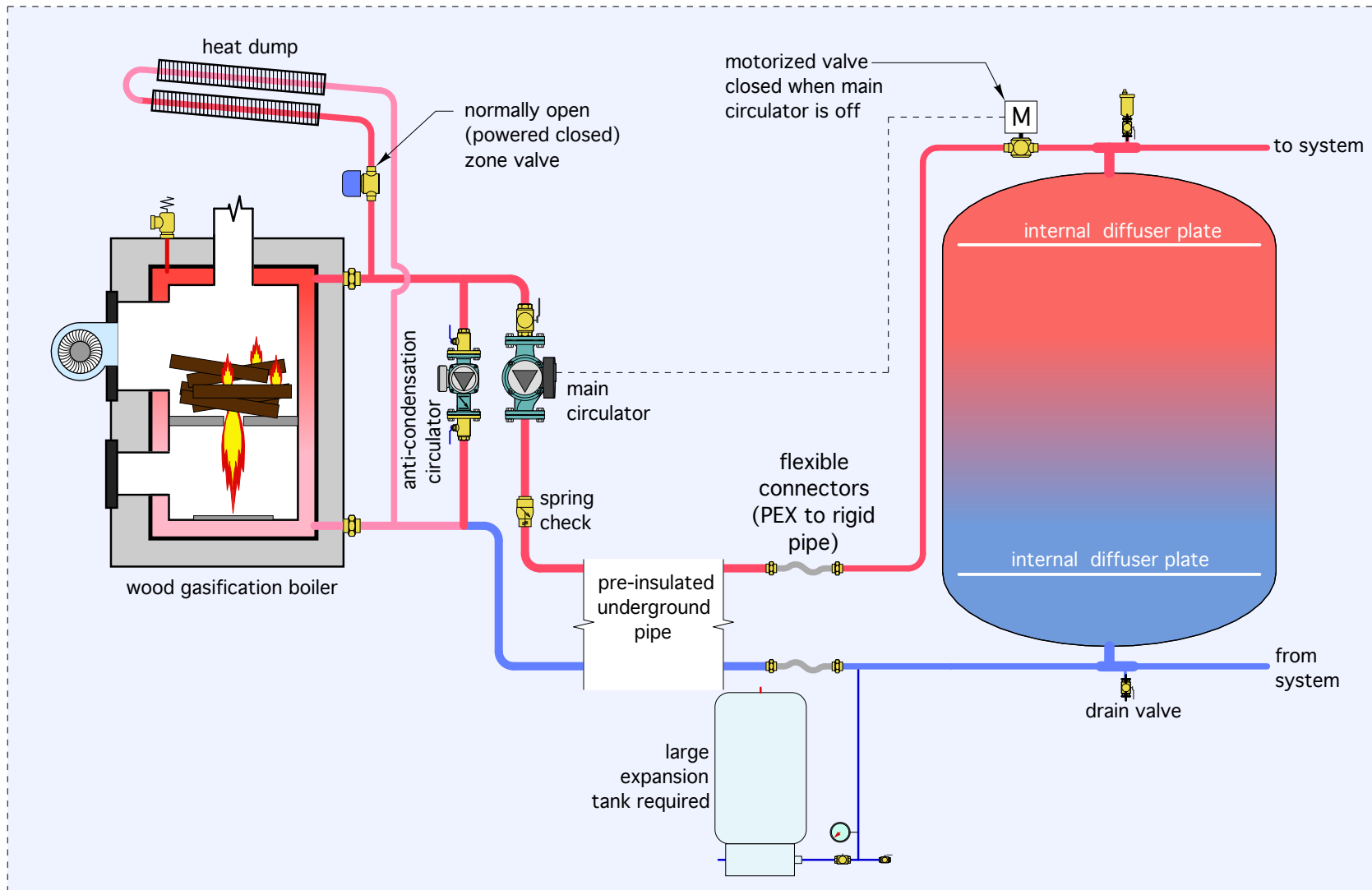

- eliminates cost of antifreeze, heat exchanger, HX to tank circulator
- Only if automatically started emergency electrical power is available

- System should also have alarm to indicate near freezing temperatures at boiler location

Freeze protection options for boiler in outdoor (unheated building)

OPTION 3: Use antifreeze in exterior portion of system

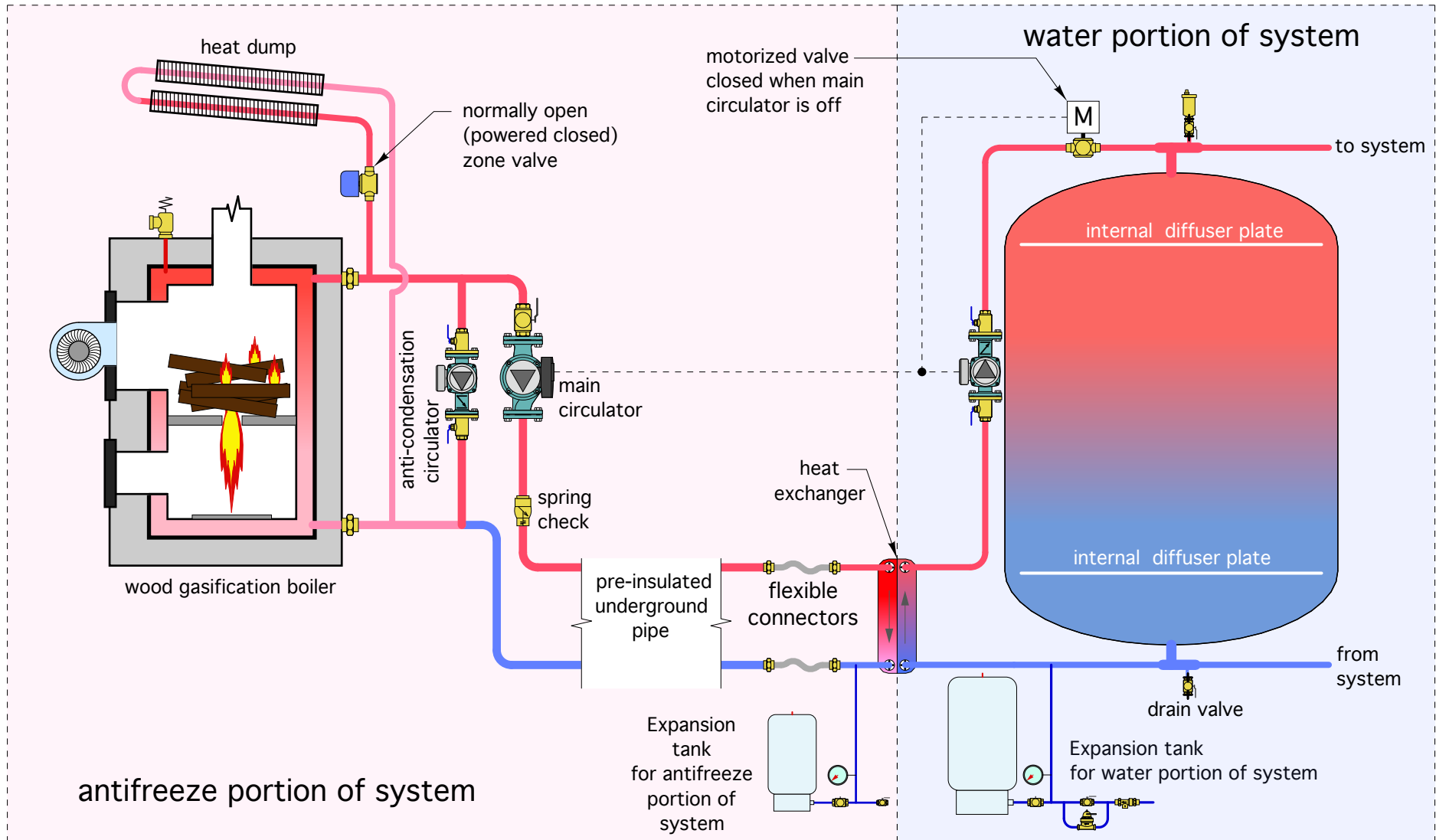

- reduces antifreeze volume, especially for thermal storage tank
- Adds cost of heat exchanger and HX to tank circulator

- Requires expansion tank on both sides of heat exchanger
- Slightly reduces water temperature to system for a given boiler outlet temperature

Freeze protection options for boiler in outdoor (unheated building)

OPTION 4: Use heat from auxiliary device to keep exterior portion of system above freezing.

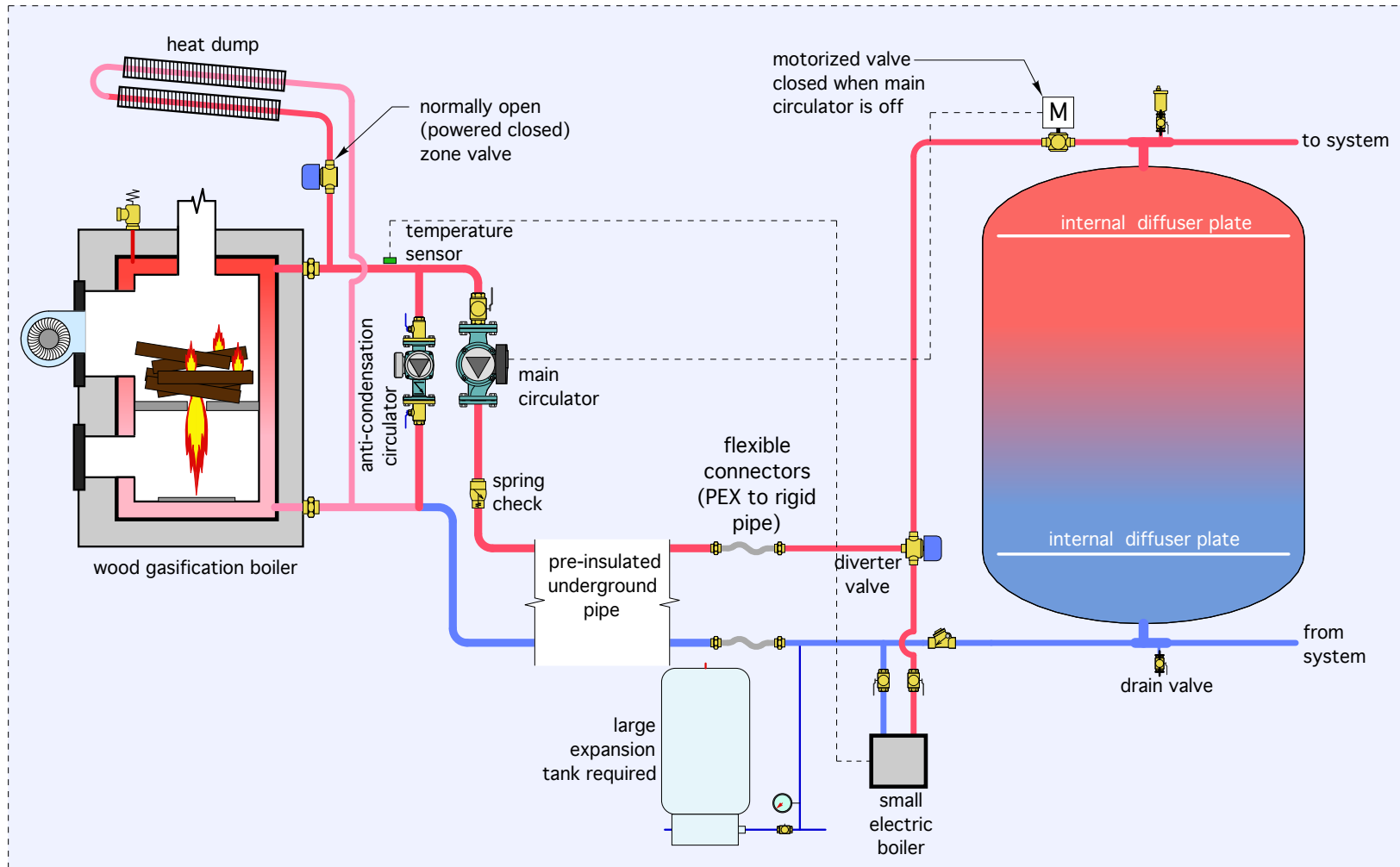

- Small electric boiler “trickles” heat into exterior portion of system, as necessary to keep exterior piping a few °F above freezing.
- Keep main circulator between boiler and building operating whenever freezing conditions might occur (gathers some heat from soil around buried piping).

Using Existing Underground Piping



Using existing underground piping

With few exceptions, the insulated underground piping installed for outdoor furnaces is 1" PEX

This existing piping should be evaluated if it is being considered for carrying heat from a new biomass boiler.

For a nominal working temperature drop of 20°F, the piping and circulator(s) should provide 1 gallon per minute (gpm) of water flow per 10,000 Btu/hr of rated biomass boiler capacity.

Head loss for 1" PEX carrying 150°F water

$$H_L = \left(\frac{L_{total}}{100} \right) (0.2034) f^{1.75}$$

- H_L = head loss (feet)
- L_{total} = round trip circuit length (feet)
- f = flow rate (gpm)



Using existing underground piping

Example: Find the head loss of a 1" PEX circuit with a total length of 350 feet, and carrying water at 10 gpm.

$$H_L = \left(\frac{L_{total}}{100} \right) (0.2034) f^{1.75} = \left(\frac{350}{100} \right) (0.2034) [10]^{1.75} = 40 \text{ feet}$$

Now - select a circulator that can produce at about 10 gpm at 40 feet of head.

published pump curves for Grundfos UPS 26-150

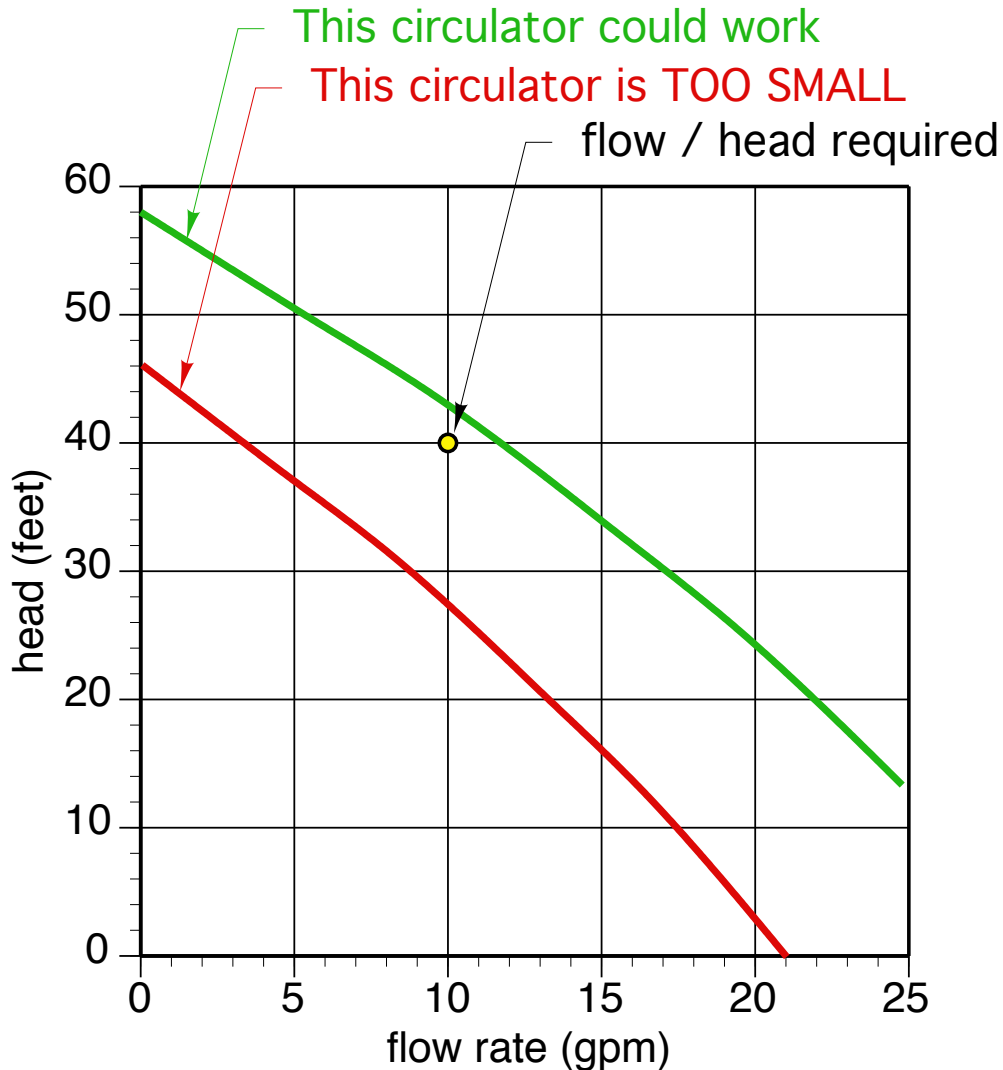
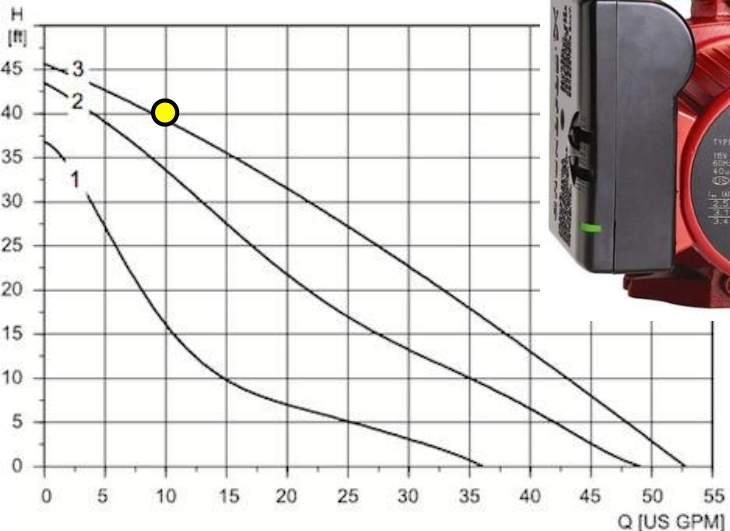

Using existing underground piping

When the head requirement is high, it's often best to use two circulators in "close coupled" series arrangement.

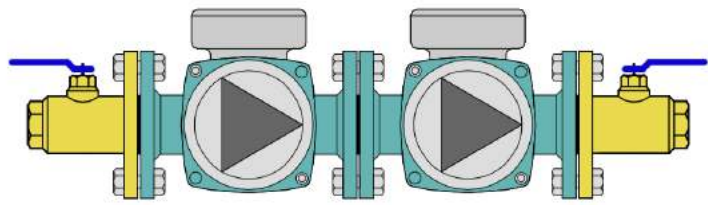

The pump curve for 2 circulators in series is found by doubling the head at each flow rate.

NOTE: 2 circulators in series will NOT double the flow rate in the circuit.

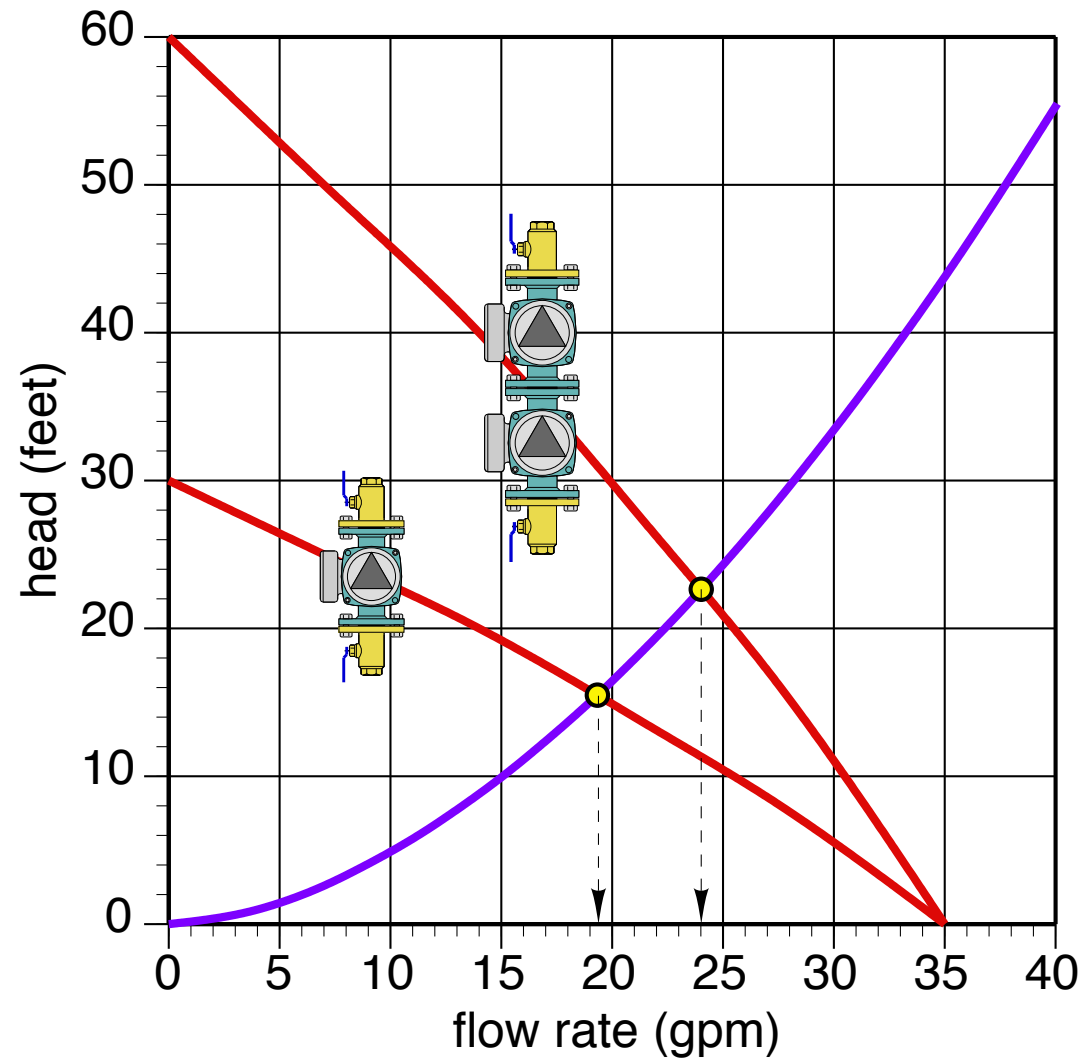

Using existing underground piping

The following graph plots head loss versus flow rate for 1" PEX tubing circuits having total (round trip) lengths from 100 to 500 feet.

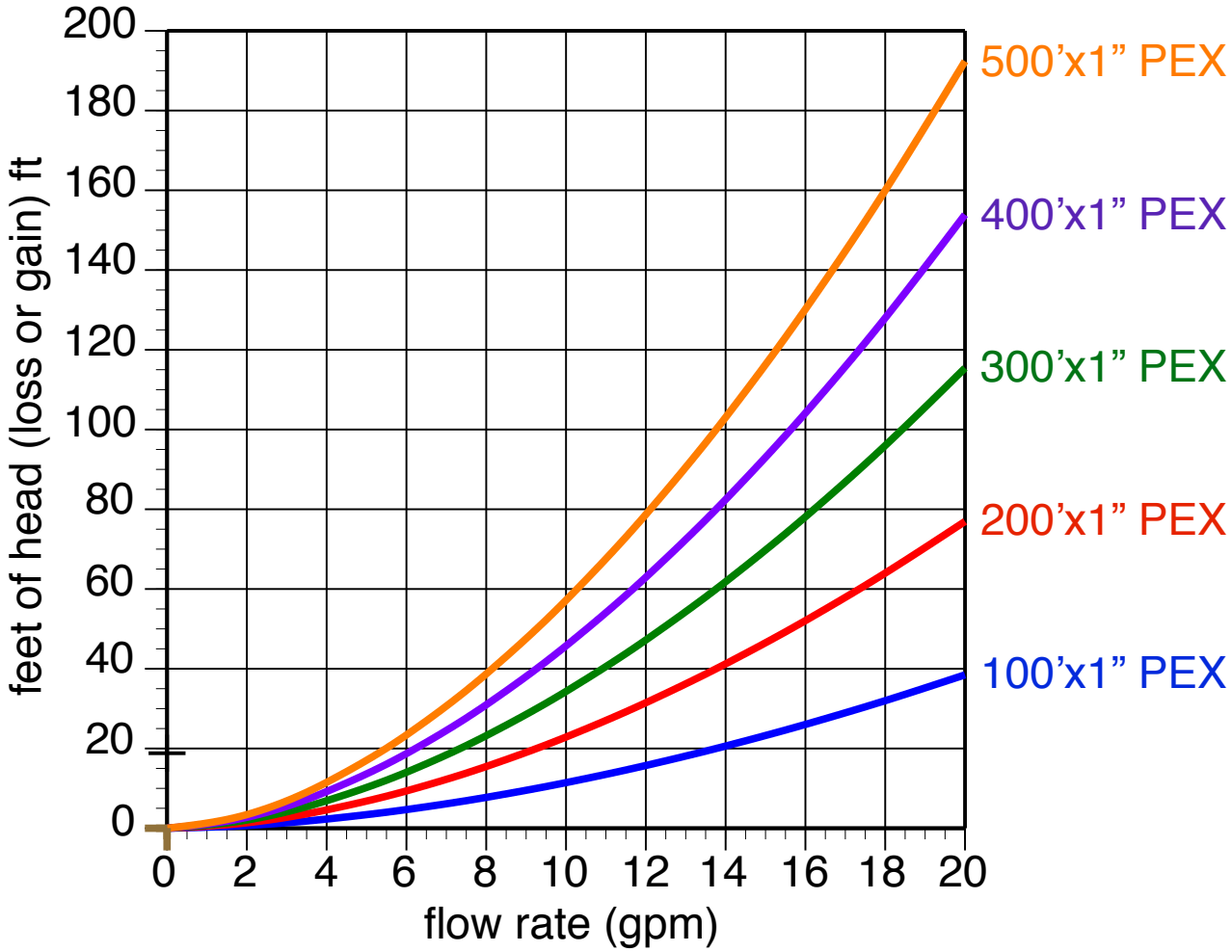

Using existing underground piping

The flow in any given circuit is found at the intersection of the pump curve and circuit head loss curve...



Grundfos UPS 26-99



Grundfos UPS 26-150

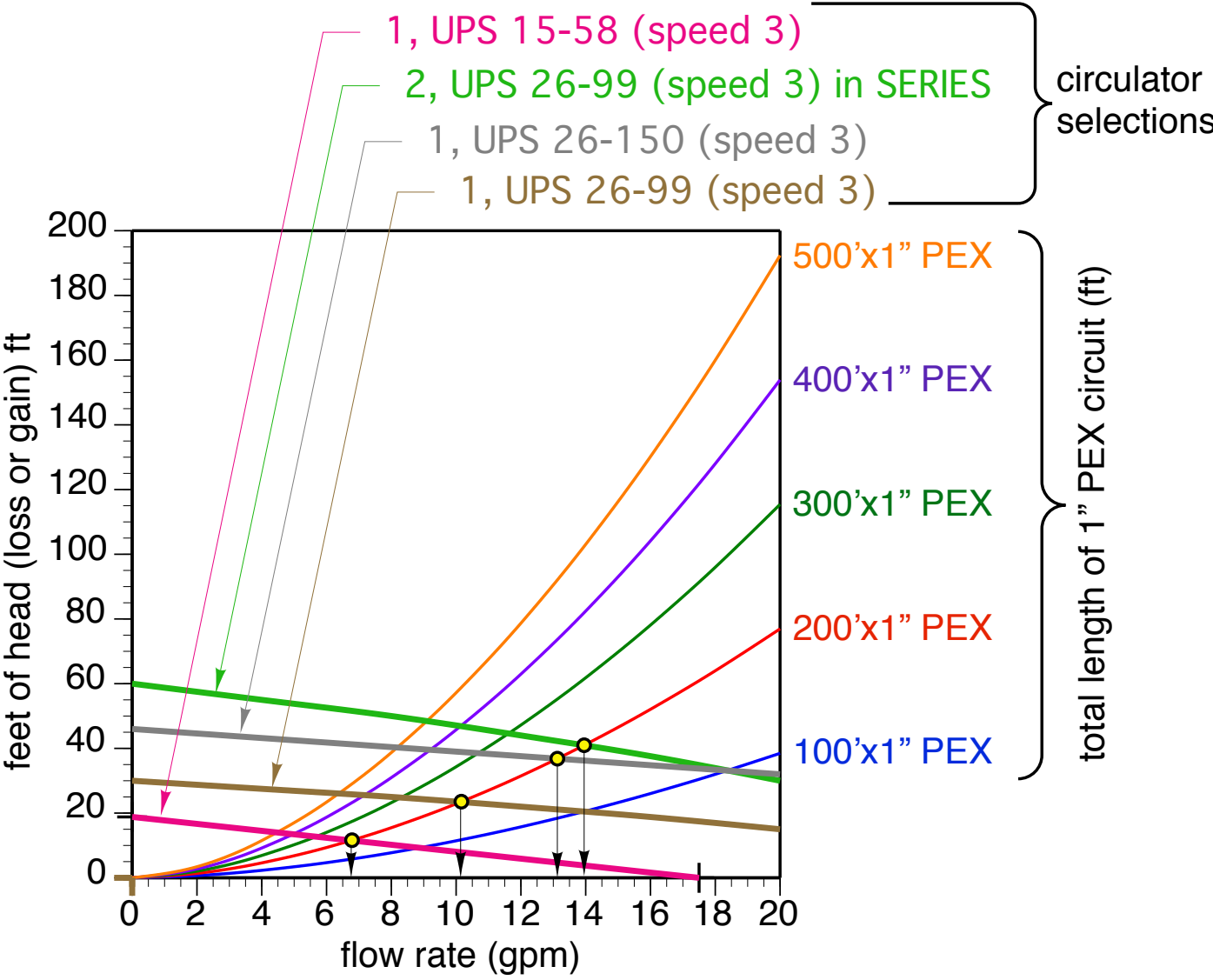

2 circulators in "close-coupled" series. **Double the head at each flow rate.**

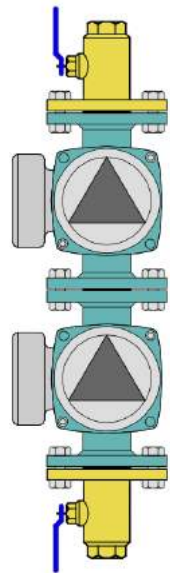

Example System

System using (unpressurized) buffer tank

- Closed loop boiler circuit
- Closed distribution system
- All external brazed plate heat exchangers
- DHW boost using electric tankless water heater

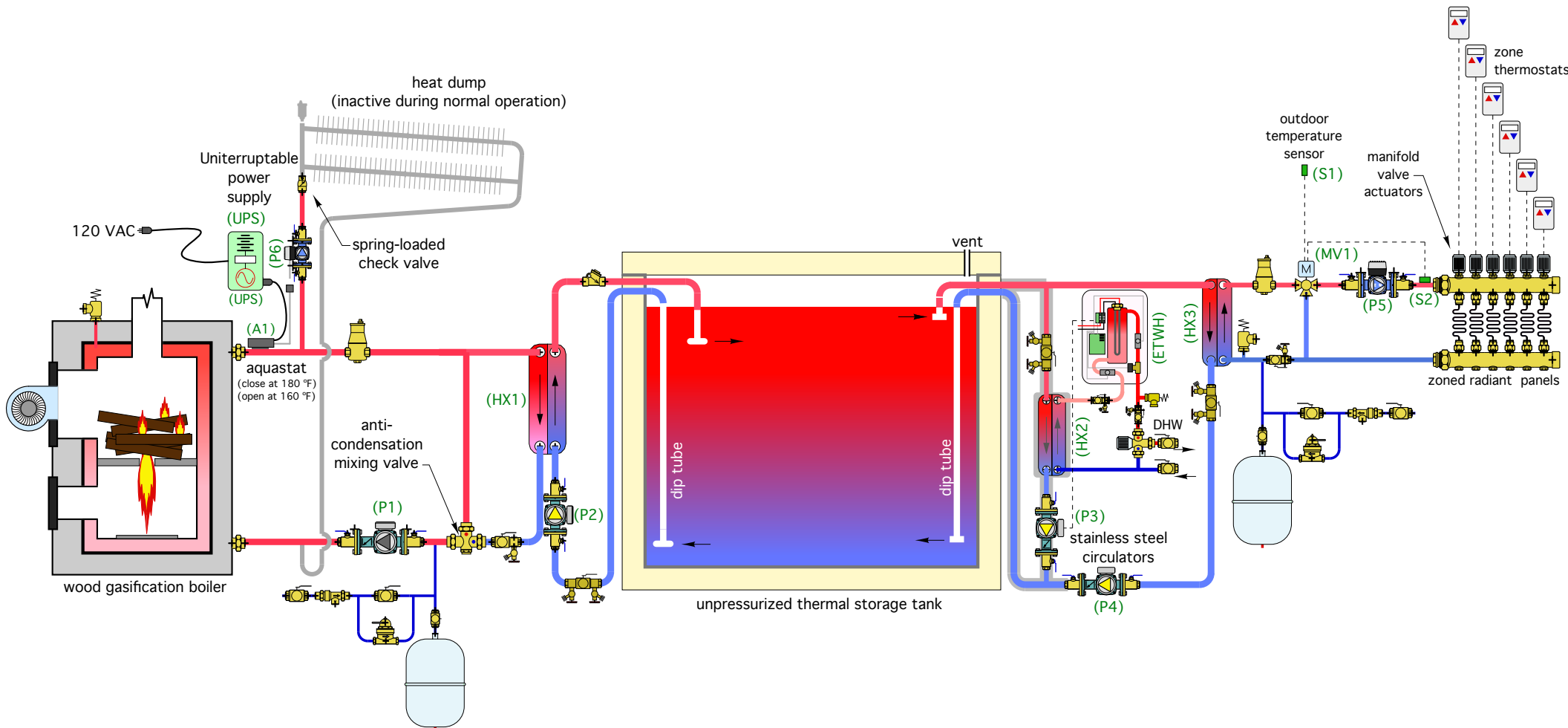

System using (unpressurized) buffer tank

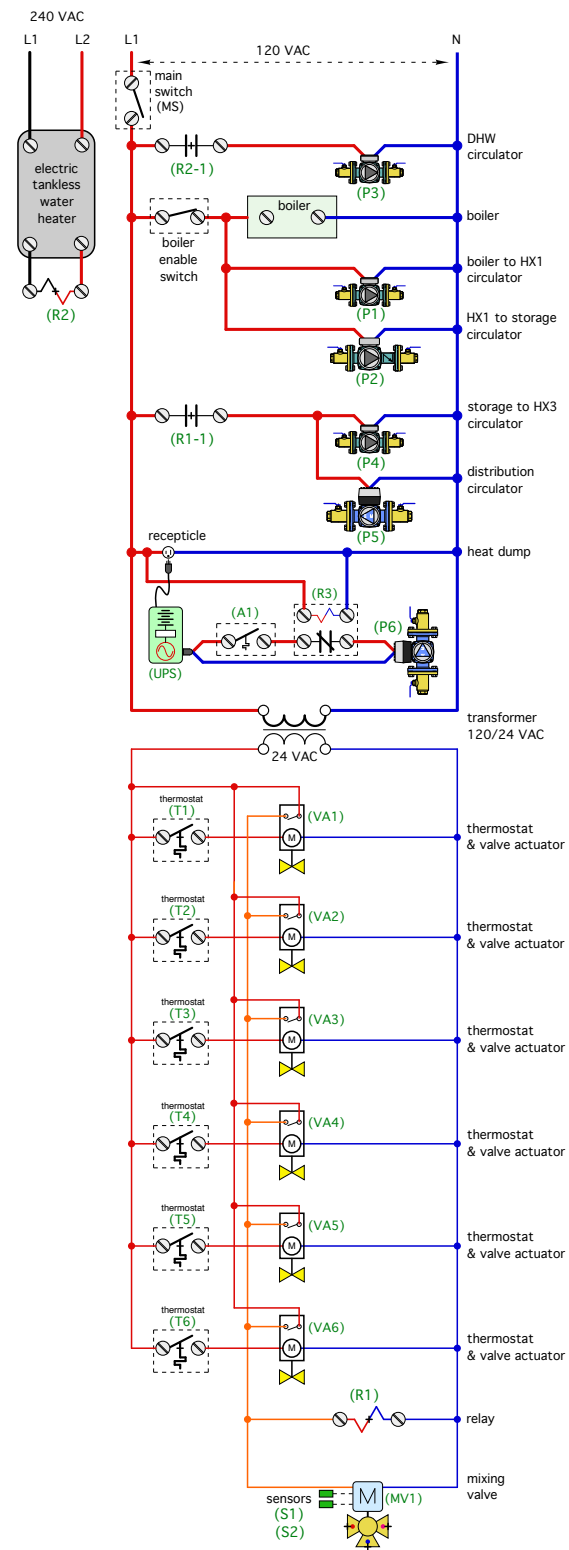
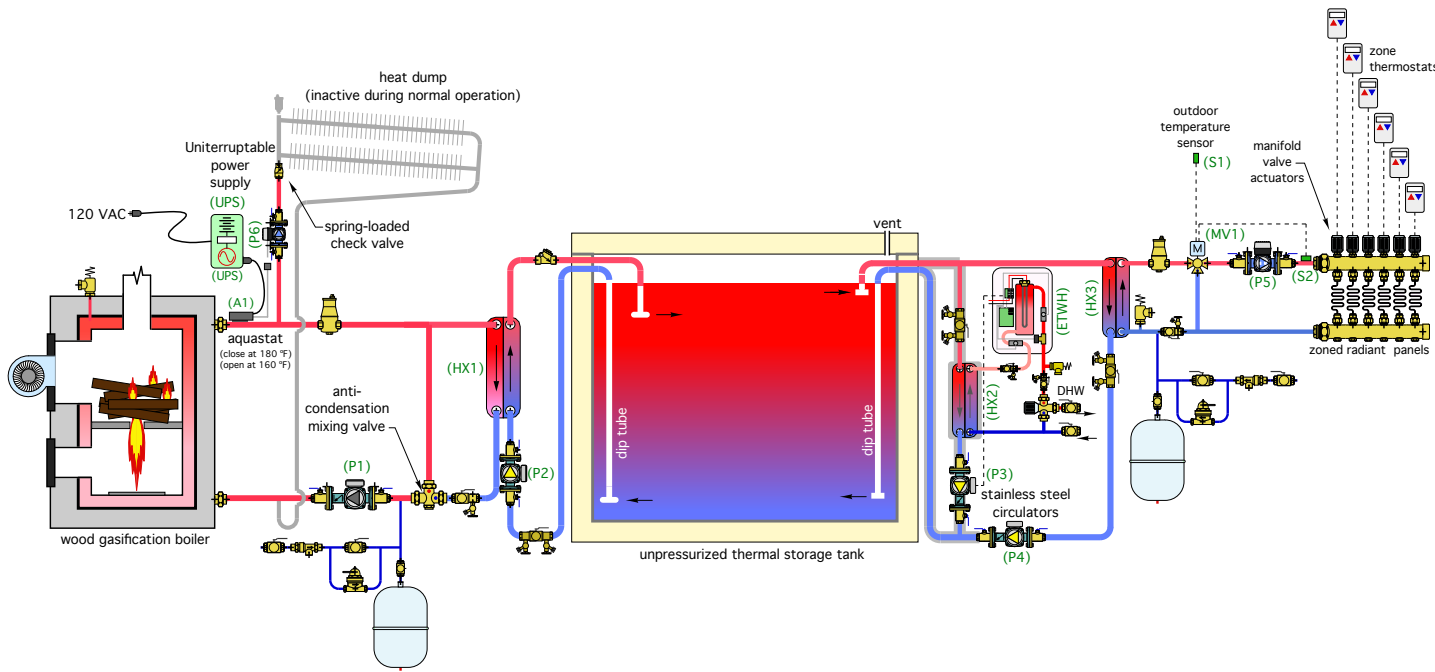

System using (unpressurized) buffer tank

Description of Operation:

Please read through this later....

1. Boiler operation: When the wood-gasification boiler is fired, the operator closes a switch on the boiler, that enables 120 VAC to be supplied to the boiler. This switch closure also supplies 120 VAC to circulators (P1) and (P2). Thus, flow between the boiler and heat exchanger (HX1), as well as between (HX1) and the thermal storage tank is enabled. As the temperature at the boiler outlet climbs, the 3-way thermostat valve (MVB) modulates to allow heat flow to heat exchanger (HX1) and onward to thermal storage, while also maintaining the boiler's inlet temperature above 130 °F (or whatever other temperature may be required) to prevent sustained flue gas condensation within the boiler.

2. Boiler overheat protection mode: In the event of a power failure, overheat protection is provided by an array of fin-tube elements sized to dissipate the residual heat within the boiler. At the onset of a power failure, 120 VAC is supplied from the uninterruptible power supply (UPS) to a normally open contact in aquastat (A1). This contact closes if the temperature at the boiler outlet rises to 180 °F or above. This passes 120 VAC from the UPS to a normally closed contact (R3-1). The coil of relay (R3) is energized whenever utility supplied power is available. Thus contact (R3-1) remains open unless a power outage occurs. The closure of (R3-1) supplies 120 VAC power from the (UPS) to operate circulator (P6), and thus create flow through the heat dump. If the temperature at the boiler outlet drops to 160 °F or lower, the contact in aquastat (A1) opens turning off circulator (P6). This conserves battery energy within the (UPS) when the boiler temperature is not high enough to justify operating the heat dump.

3. Space heating mode: Upon a call from any of the thermostats (T1...T6), 24 VAC is passed to the associated manifold valve actuators (VA1...VA6). When any one or more of these valve actuators reach their fully open position, an end switch within the valve actuator closes to pass 24 VAC to the coil of relay (R1), and motorized mixing valve (MV1). A normally open contact (R1-1) closes to supply 120 VAC to circulators (P4) and (P5). Circulator (P4) creates flow between the thermal storage tank, and heat exchanger (HX3). Circulator (P5) is a variable speed pressure regulated circulator that adjusts its speed to maintain a constant differential pressure across the distribution manifold as the manifold valve actuators open and close. The motorized mixing valve (MV1) measure the outdoor temperature at sensor (S1), and uses this temperature, along with its settings, to calculate the necessary target supply water temperature to the distribution system. It compares the target supply temperature to the supply temperature measured by sensor (S2), and adjusts the hot water and return water flow rates into the valve to maintain the temperature at sensor (S2) as close to the target temperature as possible.

4. Domestic water heating mode: Whenever there is a demand for domestic hot water of 0.6 gpm or higher, a flow switch within the electric tankless water heater (ETWH) closes. This closure supplies 240 VAC to the coil of relay (R2). The normally open contacts (R2-1) close to turn on circulator (P3), which circulates heated water from the upper portion of the thermal storage tank, through the primary side of the domestic water heat exchanger (HX2). The domestic water leaving (HX2) is either preheated, or fully heated, depending on the temperature in the upper portion of the thermal storage tank. This water passes into the thermostatically controlled tankless water heater (ETWH) which measures its inlet temperature. The electronics within this heater control the electrical power supplied to the heat elements based on the necessary temperature rise (if any) to achieve the set domestic hot water temperature. If the water entering the tankless heater is already at or above the setpoint temperature, the elements are not turned on. All heated water leaving the tankless heater flows into an ASSE1017 rated mixing valve to ensure a safe delivery temperature to the fixtures. Whenever the demand for domestic hot water drops below 0.4 gpm, circulator (P3) and the tankless electric water heater are turned off.

Thanks for attending today's webinar

Upcoming RHNH training opportunities



WEBINARS:

September 12, 2017 1:00 PM Eastern time, 1.0 AIA continuing education credit

Title: Integrating thermal storage with biomass boiler

Description: This webinar explains how use of thermal storage enhances the operating characteristics of pellet-fired boilers and cordwood gasification boilers in residential and light commercial applications. It discusses how thermal storage should be sized, as well as optimal piping and control strategies to maximize the effectiveness of thermal storage. It also describes situations that should be avoided.

November 16, 2017 1:00 PM Eastern time, 1.0 AIA continuing education credit

Title: Best practices for venting and chimneys on cordwood gasification and pellet boilers

Description: this webinar describes the best options for safely and efficiently connection pellet-fired boilers and cordwood gasification boilers to chimney systems. It discusses material options, draft regulation, and proper procedures for sealing venting system components against flue gas leakage.

FULL DAY Training Workshop:

Thursday, October 10, 2017 8:00 a.m. – 5:00 p.m. SUNY Morrisville 80 Eaton Street Design Center Room #205
(next to campus entrance) Morrisville, NY 13408, 7.0 AIA continuing education credits

<https://www.regonline.com/registration/Checkin.aspx?EventID=1958203>



NYSERDA
Sponsored



Questions?

Credit(s) earned on completion of this course will be reported to **AIA CES** for AIA members. Certificates of Completion for both AIA members and non-AIA members are available upon request.

This course is registered with **AIA CES** for continuing professional education. As such, it does not include content that may be deemed or construed to be an approval or endorsement by the AIA of any material of construction or any method or manner of handling, using, distributing, or dealing in any material or product.

Questions related to specific materials, methods, and services will be addressed at the conclusion of this presentation.

