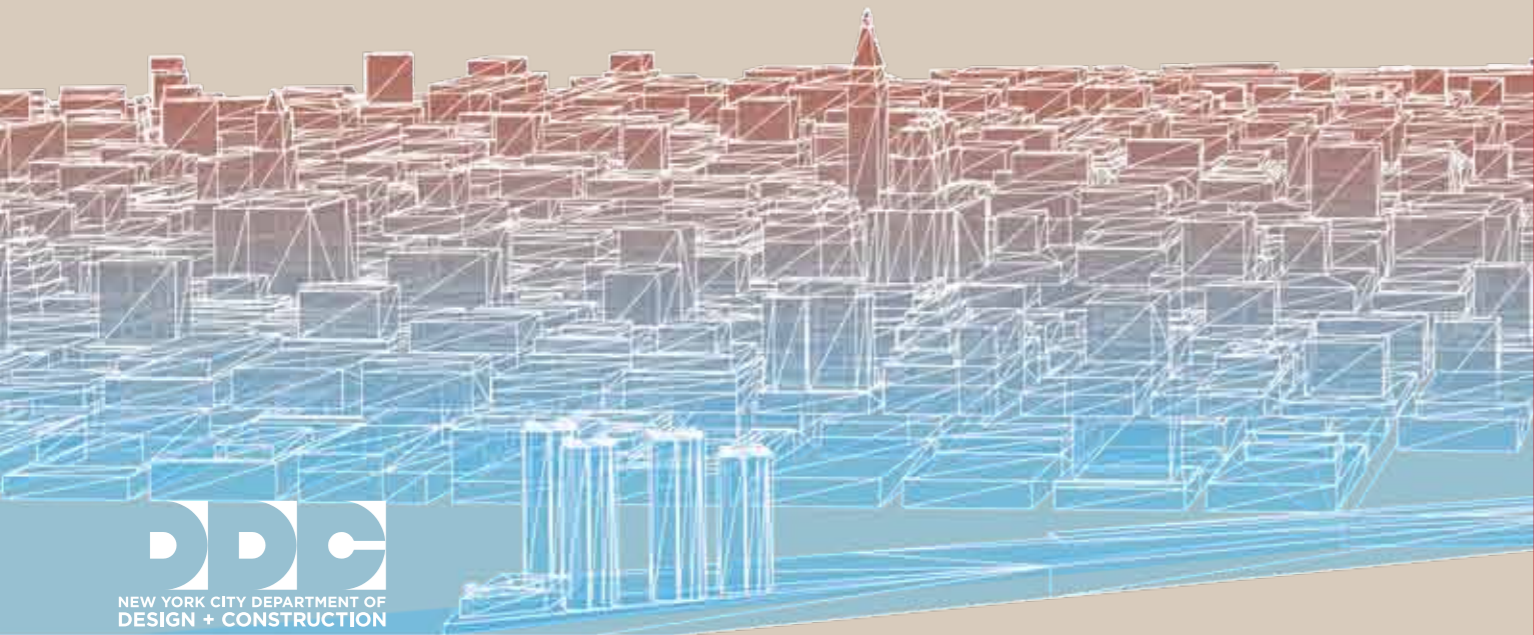


Geothermal Heat Pump Manual

A Design and Installation Guide for New York City

Geothermal Heat Pump Manual

A Design and Installation Guide for New York City



Geothermal Heat Pump Systems Manual



Preface

The Department of Design and Construction's Office of Sustainable Design has been a leader in developing high performing built environments that emphasize energy-saving technologies such as geothermal heat pumps.

As an alternative to costly, conventional energy sources, geothermal heat pumps use onsite energy from underground temperature differentials to heat and cool buildings with rewarding reductions in energy use and greenhouse gas emissions throughout the life of a building. Although practical, the application of these systems can be complex, and this publication, an update to our first manual published in 2002, provides a comprehensive background on the subject and addresses potential challenges that may arise during the design and construction of this technology. In addition, it provides professionals with the necessary tools for understanding the nature of New York City's geology and how that information can be utilized to integrate geothermal heat pumps into a sustainable project.

New York City continues to address greenhouse gas emissions and has exceeded a 13% reduction over 2005 levels. Mayor Bloomberg's PlaNYC 2030 ambitious goal of a 30% reduction by 2030, however, will be challenged by population increases and unexpected changes in climate. Geothermal heat pumps can play a substantial role in reaching this advanced goal.

Sincerely,

David J. Burney, FAIA



David J. Burney, FAIA
Commissioner, New York City Department of
Design and Construction
June 2012

Geothermal Heat Pump Systems Manual

A Design and Installation Guide for New York City Projects

Contents

1	Introduction	008	5	Construction	118
1.0	List of Abbreviations	009	5.0	List of Abbreviations	119
1.1	Introduction	010	5.1	Construction	120
1.2	Advantages and Applications	016	5.2	Contractor Training and Certification	121
1.3	Typical Workflow	017	5.3	Construction Logistics	122
1.4	Project Team Members	020	5.4	Regulatory Requirements	126
1.5	GHP Project Considerations	022	5.5	GRCO Monitoring and Coordination	131
1.6	GHP Screening	023	5.6	GRCO Best Practices	133
<hr/>			5.7	System Start-Up and Balancing	134
2	Geothermal Heat Pump System Components	028	5.8	Commissioning	136
2.0	List of Abbreviations	029	<hr/>		
2.1	GHP System Components	030	6	Operation and Maintenance	138
2.2	Geothermal Heat Pumps	032	6.0	List of Abbreviations	139
2.3	Ground Couplings	038	6.1	Operations and Maintenance	140
<hr/>			6.2	Operational Considerations	142
3	Schematic Design	060	6.3	Maintenance	144
3.0	List of Abbreviations	061	<hr/>		
3.1	Schematic Design	062	7	Case Studies	156
3.2	Geology and Hydrogeology	063	Brooklyn Children’s Museum	158	
3.3	Site Investigation	073	Queens Botanical Garden	160	
3.4	Feasibility Analysis	078	Weeksville Heritage Center	162	
<hr/>			Lion House at the Bronx Zoo	164	
4	Design	092	Staten Island Museum at Snug Harbor	166	
4.0	List of Abbreviations	093	<hr/>		
4.1	GHP System Design	094	 Appendices		168
4.2	Load Analysis and Sizing	095	 Hydrogeology and Its Limiting Factors on GHP Systems		168
4.3	GHP Configurations	097	 Field Testing		178
4.4	Ratings and Performance	103	 Supplemental Regulatory Requirements		186
4.5	Refrigerant Types	105	 Regulatory Agencies Contact Information Requirements and Resources		192
4.6	Antifreeze Types	106	 Sample Specifications for Modular Water-to-Air and Water-to-Water Heat Pumps		198
4.7	Manifold System Design	107	 Sample of Pre-Functional Checklist and Start-Up Checklist		215
4.8	GRCO Design Considerations	110	 Selected Glossary and References		230
4.9	Hybrid Systems	114			
4.10	System Redundancy	116			

Abbreviations Used Throughout Text

Geothermal Technology

AHU	Air Handling Unit
BMS	Building Management System
COP	Coefficient of Performance
Cx	Commissioning
DTB	Depth to Bedrock
DTW	Depth to Ground Water
EER	Energy Efficiency Ratio
EWT	Entering Water Temperature
FCU	Fan Coil Unit
GHP	Geothermal Heat Pump
GRCO	Ground Coupling
HTF	Heat Transfer Fluid
HVAC	Heating, Ventilation, and Air Conditioning
HX	Heat Exchanger
IRB	Iron-Related Bacteria
O&M	Operations and Maintenance
ODP	Ozone Depletion Potential
SCW	Standing Column Well
VFD	Variable Frequency Drive

Project Team Members

A	Architect
CE	Civil Engineer
CM	Construction Manager
CxA	Commissioning Agent
DC	Drilling Contractor
EC	Electrical Contractor
GC	General Contractor
GEO	Geologist/Hydrogeologist
GTE	Geotechnical Engineer
GTH	Geothermal Engineer
LEED	Sustainability/LEED Consultant
MC	Mechanical Contractor
MEP	Mechanical, Electrical, and Plumbing Engineer

Organizations

ACCA	Air Conditioning Contractors Association
AHRI	Air Conditioning, Heating and Refrigeration Institute
ASHRAE	American Society for Heating, Refrigerating and Air-conditioning Engineers
IGSHPA	International Ground Source Heat Pump Association

LEED Leadership in Energy and Environmental Design

MTA Metropolitan Transportation Authority

NGWA National Ground Water Association

NYCDDC New York City Department of Design and Construction

NYCDEP New York City Department of Environmental Protection

NYCDOB New York City Department of Buildings

NYCDOH New York City Department of Health

NYCDOT New York City Department of Transportation

NYSDEC New York State Department of Environmental Conservation

PANYNJ Port Authority of New York and New Jersey

UIC Underground Injection Control

USEPA U.S. Environmental Protection Agency

USGBC US Green Building Council

USGS United States Geological Survey

Introduction



1.0 List of Abbreviations

BMS

Building
Management
System

COP

Coefficient of
Performance

GHP

Geothermal
Heat Pump

GRCO

Ground Coupling

HDPE

High-Density
Polyethylene

HVAC

Heating, Ventilation,
and Air Conditioning

HX

Heat Exchanger

SCW

Standing Column Well

1.1 Introduction

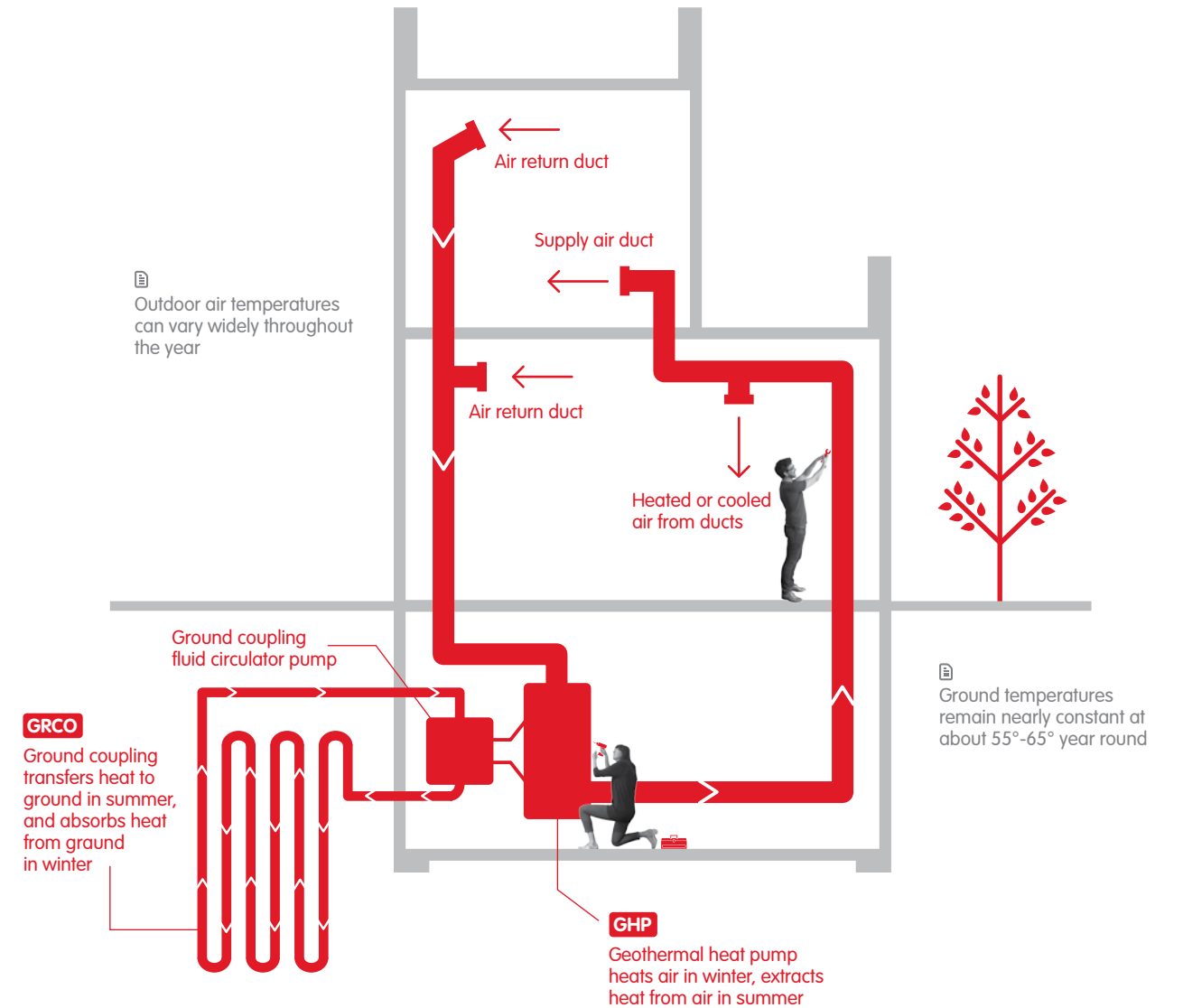
In the search for renewable resources, geothermal energy quickly emerges as a clean and widely available energy source. Although geothermal energy is frequently associated with electricity generation in the western United States, thermal energy at varying depths can be used in numerous applications. The type of geothermal technology that is gaining acceptance in the New York City area takes advantage of the stable temperatures found in the ground and natural aquifers for heating and cooling buildings.

Geothermal heat pump (GHP) systems are a growing sector in the space conditioning market as energy efficiency has become a critical issue in building operations. GHPs have been successfully operated for decades in virtually every building type for both heating and cooling. However, within New York City, GHP use is relatively new. Although a type of GHP system called the open loop has been used for air conditioning as well as industrial process water for many decades in Brooklyn and Queens, the first systems for space conditioning only became operational within the last fifteen years. As part of its high performance building mandate, the New York City Department of Design and Construction (NYCDDC) was the first city agency to investigate and incorporate GHP technology into its projects.

The primary difference between a GHP system and a conventional heating, ventilation and air conditioning (HVAC) system, is the combination of two distinct components, the GHP installed within the building and the ground coupling (GRCO) installed outdoors. While the mechanical piping and ductwork are the same in both system types, the GHP system essentially couples the building's heat pump with the ground serving as the source or sink for heat transfer. A simplified GHP system layout is illustrated in Figure 1.1.

Ground temperatures for wells drilled throughout New York City range from 55–65 °F, which is already close to design temperatures for space conditioning. In the heat pump systems, the coefficient of performance (COP) improves as the temperature differential is minimized, indicating an increase in efficiency. Therefore, a GHP requires less electrical energy to provide the same heating and cooling than conventional air or water based HVAC equipment. With energy costs continuing to rise, GHP systems become a clear choice in helping to reduce energy consumption in building operations.

Figure 1.1
Simplified GHP System Layout



Introduction

Overview of Components

GHPs are a type of heat pump that uses the **GRCO** to transfer heat energy to and from the ground. The units can be installed and connected to distribution systems in the same manner as water-to-water or water-to-air heat pumps. An additional device called a de-superheater can be integrated to heat domestic hot water with waste heat normally rejected back into the ground.

The three primary types of GRCO's employed in New York City are open loop, closed loop and **standing column wells SCW**. Depending on the site's geology and other subsurface conditions, the GRCO can be a series of wells or plastic pipes grouted in boreholes. Despite construction differences, all GRCOs use a circulating liquid, either ground water or an anti-freeze solution in closed piping, to transfer heat energy between the building and the ground.

Closed loop systems, **Figure 1.2.1**, circulate water with an antifreeze solution in a network of closed piping installed in the ground. Open loop systems, **Figure 1.2.2**, use ground water pumped from a supply well to transfer heat and returns the water back to the ground through diffusion wells. Standing column wells, **Figure 1.2.3**, also use ground water but rely on smaller amounts within a very deep well to exchange heat with the surrounding bedrock.

Figure 1.2.1
Closed Loop System

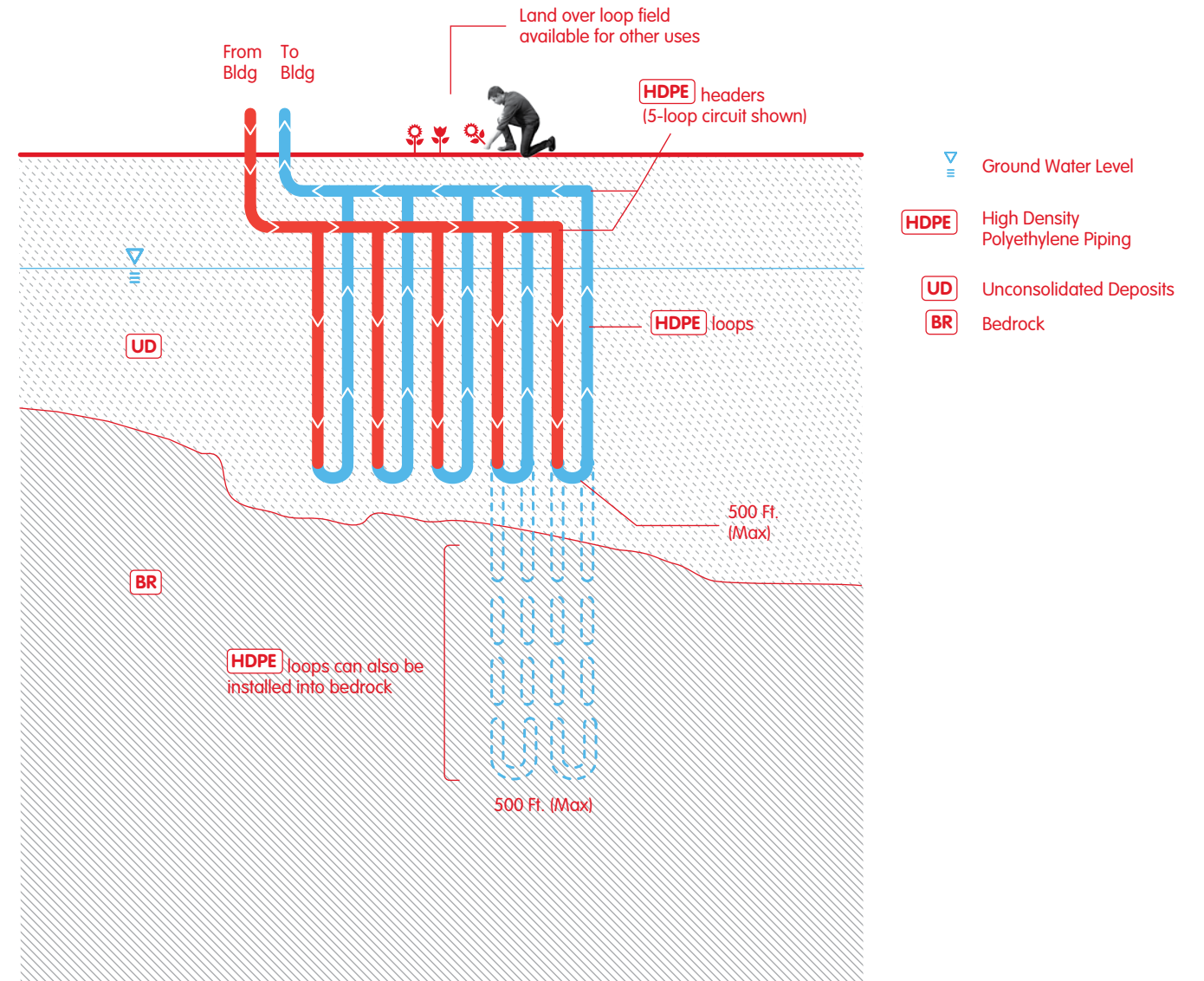
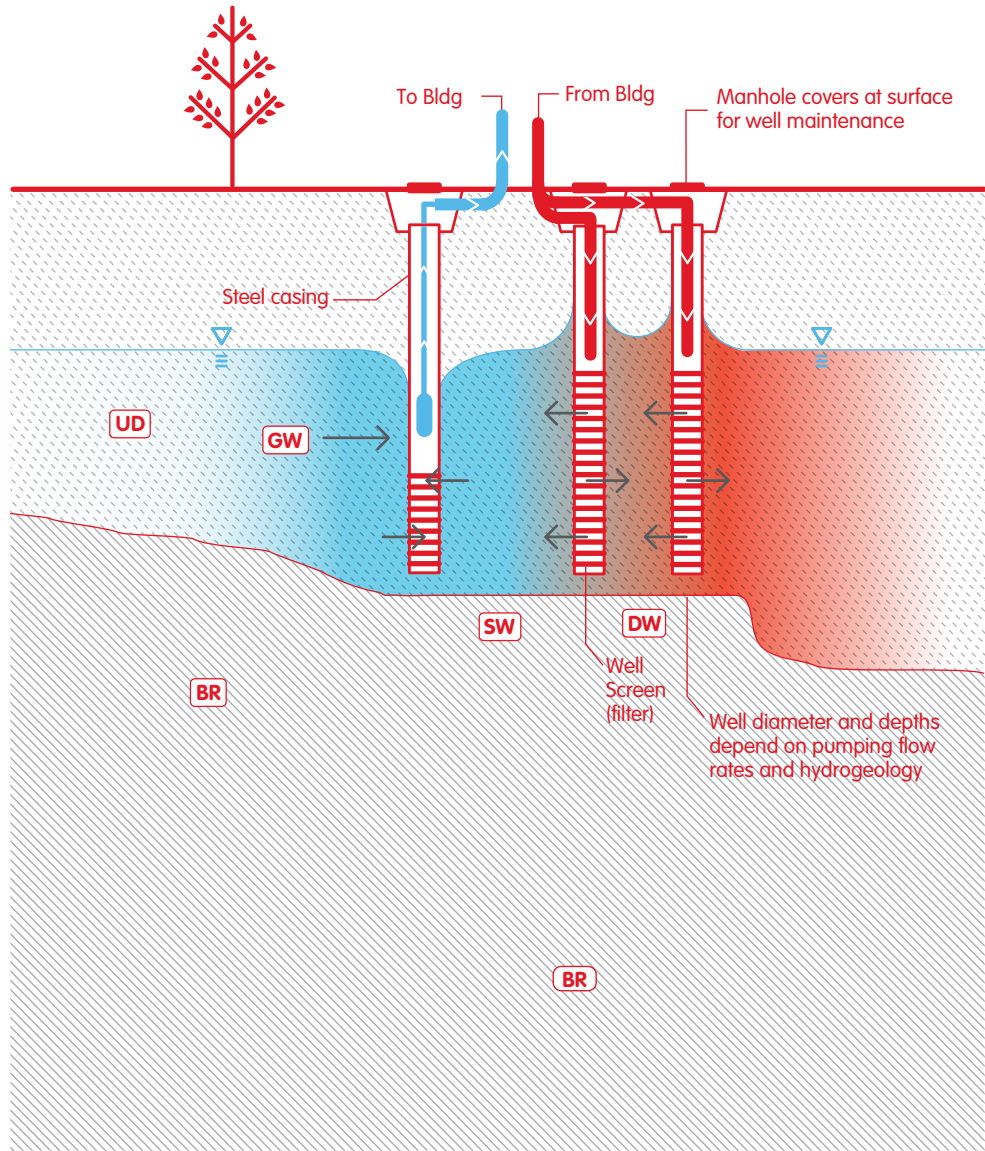


Figure shown in cooling mode.

Figure 1.2.2

Open Loop System







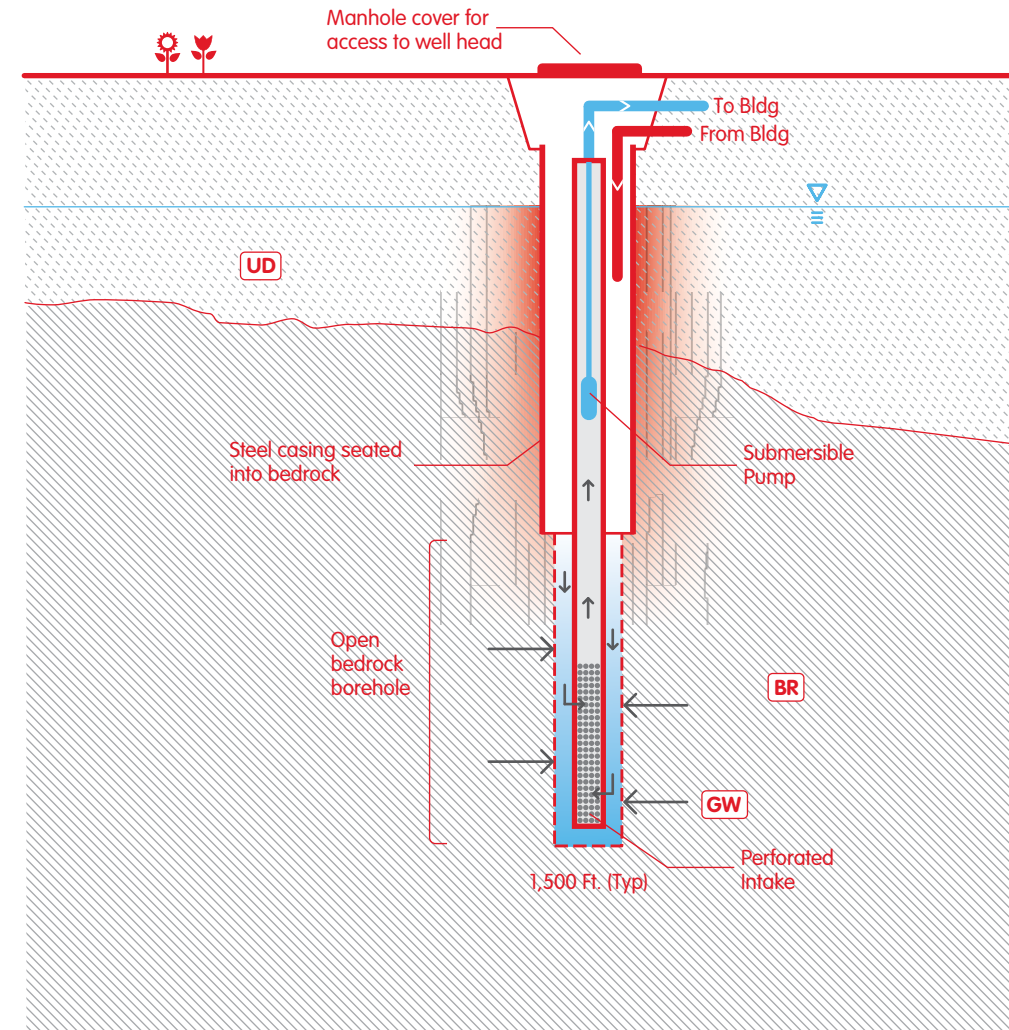
-  Ground Water Level
-  Ground Water
-  Bedrock
-  Unconsolidated Deposits
-  Diffusion Wells
-  Supply Well

Figure shown in cooling mode.

Figure 1.2.3

Standing Column Well System



-  Ground Water Level
-  Ground Water
-  Bedrock
-  Unconsolidated Deposits

Figure shown in cooling mode.

1.2 Advantages and Applications

Advantages

The general advantages of GHPs over conventional HVAC systems include:

Low operating costs and maintenance

No exposed outdoor equipment subject to weather and vandalism

Elimination of rooftop equipment

Reduced space demands in mechanical rooms

Level seasonal electric demand and lower utility demand rate

Possible elimination of on-site fuel storage and combustion

Reduction of on-site fossil fuel emissions

Possible elimination of flue for heating

Potential for integrated water heating

Most conventional HVAC systems rely on the use of separate mechanical equipment for heating and cooling, but a GHP can serve both functions. The units are designed and fabricated with fewer operating components that have an extended useful lifespan. GHP systems are also capable of providing independent climate control for many spaces by simultaneously providing heating and cooling to different zones.

In older cities like New York, GHP systems are an ideal option for historic buildings, which may have restrictions on rooftop unit placement because of preservation or zoning requirements. GHPs and GRCO may also eliminate the noisy rooftop or pad-mounted exterior cooling equipment.

GHPs may require fewer annual inspections and operating permits from local authorities as compared to conventional HVAC systems, reducing building maintenance staff time and operational costs. When used for heating, GHPs also have the additional benefit of reducing emissions at the site by eliminating or reducing the size of fuel-fired boilers. Without cooling towers, there is a significant water reduction and cost savings as algacides or other microbiological control programs are no longer needed.

Applications

GHPs can be used in numerous applications, from new construction to existing buildings. While all building types can incorporate GHPs, large commercial buildings and facilities with varying space conditioning requirements particularly benefit from the system's efficiencies. Completed projects managed by NYCDDC that include GHP systems include a zoo exhibit renovation, a new museum, and a new multi-purpose building for a botanical garden. Additionally, two buildings currently in construction that will employ a GHP system include renovation of a landmark building into a museum and a new education center for a not-for-profit organization.

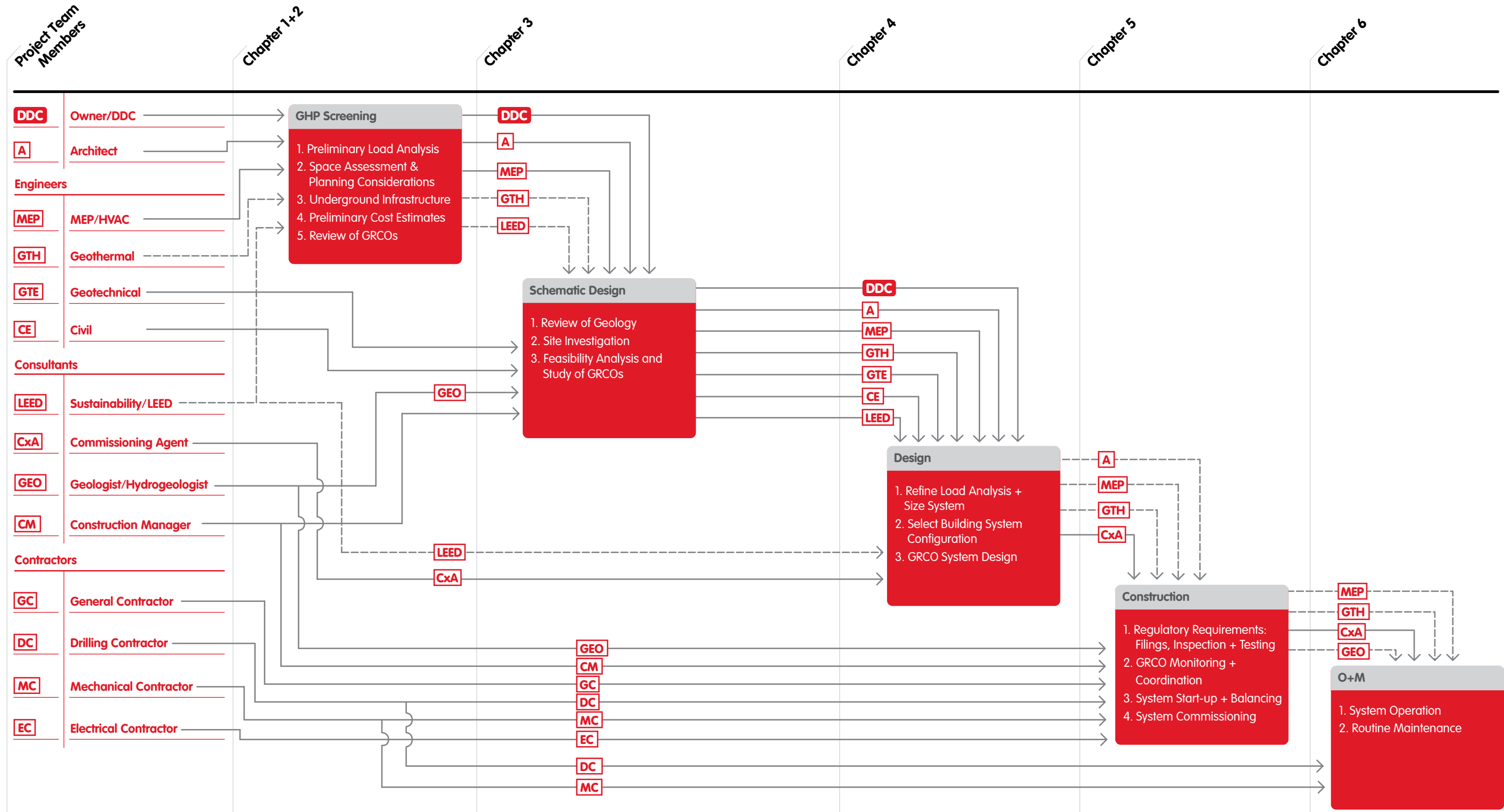
1.3 Typical Workflow

Figure 1.3 illustrates the typical workflow of a large commercial project employing a GHP system. The chart highlights the requisite tasks at each phase and how each team member interacts. A well designed GHP system begins with early project screening to verify that the system is appropriate based on existing site conditions and other project constraints. Unlike projects with conventional HVAC systems, additional research, field investigations and testing not customarily performed will be necessary during design and construction. Proper operation and maintenance will ensure that system performance is optimized and benefit of energy efficiency is achieved.

The chart also reflects NYCDDC experience with GHPs, and incorporates the agency's role throughout a project as well as issues from managing projects in New York City. Actual project team and milestones will vary according to project location, size, budget, and local laws and regulations.

Figure 1.3
Typical Workflow

→ Direct Involvement/Responsibility
 - - - Limited/As-Needed Advisory Role



1.4

Project Team Members

Since **GHP** systems are still relatively new in the city, there may be a limited pool of engineers, consultants, and contractors with sufficient experience in performing feasibility analyses, planning, design work, installation and system operation and maintenance. As a result, specialized professional expertise and construction experience from geothermal engineers, geologists, and hydrogeologists are essential for a successful project.

Architect **A**

The architect serves as the lead consultant who coordinates with various professionals, from initial project screening through design development and construction administration. Construction is frequently managed by the construction manager **CM** or general contractor **GC**, and is overseen by the architect.

Mechanical, Electrical, and Plumbing **MEP** Engineer

The MEP engineers are involved early in the project to advise on minimizing energy demand, devising specific energy efficiency measures and optimizing building operation. In particular, the mechanical engineer develops the building heating and cooling loads used to determine capacity and assess potential imbalance as well as design the interior distribution from the GHP in coordination with the architect and other trades. The MEP may also prepare a feasibility study and conduct a life-cycle cost analysis. Some MEP engineers have the requisite experience and training to size and design a closed loop GRCO, but most will defer design of an open loop or standing column well field to a well designer who might be a geothermal engineer, geologist, hydrogeologist, or geotechnical engineer.

Geothermal Engineer **GTH**

The geothermal engineer has specialized training and experience in the analysis, design, and installation of GHP systems. They typically act in advisory or review roles in project screening and system selection, and serve as a consultant during design, construction and system operation. Some geothermal engineers are also mechanical engineers who can serve as the engineer-of-record for the building design in addition to the GRCO. Additional assistance from a trained geologist/hydrogeologist should be used for an open loop or standing column well field design.

Geologist/Hydrogeologist **GEO**

The geologist/hydrogeologist is responsible for subsurface investigations and should guide the GHP design and implement a field testing program with the drilling contractor. They are a critical team member in preparing permit filings and inspecting drilling and GRCO installation. Some geologist/hydrogeologist firms can size and design the ground coupling and may have geothermal engineers on their staff.

Geotechnical Engineer **GTE**

The geotechnical engineer is responsible for subsurface analysis required for building foundation and other subsurface structural design. Firms having experience with GHP systems can help size and design the system while working closely with the MEP and geothermal engineers.

Project Team Members

Civil Engineer **CE**

The civil engineer is responsible for site grading and drainage design, including site water and wastewater piping, utility connections, underground conduits, and other subsurface structures. They should coordinate closely with the well or loop field designer during design to avoid conflicts between these structures and the GRCO.

Sustainability/LEED Consultant **LEED**

The sustainability/LEED consultant advises on overall sustainability goals, LEED certification requirements, and performs building energy modeling as needed. Ideally, they should have experience analyzing and modeling GHP systems for energy performance.

Commissioning Agent **CxA**

The commissioning agent verifies and documents that the building systems are designed, installed, tested and operated to meet the project requirements. Fundamental commissioning is a requirement for LEED certification, but may be done on any project. The commissioning agent should be familiar with different GHP units and GRCO types.

Construction Manager **CM**

The construction manager is typically contracted by NYCDDC or the building owner. They coordinate construction activities between all of the contractors and maintain the overall project schedule. CMs should pay particular attention to any site work and GRCO drilling and installation as well as to GHP system start-up and balancing.

General Contractor **GC**

The general contractor is responsible for overall construction activities, and if there is no **CM**, they will also coordinate and schedule the other trades. The GC will typically perform all earthwork and exterior improvements, which will include excavation and trenching, coordinating drilling and GRCO installation, backfilling, and final site grading.

Drilling Contractor **DC**

The drilling contractor is responsible for drilling and installing loops or wells. The DC may also install and pressure test the horizontal piping runs to the building and connect power to various well pumps. However, on some projects, the mechanical contractor may install the underground horizontal piping while the electrical contractor connects power to pumps.

Mechanical Contractor **MC**

The mechanical contractor performs the indoor mechanical work such as piping and ductwork. The MC will also connect the GHP to the GRCO.

Electrical Contractor **EC**

The electrical contractor performs the indoor electrical work such as installing circuits and powering equipment.

1.5

GHP Project Considerations

Key elements for a successful GHP project execution are:

Investigation of subsurface conditions and appropriate GRCO selection.

Proper sizing of GRCO and GHPs for estimated heating and cooling loads.

Establishing a proper sequence of operation and incorporating controls and monitoring devices such as a Building Management System (BMS).

Establishing clear operation and maintenance procedures.

Ensuring applicable team members are informed of design, construction and scheduling implications of GHP systems during each project phase.

Geotechnical engineers or geologists should inspect and oversee drilling, aquifer pumping tests during construction and well or loop field installation. Critical field conditions and observations should be relayed to design engineers.

Contract documents should contain clear and thorough specifications covering the GRCO, exterior piping system, heat pumps, appurtenant equipment, testing, balancing and commissioning of the entire system. If applicable, integration with the BMS.

The greatest factor in a **GHP** project is the site's subsurface conditions, which creates a level of uncertainty not found in conventional **HVAC** projects. Although available published data, such as maps and reports from the **United States Geological Survey (USGS)**, can provide an overall understanding, site specific information must be confirmed by actual drilling and testing. System design and **GRCO** selection based on insufficient site investigation may develop into larger problems later in the project. However, early research and exploration will allow the design team to address any issues before other project demands limit potential options.

System commissioning and outlining of a long-term operation and maintenance plan are also needed to ensure a properly functioning system. The facility operator will need ample training and contractor support to run and monitor the system through the **BMS**. Depending on budget and project specific needs, hiring a facility manager with expertise in GHP operation is recommended. It may also be advisable for a new GHP system user to enter into a service contract with a geothermal consultant and experienced mechanical and drilling contractors.

1.6

GHP Screening

Despite greater energy efficiency and other benefits, **GHP** systems are not applicable for every project. Project teams considering GHP technology in New York City should review the following issues to determine if these systems are appropriate for their project.

Preliminary Load Analysis

At the start of a project, preliminary heating and cooling loads are generally established based on known or expected occupancy and building construction. Although GHPs can operate in heating or cooling only applications, they are most efficient where these loads are mutually considered for system design. Balanced annual energy loads will help maintain the average ground temperature and maintain thermal efficiency for long-term optimal system operation. Closed loop and **SCW** systems are most efficient when used equally for both heating and cooling.

Some variability in loading is acceptable and can be addressed in the **GRCO** design with greater borehole spacing or depth. If a significant difference in heating and cooling load requirements exist, the design team may consider a hybrid system instead of increasing the GRCO size to meet the larger energy load. Heat exchange with supplemental equipment such as a small boiler or cooling tower reduces the GRCO energy load while continuing to utilize the energy available from the earth. A hybrid system may also be used to better address seasonal imbalances, depending on the actual space conditioning design and equipment.

GHP Screening

Space Assessment and Planning Considerations

GHP systems are ideally suited for new construction and projects with ample open space available. Drilling and installing the **GRCO** with its related piping requires considerable area and must be accessible for drill rigs. Vertical clearance must also be available to accommodate the drill rig mast, which ranges from 30 to 35 feet in height. As a result, GHP systems are not well suited for retrofitting existing structures that cover the entire property, particularly if the heating and cooling load is high.

In addition, each GRCO type requires adequate spacing of wells or boreholes to maintain thermal and hydraulic properties. If sufficient distance is not provided, interference between wells or loops will occur during operation and may cause additional problems. **Table 1.1** compares spacing requirements of each GRCO type for a 100-ton cooling system.

There are options available that may reduce the size of the GRCO as well as drilling costs. A hybrid system would be able to share part of the building load, and reduce the GRCO needed. Although this approach is generally not used, GRCOs may also be installed within the footprint of a new building. However, close coordination between trades during construction is critical and access for future maintenance must be preserved.

Underground Infrastructure

Because New York City's infrastructure is one of the oldest in the country, restrictions and regulations on drilling should be investigated and confirmed early on for **GHP** systems. Structures for city water supply, such as water tunnels, shafts, or appurtenant facilities are regulated by the **New York City Department of Environmental Protection (NYCDEP)**. Project teams should contact NYCDEP to verify if a site is within 500 feet or less of a water supply facility or structure. Approval for drilling is required and requirements on controls and documentation during drilling will vary depending on the distance. Other limitations per NYCDEP regulations may also apply.

Regulations exist for transportation tunnels such as subways, and the relevant agency such as the Metropolitan Transit Authority (**MTA**) should be contacted to confirm any requirements.

Preliminary Cost Estimate

A major portion of **GHP** system costs is from drilling, which is not common in projects with conventional **HVAC** systems. Additional site investigation also increases both the design and construction costs. As a result, there is an initial cost premium that makes GHPs less attractive. However, operating and life-cycle costs are usually much lower than conventional systems. **Table 1.2** compares the approximate costs for each **GRCO** type based on a 100-ton cooling system.

Table 1.1

GRCO Space Requirements

GRCO Type	Heat Transfer Capacity*	Number of Loops or Wells	Spacing Required	Area Required
Closed Loop	2 tons	50 loops	20 LF	21,800 sq ft. (0.5 acre)
Open Loop	1 ton @ 2 gpm †	1 supply well @ 200 gpm, 2 diffusion wells	150 LF to 250 LF, depending on hydrogeologic conditions	30,500 sq ft. (0.7 acre)
Standing Column Well	20 tons	5 wells	50 LF–75 LF	8,700 sq ft. (0.2 acre)

* Based on subsurface conditions in NYC, may differ by location.

† A flow rate of 2 to 3 gpm is required for operation.

1. LF = linear feet of drilled borehole for loop or well

2. ton = measure of cooling capacity, approximately equal to 12,000 Btu/h

3. gpm = gallons per minute

4. Comparison is made based on a total cooling capacity of 100 tons

5. 1 acre is approximately 43,560 ft.

Table 1.2**GRCO Estimated Costs**

GRCO Type	Depth	Heat Transfer Capacity	Number of Wells or Loops	Unit Cost per Installation *	Approximate Cost*
Closed Loop	Loops, 400–500 ft. each	2 tons	50 loops	\$35,000 per loop	\$1,750,000
Open Loop	6" Dia. Wells, 200–300 ft. each	1 ton @ 2 gpm	1 supply well @ 200 gpm/2 diffusion wells	\$125,000 per well	\$375,000
Standing Column Well	Wells, 1,500 ft. depth each	15 tons	7 wells	\$200,000 per well	\$1,400,000

* Costs are approximate even at the time of publication. Actual costs may vary depending on specific project conditions and requirements.

Comparison is made based on a total cooling capacity of 100 tons.

Geothermal Heat Pump System Components



2.0 List of Abbreviations

GHP

Geothermal
Heat Pump

GRCO

Ground Coupling

HDPE

High-Density
Polyethylene

HTF

Heat Transfer Fluid

HVAC

Heating, Ventilation,
and Air Conditioning

HX

Heat Exchanger

SCW

Standing Column Well

2.1 GHP System Components

After preliminary screening and **GHP** systems are still in consideration, project teams can begin a more detailed review of the system. An evaluation of the two main components, the heat pump unit and the **GRCO**, is necessary as distinct options exist for each. Proper understanding of how both components are commonly installed and operated will further contribute to a successful GHP project.

Although GHPs are not overly complex systems, there are key differences from conventional **HVAC** design. Concepts to understand are:

All heat pumps use the refrigerant cycle to transfer heat energy. Unlike conventional air or water-cooled HVAC equipment, GHPs exchange heat with the ground as illustrated in **Figure 2.1 GHP GRCO**.

GHPs require nominal water flows of about 2 to 3 gpm per ton of rated capacity to maintain compressor efficiency. Properly sized GRCO pumps will meet the minimum rate at all times.

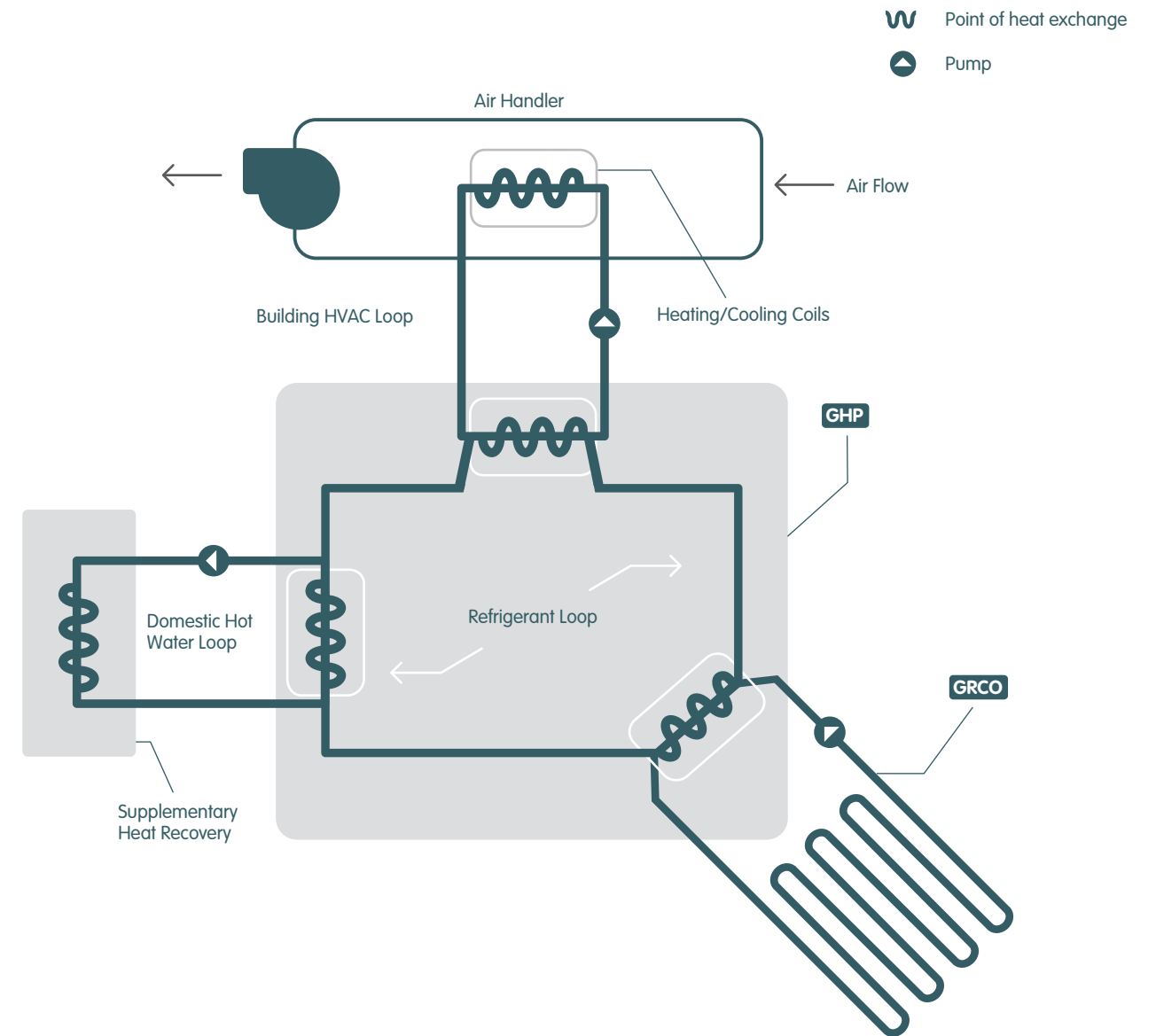
GHPs can supply sufficient heat to a building by virtue of heat transferred and recovered by the refrigerant cycle. Heat pumps can boost the circulating fluid temperature from a low of 20 °F to a high of 120 °F.

Each type of GRCO has an associated thermal capacity. The number of loops in a closed loop system or quantity of standing column wells must meet peak demand.

The thermal capacity of an open loop system is dependent on the pumping rate and ground water temperature. The aquifer beneath a site must therefore be able to supply and accept the required flow rate to meet peak demand.

The operating temperature of the heat transfer fluid is different for each type of system. Open loop systems use ground water that consistently ranges between 55°F to 65°F, while the fluid in closed loop and standing column well systems will have varying temperatures depending on the building operation and demand.

Figure 2.1
GHP System
Heat Exchange Circuits



2.2 Geothermal Heat Pumps

A **GHP** is an adaptation of the standard heat pump, where the ground or ground water serves as the heat sink or heat source. Since ground temperature is cooler than air temperatures in the summer, GHPs can be more efficient than comparable cooling equipment. Similarly, GHPs extract heat from the ground during the winter, and combined with heat recovered from the refrigerant cycle, can provide sufficient heating without additional space heating equipment.

The refrigerant cycle allows heat pumps to provide either cooling or heating by transferring heat energy between the refrigerant and another medium. In cooling mode, the compressor compresses low pressure refrigerant vapor and discharges it at a higher pressure into the condenser. A cooler medium, such as water, travels through the condenser, absorbs heat from the vapor refrigerant and condenses it. The liquid refrigerant at high pressure then flows through the expansion device, which is designed to maintain a specific flow rate while reducing pressure to allow the refrigerant to boil in the evaporator. As the refrigerant evaporates, it extracts the heat from the warmer air passing through it. The reverse process occurs in heating mode.

Because most GHPs are packaged **HVAC** units, they can be quite modular with capacities ranging from ½-ton up to 30-tons commonly used on city and commercial projects. The heat pumps can be distributed throughout the building or centralized at one location. The most common configurations are water-to-air and water-to-water as shown in **Figure 2.2**.

Water-to-Air

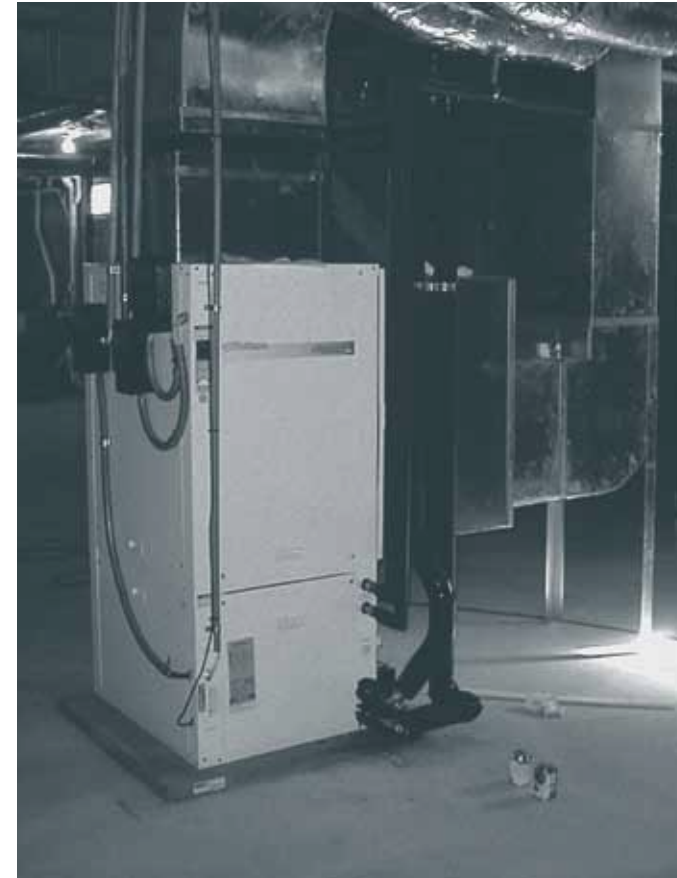
These units are typically used to directly heat and cool the building spaces they serve. **Figure 2.3.1** and **Figure 2.3.2** shows flow diagrams for a water-to-air GHP in the cooling and heating modes.

Water-to-Water

These units are typically used to indirectly heat and cool building spaces by producing chilled water for cooling or hot water for heating. The heating or cooling of building spaces is provided by auxiliary HVAC equipment serving individual locations such as radiators, fan coil units, or air handlers **Figure 2.4.1** and **Figure 2.4.2** shows flow diagrams for a water-to-water GHP in the cooling and heating modes.

A common concern regarding GHPs is whether they can provide enough heat to meet building heating loads. However, the refrigerant cycle produces waste heat that can be recovered and used to increase the heating capacity of these systems. The heat recovery process enables heat pumps to raise the temperature of the circulating fluid, typically from 55 to 65 °F, to as high as 120 °F. Even temperatures as low as 20 °F commonly found in closed loop systems can be raised sufficiently for heating purposes.

Figure 2.2
Common GHP Units



Water-to-Air

Air is supplied to the unit, conditioned, and ducted to spaces directly



Water-to-Water

Water is circulated through the unit, chilled or heated as needed, and piped to terminal units for space conditioning

Figure 2.3.1

Water-to-Air Flow: Cooling Cycle

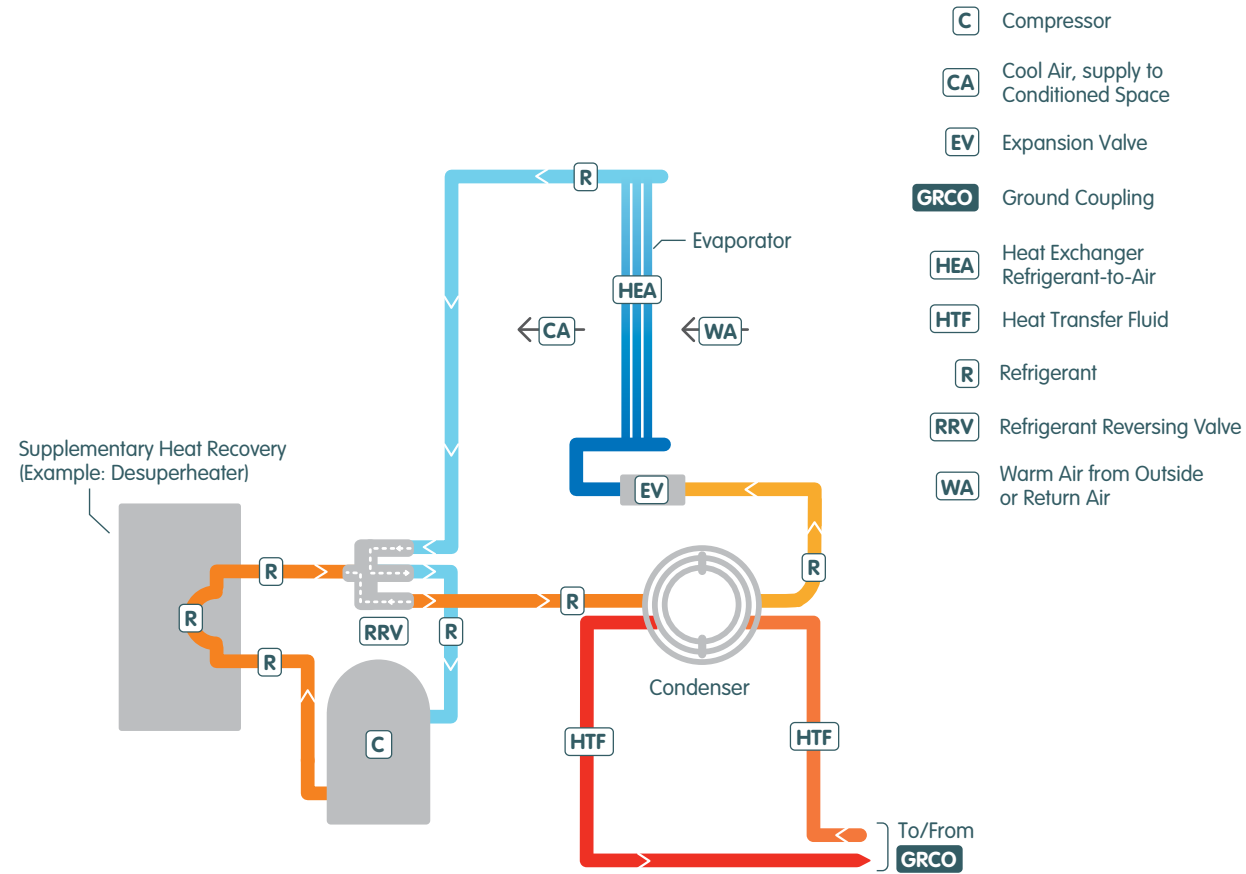


Figure 2.3.2

Water-to-Air Flow: Heating Cycle

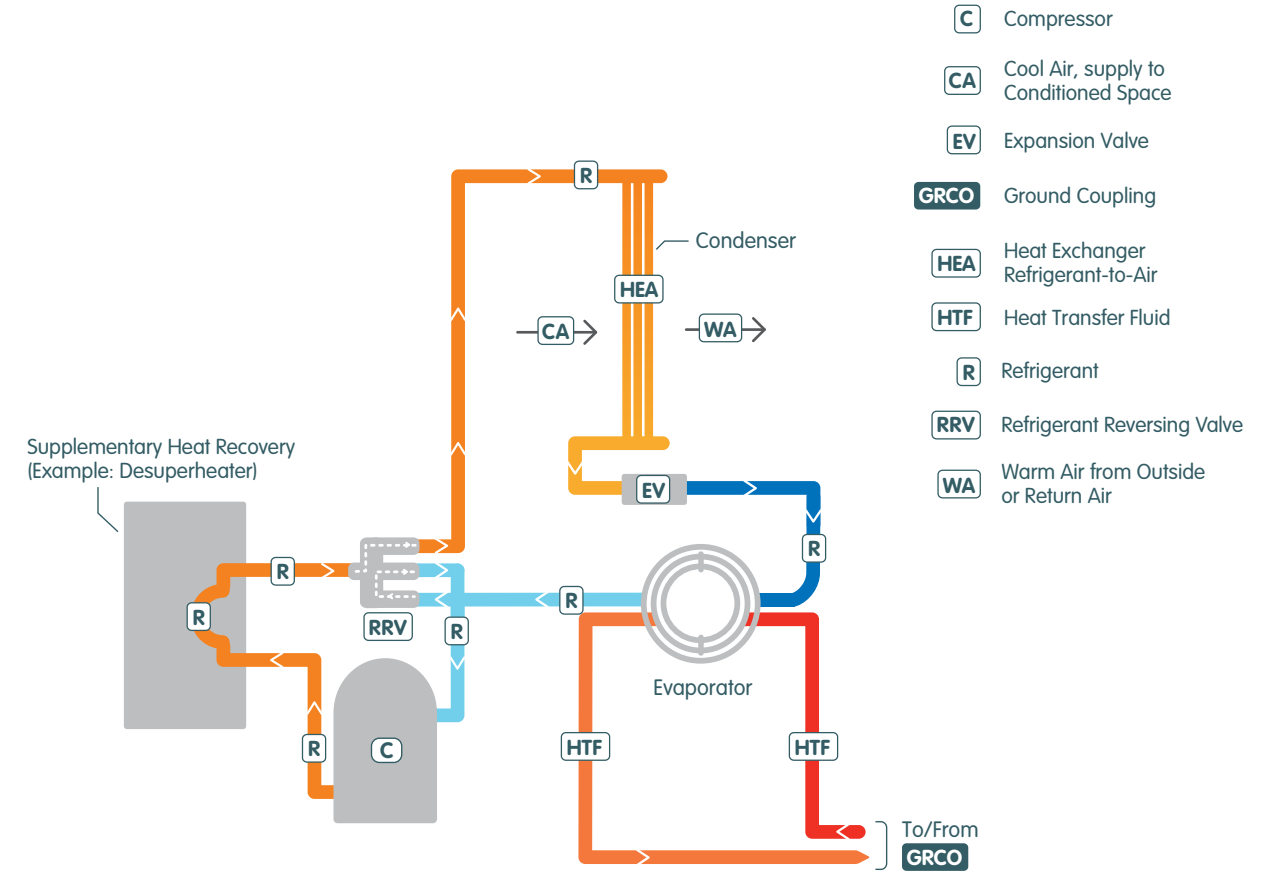


Figure 2.4.1

Water-to-Water Flow: Cooling Cycle

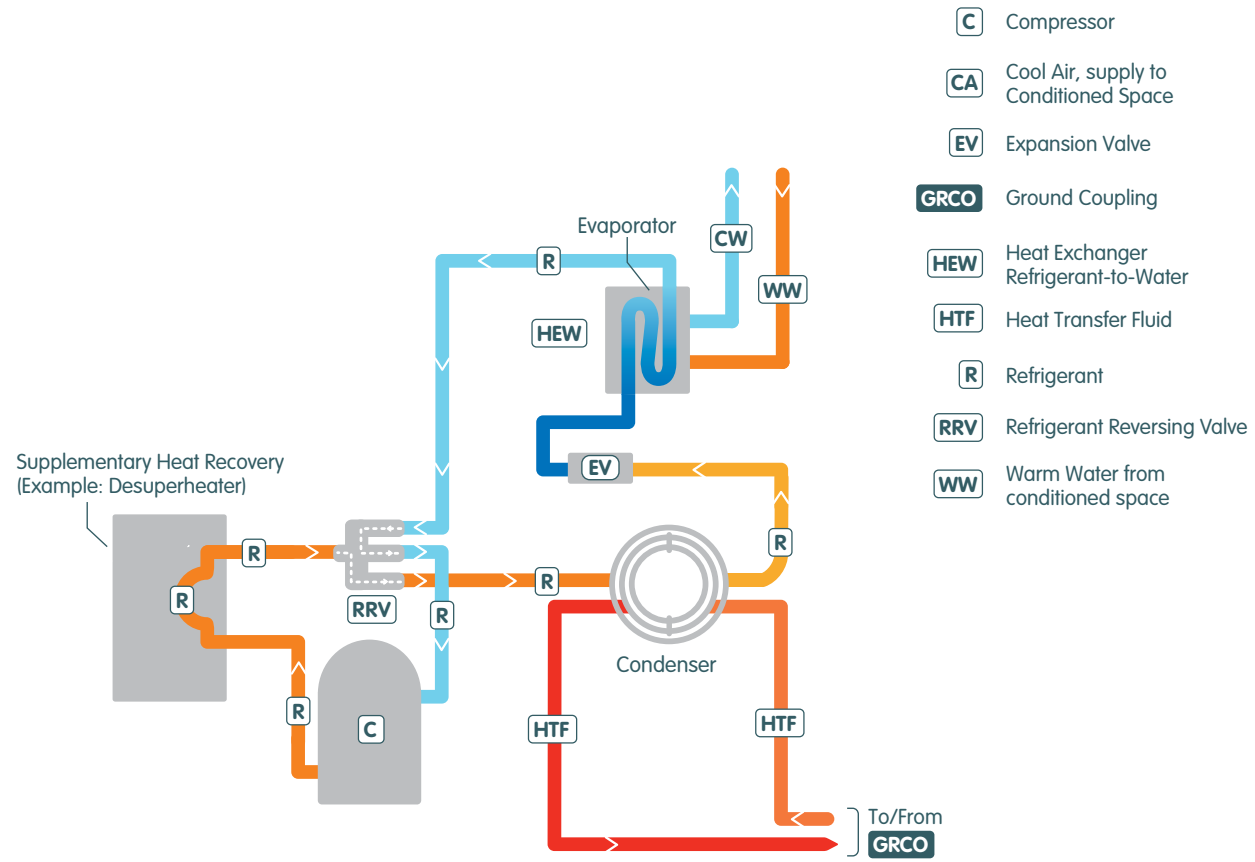
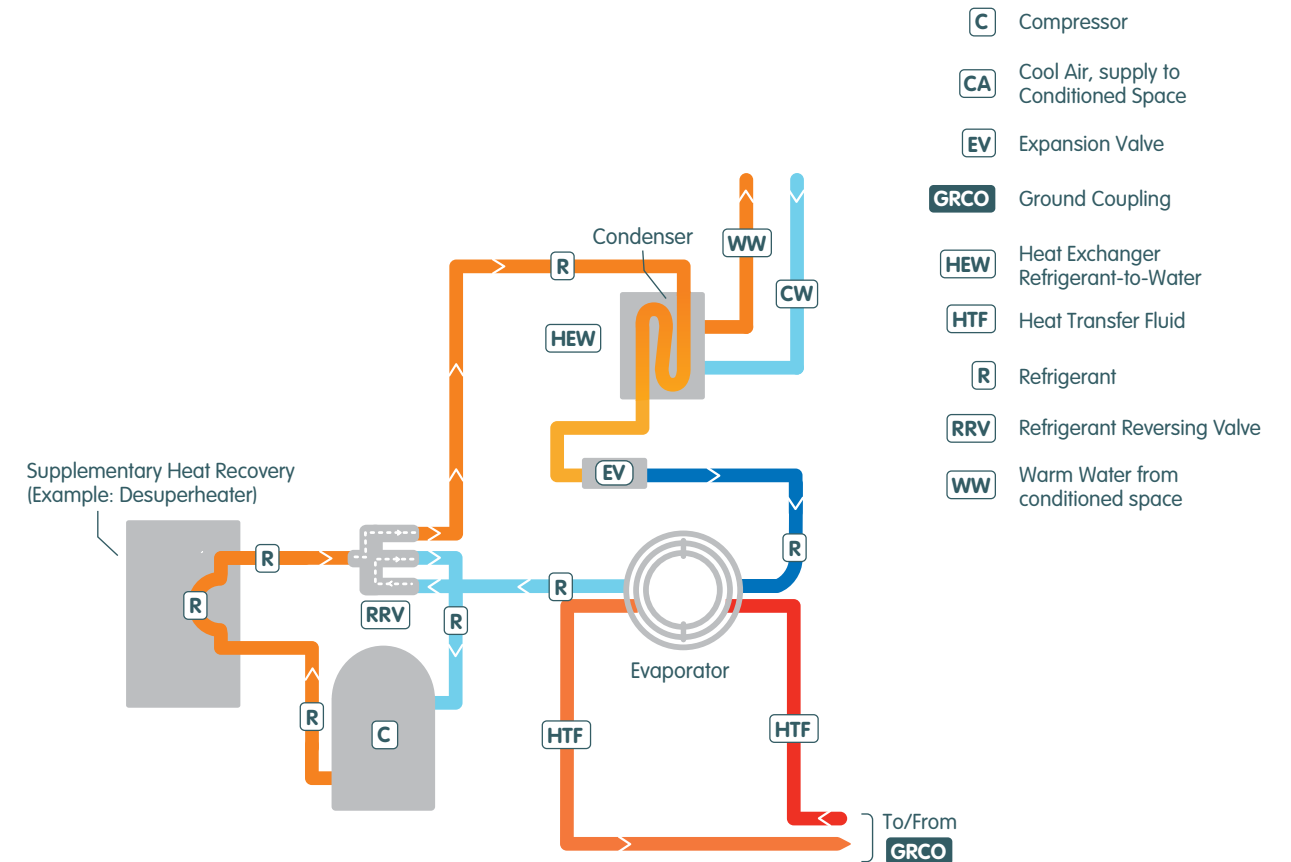


Figure 2.4.2

Water-to-Water Flow: Heating Cycle



2.3 Ground Couplings

A **GHP** uses the **GRCO** to transfer heat energy to and from the ground. Although various system options are available, the three main types of GRCOs used in New York City are closed loop, open loop and standing column wells. Systems will vary by depth, spacing, and heat transfer fluid **HTF**, as summarized in **Table 2.1**.

Thermal Capacity

A key consideration for GRCOs is thermal capacity, which is used in selecting and designing an appropriate system. Factors influencing capacity include the loop or well depth, conductivity and thermal diffusivity of the surrounding geologic materials, heat transfer fluid flow rate, and difference in temperature between the fluid and the ground. **Table 2.2** compares the thermal capacities found in typical GRCO installations. Capacities provided are generalized for the city and are only rough estimates for system sizing.

Generally, closed loop systems tend to have the least capacity and often require more area to install more loops. In contrast, open loop systems have much higher capacity because of direct ground water use. Standing column wells also offer more capacity than closed loop but through much deeper drilling depths.

Table 2.1
Typical Configurations

System Type	Typical Depth	Spacing	Heat Transfer Fluid
Closed Loop	200–500 ft.	20 ft. between loops	Water or water and non-toxic antifreeze mix
Open Loop	150–300 ft., depending on aquifer hydraulics	150–250 ft. between supply and diffusion wells	Ground water
Standing Column Well	1,500–1,800 ft.	50–75 ft. between wells	Ground water



1. ft.=Feet

Table 2.2
Estimated Thermal Capacities

System Type	Typical Installation	Thermal Capacity Range for Typical Installation	Unit Thermal Capacity
Closed Loop	500 LF	2.5–3.3 tons (30 to 40 MBH)	150–200 LF
Open Loop	300 gpm, total flow rate	100–200 tons (1,200–2,400 MBH)	1.5–3.0 gpm
Standing Column Well	1,500 LF	15–43 tons (180–500 MBH)	35–100 LF



1. LF = Linear Feet

2. ton = measure of cooling capacity, approximately 12,00 Btu/h

3. MBH = measure of heating capacity, equal to 1,000 Btu/h

4. gpm = gallons per minute

5. For open loop systems, heat transfer is dependent on ground water flow rate and the temperature differential between supply and discharged water. Thermal capacity is therefore not directly related to well depth and cannot be generalized for rough system sizing.

Source Temperature

Source Temperature

One frequent misconception is that **GHP** systems have consistent source temperatures because of stable ground temperatures. However, each **GRCO** system has a daily and seasonal temperature range, which varies significantly between the three types. Expected temperature ranges by system are summarized in **Table 2.3**.

Open loop systems have relatively constant source temperatures compared to other GRCOs as ground water is pumped and returned to the same aquifer. The returned water, which may be warmer or cooler depending on GHP operation, is recharged and blends with the ambient ground water. Provided that there is sufficient spacing between the supply and diffusion wells, ground water temperatures remain consistently stable.

Temperatures for closed loop and standing column well are seasonally influenced because the same **HTF** is recirculated. At the beginning of summer or winter, the HTF temperature may be close to the ground temperature. However, its temperature will generally increase over the summer and decrease over the winter as more heat energy is rejected to or extracted from the ground. The extended temperature ranges of GHPs can compensate for this variation, but compressors will work harder during peak demand and in the latter part of each season.

Table 2.3

Temperature Ranges for Heat Transfer Fluid

System Type	Heat Transfer Fluid	Summer Operation Temperature Range	Winter Operation Temperature Range	Remarks
Closed Loop	Water or water and non-toxic antifreeze	70–90 °F	30–40 °F	ΔT between supply and return water is 5–10 °F. Peak summer temperatures can reach 90–100 °F. Peak winter temperatures can drop below 30 °F with use of antifreeze.
Open Loop	Ground water	55–65 °F from supply well, 65–85 °F to diffusion wells	55–65 °F from supply well, 35–45 °F to diffusion wells	Consistent supply well ground water temperature; return temperature to diffusion wells depends on ΔT preference of designer.
Standing Column Well	Ground water	65–80 °F	35–50 °F	ΔT between supply and return water is 3–6 °F. Peak summer temperatures can reach 80–90 °F. During winter, care should be taken to prevent heat pump or wells from freezing. Well bleed cycle is recommended to control supply water temperature during peak cooling and heating load operation.

1. Subsurface temperatures in NYC range from 55 to 65 °F.

2. ΔT = Delta T, or difference in temperature

Closed Loop System

Closed Loop System

A closed loop system is completely sealed and separated from the surrounding environment. Although horizontal configurations installed in trenches are common, they require large, open areas that are not generally available in the City. Instead, the vertical configuration with a grid of interconnected high-density polyethylene **HDPE** plastic piping loops installed in drilled vertical boreholes makes better use of limited space as illustrated in **Figure 2.5**.

The piping system is filled with either potable water or water mixed with a non-toxic, biodegradable anti-freeze such as food-grade propylene glycol. Pumps located inside the building's mechanical room circulate the fluid at a nominal flow rate of 2–3 gpm per ton of installed heat pump capacity. Heat exchange occurs through conduction between the **HTF** circulating in the loop and the ground with no direct contact. Field testing is essential for proper sizing and design of a closed loop system, and involves drilling a borehole, installing a loop, and conducting a thermal conductivity test.

Figure 2.5
Typical Closed Loop System

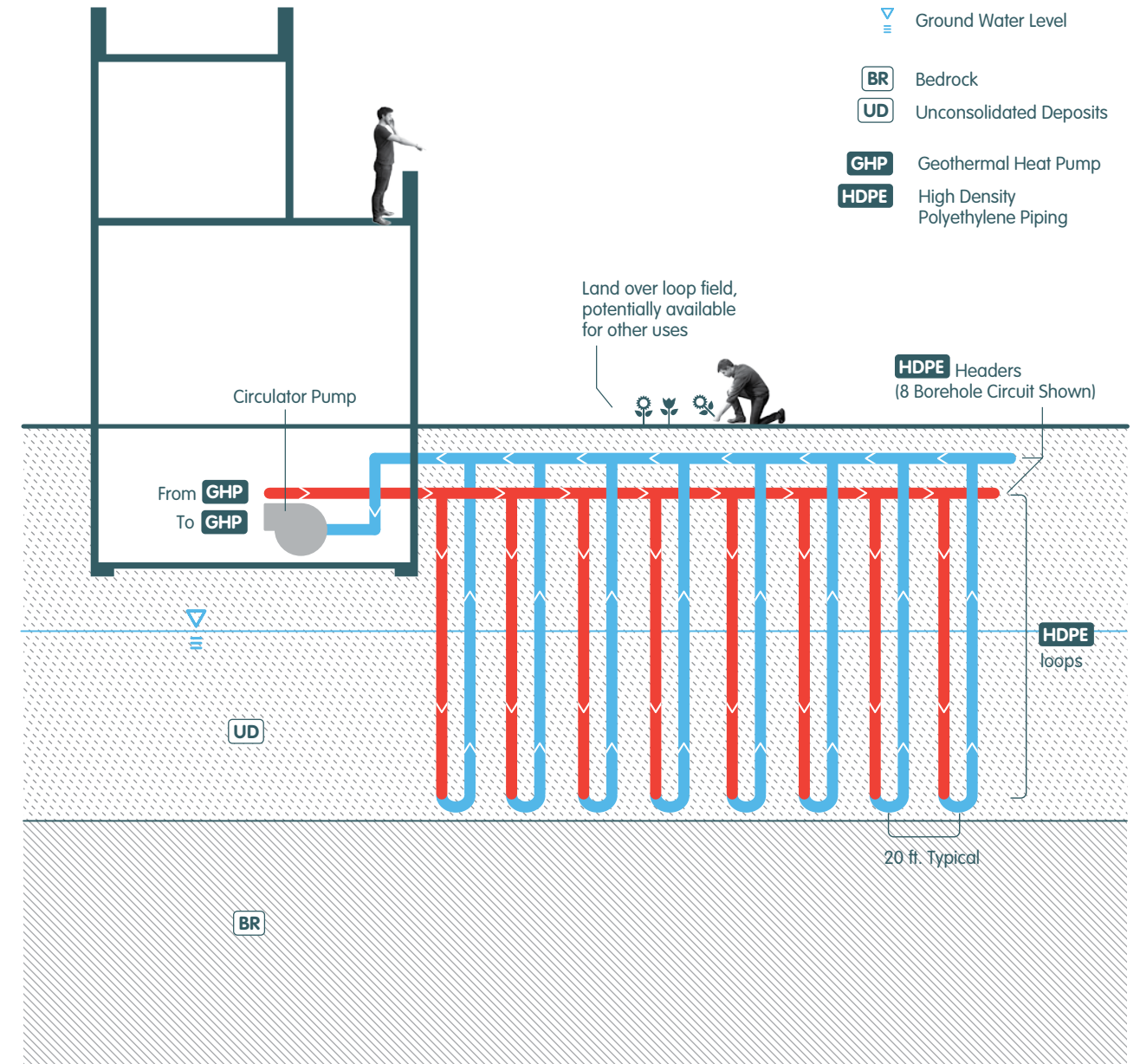


Figure shown in cooling mode.

Closed Loop System

Figure 2.6 illustrates an individual loop and borehole construction. Boreholes are drilled as deep as 500 feet at an optimal diameter of 5 to 6 inches. Each loop consists of two, 1 to 1.25 inch diameter pipes that are connected at the bottom with an 180-degree “U-bend” fitting. The loop assembly is lowered to the bottom, and pressure tested as shown in **Figure 2.7**. If no leaks are detected, then a thermally-enhanced grout is pumped into the borehole. The grout, which is a mixture of clay, water and sand, fills the annular space between the loop piping and borehole wall. **Figure 2.8** shows grouting in progress with the grout being delivered through a separate pipe to the bottom of the borehole first. When grout is seen at the top of the borehole, pumping is terminated. Once the grout solidifies, it seals the loop in place, preventing vertical flow of ground water, and enables good conduction with the surrounding environment.

The radius of thermal influence around a loop is approximately 10 to 15 feet. Therefore, loops are typically spaced approximately 20 feet apart, allowing for some overlap. Horizontal **HDPE** piping connects the loops together to create circuits, typically four to ten loops per circuit. The circuit piping is routed to a manifold either inside the building or an outside vault. Larger diameter main headers connect the manifold to GHPs. All exterior horizontal piping is installed in trenches below the frost line and then backfilled.

Thermal capacity of a vertical closed loop system is dependent on depth, thermal conductivity and diffusivity of the subsurface materials, grout surrounding the loop flow rate, and difference in temperature between the **HTF** and the ground. For estimating purposes, 150 to 200 linear feet of loop is typically needed for one ton of thermal capacity. Therefore, 500 feet of installed loop will provide approximately 2.5 to 3.3 tons, or 30 to 40 MBH, of capacity.

Figure 2.6
Closed Loop Construction

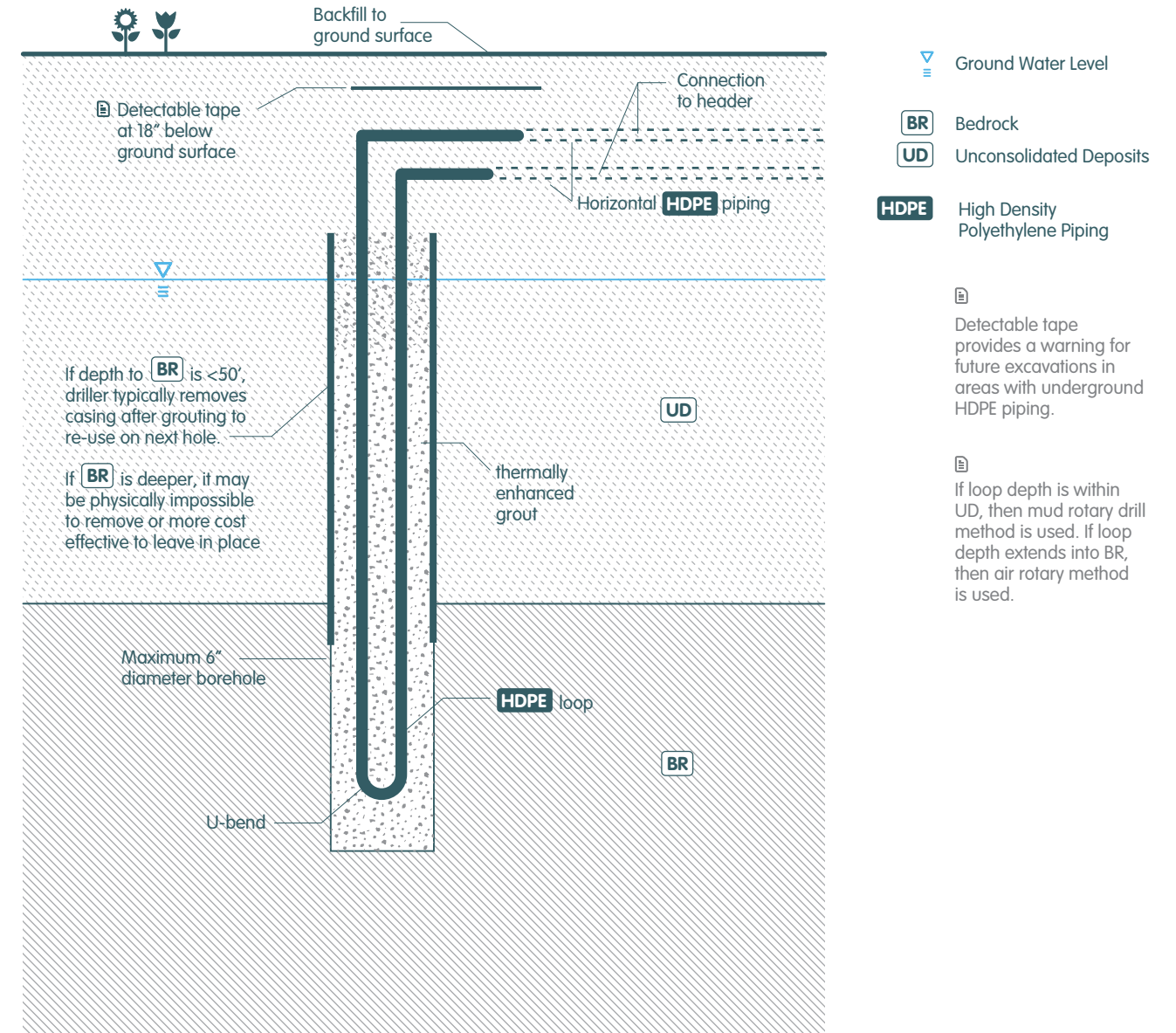


Figure 2.7

Pressure Testing of Loop



Figure 2.8

Loop Installation



Open Loop System

An open loop system uses ground water for heat exchange by extracting and returning water through supply and diffusion wells installed in permeable aquifers.

Figure 2.9 illustrates the basic system layout where a down-hole submersible pump delivers ground water at ambient temperature. Although some **GHP** have an integrated heat exchanger, a separate plate-frame heat exchanger **HX** is an optional device that may be beneficial when ground water is directly used. It maintains a physical separation between ground water and the GHP unit, which limits the exposure of contaminants to mechanical equipment.

Ground water passes through the system once before returning to the aquifer through diffusion wells. Two diffusion wells are generally recommended for each supply well because returning water to the aquifer is more difficult than extracting it. However, the only difference between the supply and returned water is temperature as heat is exchanged.

Wells consist of two main components, a solid metal casing and a stainless steel well screen at the lower portion of the borehole. **Figure 2.10** shows a well screen segment during installation. Openings in the screen filter particles from the entering ground water and allow returning water to be re-injected to the aquifer.

Open loop systems require a highly permeable aquifer such as sand and gravel deposits. Aquifers containing a lot of clay and silt can restrict the flow of ground water and should be avoided. Additionally, the aquifer must be able to supply and accept a consistent 1.5 to 3 gpm per ton of capacity. Hydrogeological studies of a particular area from a reliable source such as the **USGS** are essential in evaluating the viability of an aquifer. Regardless, an aquifer pumping test is necessary for confirming site specific hydraulic properties and is conducted using one or more test wells. Open loop systems are one of the more common systems used in Brooklyn and Queens because of the highly productive aquifers in the boroughs.

A key consideration in open loop system design is well placement. As ground water is pumped from the aquifer, the water level surrounding a supply well is drawn down, similar to an inverted cone. When water is returned, there is usually a mounding effect around each of the diffusion wells. Although a minimum of 150 to 250 linear feet between supply and diffusion wells is recommended to avoid potential overlap in areas of influence, actual spacing will be determined by the aquifer's hydraulic properties, specified flow rates, pumping schedule, and annual pump run times.

Figure 2.9
Open Loop Well System

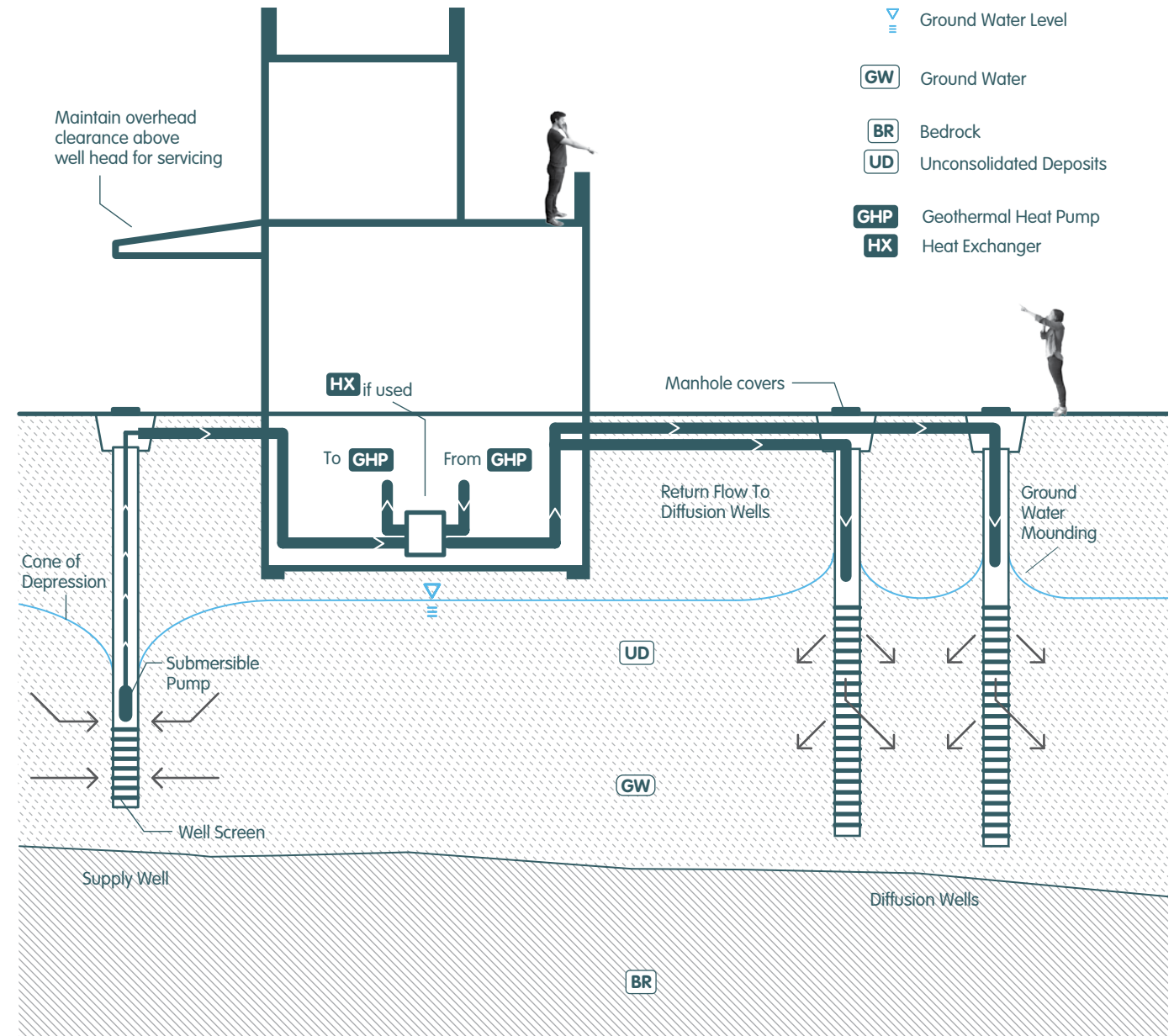


Figure 2.10

Well Screen Installation and Detail



Open Loop System

Supply and diffusion wells with inadequate spacing may cause thermal breakthrough, where water returning to the aquifer may alter ground water temperatures on the supply side. Additionally, supply wells should be located upgradient of diffusion wells, allowing natural ground water movement to direct discharged water away from the supply area and further reduce potential thermal effects. Anticipated pumping rates can also affect well spacing as a lower rate will result in a higher temperature differential between the supply and return side. A higher temperature differential will require greater separation between supply and diffusion wells to reduce the risk of thermal breakthrough.

If multiple supply wells are required to operate simultaneously, they should be sufficiently separated to limit the combined drawdown effects on each other known as well interference. Similarly, multiple diffusion wells should be properly spaced to avoid ground water mounding in the area, particularly at project sites where the depth to water is shallow. Excessive mounding may create higher backpressures on system pumps, which can lower pumping rates, increase the temperature differential and reduce overall efficiency.

At relatively small sites with moderate to high building loads, adequate spacing may not always be available. Some hydraulic and thermal influence is generally acceptable without seriously compromising system operation, but should be verified through hydraulic testing or computer modeling. Supply and diffusion well screens can also be separated vertically to help avoid overlap, but both must be installed within the same aquifer per New York State regulatory requirements.

Ground water quality is another critical factor for open loop design. Ground water analysis is recommended during the schematic design phase to determine chemical compound levels that can affect system operation and to evaluate measures to address poor water quality. Urban ground water contains dissolved metals such as iron, organic pollutants, high salinity, and bacteria. These compounds can lead to scaling, biofouling or corrosion of metallic piping, valves and mechanical equipment. Biofouling is the proliferation of iron-related bacteria and their byproducts in the presence of high iron and organic matter in a well. Excessive biofouling and scaling can lead to loss of system efficiency by clogging diffusion well screens. High maintenance costs and even complete system failure are possible if water quality is not addressed in design.

Open Loop System

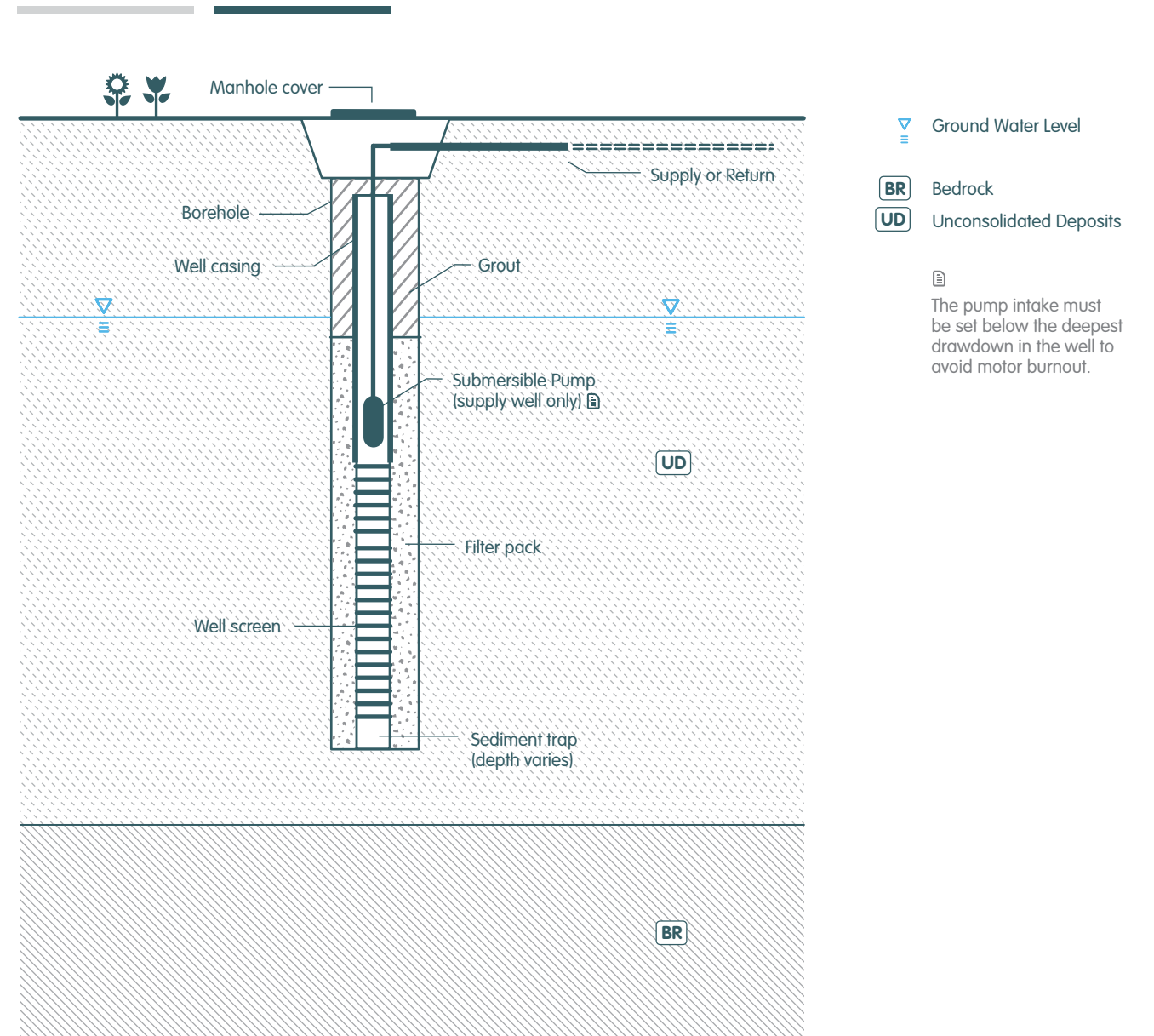
Well screens must be designed to minimize the amount of particulates such as sand, silt, and clay that can enter the well from the aquifer. A high particulate load in the diffusion well can clog screen slots, reduce flow rates back to the aquifer, and cause excessive backpressure and submersible pump damage. Slot sizes should also be designed to better match the different aquifer conditions throughout the depth of the well.

After the well screen is installed, a filter pack is placed between the screen and the borehole, which stabilizes the borehole against the screen. It also serves to improve thermal conductivity by increasing the well's effective hydraulic diameter. Filter pack materials should have the appropriate porosity to allow proper ground water flow and limit excessive sedimentation. Uniformly sized sand is typically used. [Figure 2.11](#) illustrates the typical well construction for an open loop system.

Whenever possible during well drilling, the use of bentonite as a drilling fluid should be avoided to prevent any residual adherence to the well screen and the surrounding filter pack. Using water as the primary drilling fluid is recommended in areas where borehole collapse is minimal. Drillers should also disinfect all down-hole equipment to ensure that there is no cross-contamination of bacteria from equipment to the well.

The thermal capacity of an open loop system is dependent on the temperature difference between the ground water on the source side and the building circulation loop on the load side. This difference is known as the approach temperature, or ΔT . The **GHP** system designer determines ΔT , which typically varies from 10 °F for a thermal capacity of 3 gpm per ton to 25 °F for 1.2 gpm per ton. Therefore, the thermal capacity of an open loop system at a pumping rate of 300 gpm for typical aquifers in Brooklyn and Queens would range from 100 tons to 250 tons with a ΔT between 10 and 25 °F.

Figure 2.11
Open Loop Well Construction



Standing Column Well System

A standing column well **SCW** is a variation on an open loop system that combines the supply and diffusion process in the same well. As with an open loop system, ground water is the **HTF**. However, a SCW is much deeper than an open loop well and is installed in bedrock rather than unconsolidated aquifers. A typical SCW is approximately 1,500 feet deep, but some have been drilled to as deep as 1,800 feet in the city. **Figure 2.12** illustrates a conventional standing column well system.

The surface casing for a SCW is required to extend a minimum of 75 feet into competent bedrock per **New York State Department of Environmental Conservation NYSDEC** regulations. Below this depth, the well is a self-supporting, uncased open borehole. **Figure 2.13** illustrates the typical standing column well construction and indicates the placement of the surface casing within the borehole.

Ground water from the bedrock aquifer will naturally fill the borehole and seek its own level. A central pipe called a Porter Shroud, is inserted into the borehole, which is smaller than the well diameter, and extends the entire length of the well. Perforations at the bottom allow ground water to enter, while a submersible

pump set below the water table within the well pumps ground water to the building. **Figure 2.14** shows the approximate size of a typical submersible pump. The return pipe is also located at the top of the well, but outside of the shroud. As returned water flows down the annulus, it exchanges heat with the surrounding bedrock. The process is repeated when the ground water is drawn into the intake again. Unlike open loop wells, a SCW system does not rely on large amounts of ground water, although determining water quality is important to protect both the submersible pump and the **GHP**.

Typical spacing between multiple wells should be at least 50 to 75 feet. Similar to the other **GRCO**, some overlap in the areas of thermal influence is allowable. Again, closer spacing may affect the performance of the system. Computer modeling and appropriate calculations should be used to verify if this type of system is still viable for the project.

Figure 2.12
Standing Column Well System

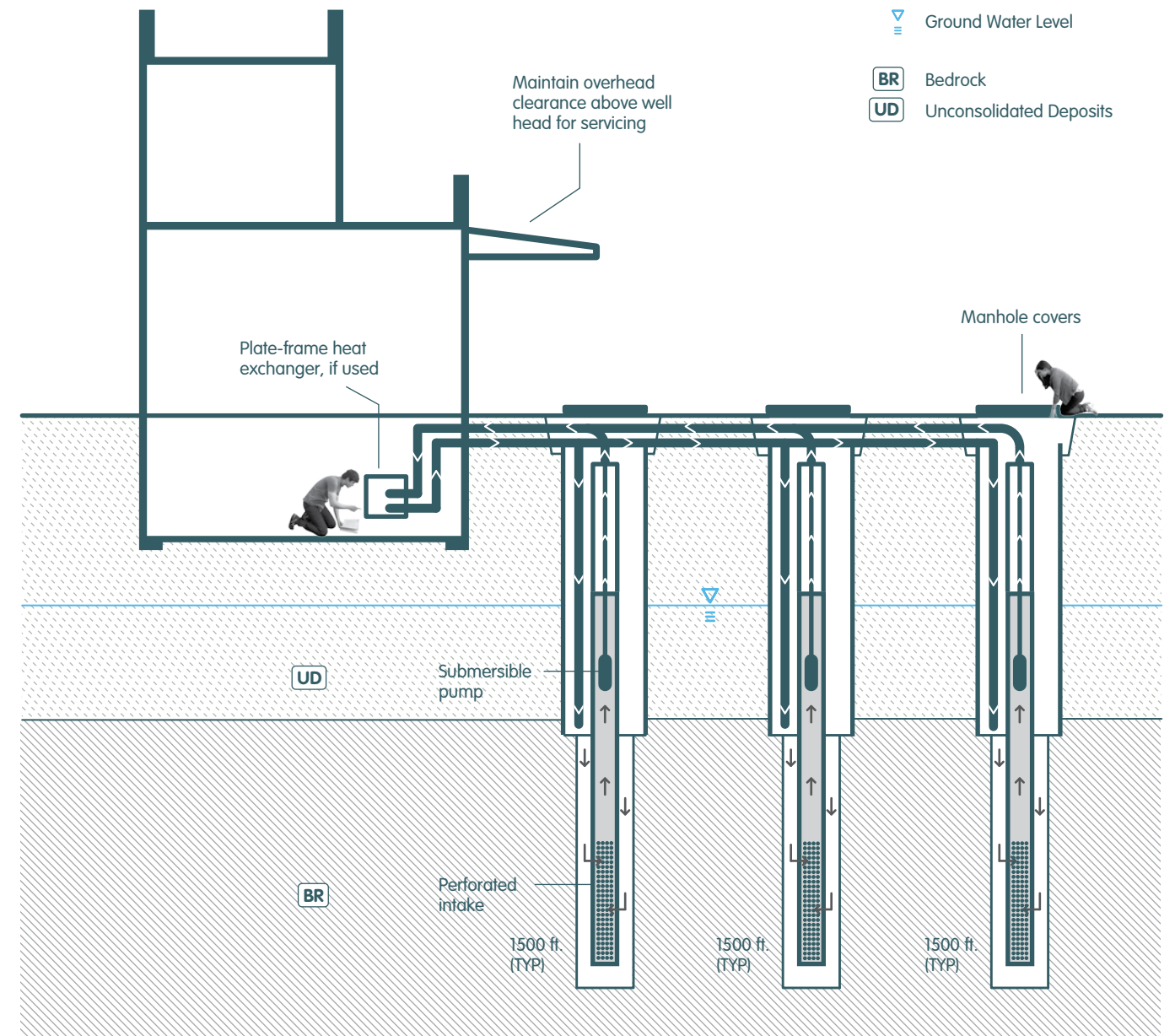
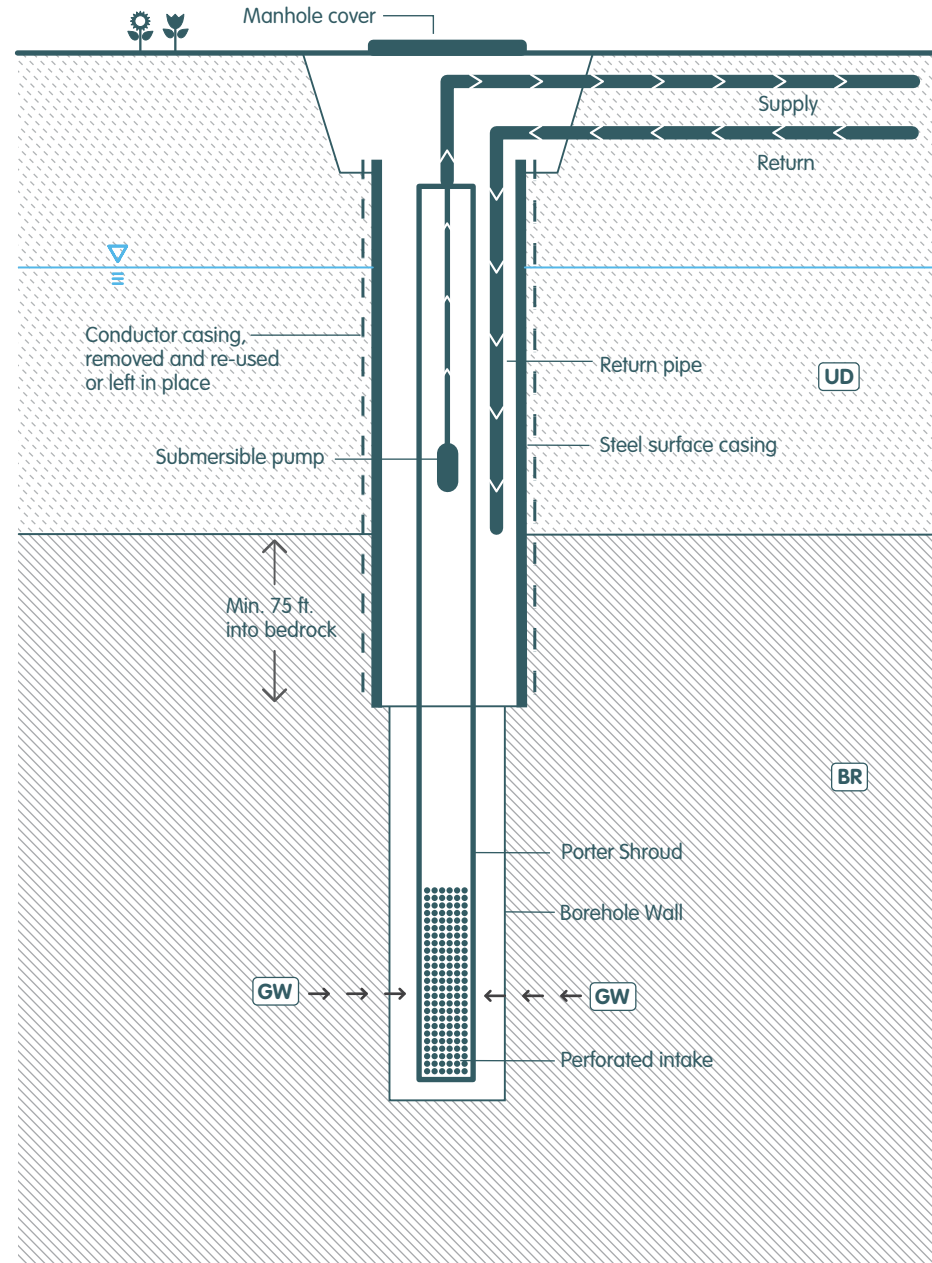


Figure 2.13

Standing Column Well Construction



-  Ground Water Level
-  Ground Water
-  Bedrock
-  Unconsolidated Deposits

Figure 2.14

Submersible Pump



Standing Column Well System

Bleed is a common practice used to optimize **SCW** performance and the ability to bleed may reduce the total well depth. By diverting a small percentage of return water from the well, bleed draws in fresh ground water from deeper bedrock fractures to moderate well water temperature, as illustrated in **Figure 2.15**. During peak cooling, high well water temperatures decrease heat pump efficiency, and bleed is necessary to restore more efficient source temperatures. During peak heating, temperatures approach freezing conditions, and bleeding brings in warmer ground water to prevent a significant temperature drop.

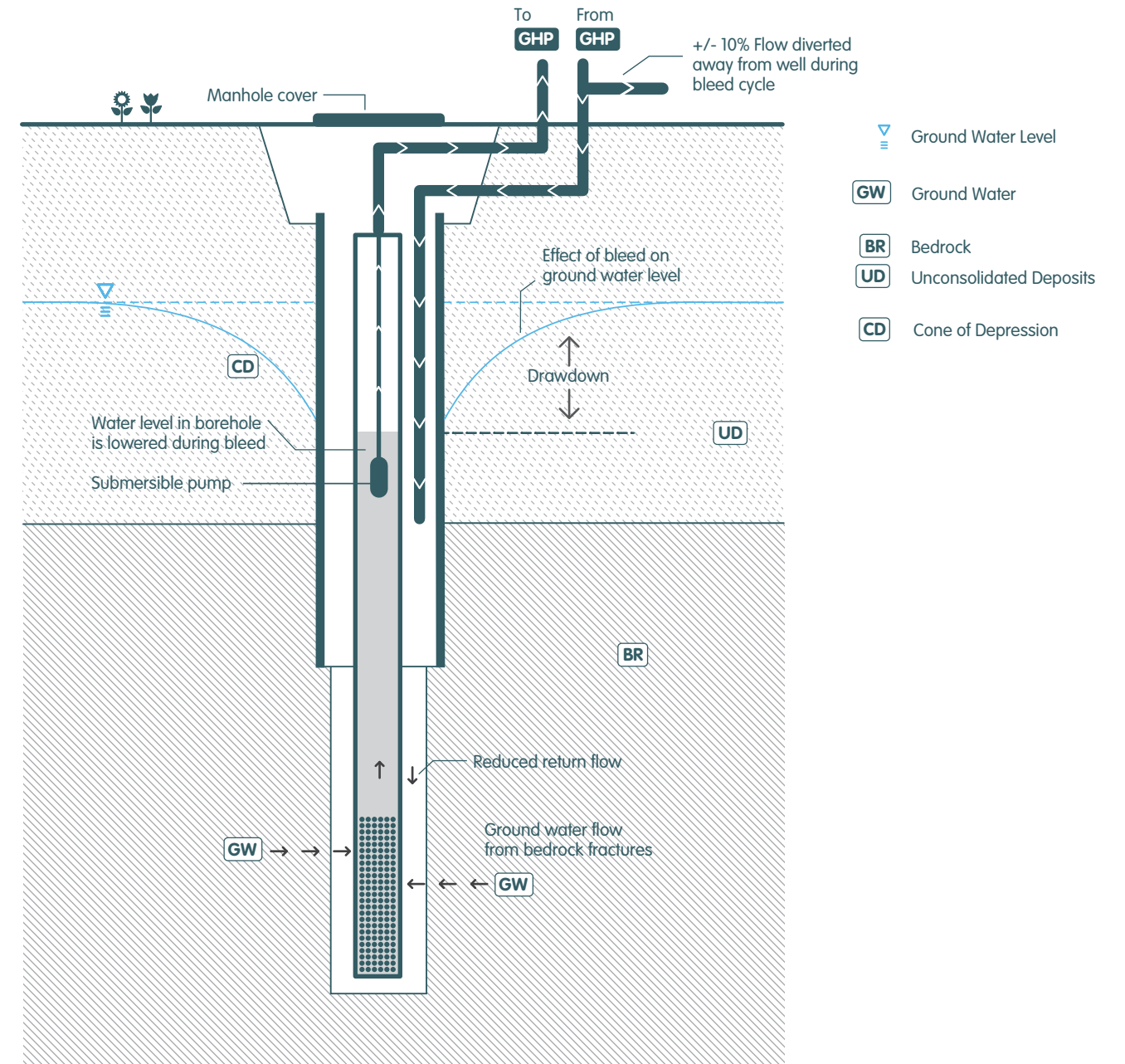
Once supply water temperatures return to the design range, bleed is reduced or terminated. Bleed durations typically should not last for more than a few hours during peak energy demand. The designer should be aware that the combined drawdown effect of multiple wells being bled is significantly greater than a single well. The drawdown effect may potentially extend beyond the property line into adjacent properties. Prolonged or routine bleeding during normal load conditions should be avoided or ground water levels may be permanently lowered. The result would be greater energy required for pumping and adverse effects on other wells.

Based on computer modeling and empirical data, the optimal bleed rate is about 10% of the total flow through the well. For example, if ground water is circulated at approximately 100 gpm, the optimum bleed rate would be roughly 10 gpm. Bleed is possible only for wells that intersect water-bearing fractures. Well yield should be continuous and greater than the design bleed rate so that drawdown is minimized.

The thermal capacity of a SCW is dependent on well depth, conductivity and diffusivity of the bedrock formation in addition to ground water flow rate, bleed rate, and temperature difference between circulating ground water and the surrounding bedrock. With a range of 35 to 100 linear feet of well depth per ton, a 1,500 feet deep SCW can provide between 15 to 43 tons, or 180 to 504 MBH, of capacity. The higher capacity of 43 tons occurs where bleed is optimized. The lower capacity of 15 tons occurs in wells that yield limited ground water, and thus cannot be reliably bled. However, field experience has shown that individual 1,500 feet deepwells under non-bleed conditions have provided approximately 15 to 20 tons of capacity in the city.

In addition, the thermal capacity of a SCW is higher for boreholes that intersect water-bearing fractures, faults or joints in bedrock. These conditions allow ground water to flow more easily into the well, recharging the water column with lower temperature ground water.

Figure 2.15
Illustration of Standing Column Well Bleed





3.0 List of Abbreviations

DTB

Depth to Bedrock

DTW

Depth to
Ground Water

GHP

Geothermal
Heat Pump

GRCO

Ground Coupling

HDPE

High-Density
Polyethylene

HVAC

Heating, Ventilation,
and Air Conditioning

SCW

Standing Column Well

3.1 Schematic Design

During the schematic design phase, a design team evaluates different options to address a project's needs, goals and constraints. When a **GHP** system is being considered, an additional layer of analysis is necessary to ensure appropriate system selection and proper execution. Because preliminary screening is a broad assessment of project conditions, site investigations and careful system evaluation should be completed before further design.

Along with site properties such as geologic and hydrogeologic conditions, project specific issues such as construction schedule and required maintenance may dictate system design. The design team must communicate with the building owner and operator to avoid any potential conflicts. Issues that are not resolved early on may lead to larger and more expensive problems in the future. At minimum, the entire project team will need to evaluate the following prior to selecting and designing a GHP system:

- Installation costs
- Filings and permit requirements
- Project schedule
- System reliability
- Operation and maintenance
- Architectural impact
- Construction impact on neighbors

3.2 Geology and Hydrogeology

New York City's geology is quite complex and varies across the five boroughs, presenting an interesting challenge for implementing **GHP** systems. Understanding how these systems interact with the ground is essential for proper design and requires a brief overview of geology and hydrogeology. Geologic formations identified in the City range from Precambrian bedrock 1.2 billion years old to modern unconsolidated deposits less than 12,000 years old. In addition, the presence of ground water aquifers and their chemical characteristics fluctuate considerably, even between adjacent properties. Therefore, a site's distinct hydrogeologic profile is a major factor in determining which systems are suitable and guide the ultimate **GRCO** selection.

General

In most areas, the City is essentially characterized by a layer of unconsolidated glacial deposits overlying various types of crystalline bedrock. Variations exist in their origin, distribution, thickness, and hydraulic properties. Unconsolidated deposits are composed of sand, silt, clay, gravel, or mixtures thereof. They generally contain ground water and can readily yield large, sustainable amounts from properly constructed wells.

In contrast, bedrock is a consolidated, crystalline material that typically provides low yields unless highly fractured. It is present everywhere, however, varies in depth throughout the five boroughs. Notable areas where bedrock is found at the surface include Central Park in Manhattan. Bedrock is largely overlain by significantly younger unconsolidated deposits, where present.

Figure 3.1 is an illustrated hydrogeologic cross-section through Brooklyn and Queens and delineates the unconsolidated deposits that form the hydrogeologic system. Bedrock is closest to the surface along the East River at a peak elevation of +15 feet above mean sea level and drops off steeply to -1,100 feet at the Rockaways by the Atlantic Ocean, an approximate slope of 80 feet per mile. As the bedrock depth deepens, the overlying deposits thicken and form distinct hydrogeologic units.

Manhattan and Bronx are defined by bedrock at or close to the surface with thin layers of overlying deposits in most areas. Central and western areas of Staten Island have a similar distribution as Manhattan and Bronx while the eastern and southern portions of the island are mostly unconsolidated, similar to Brooklyn and Queens.

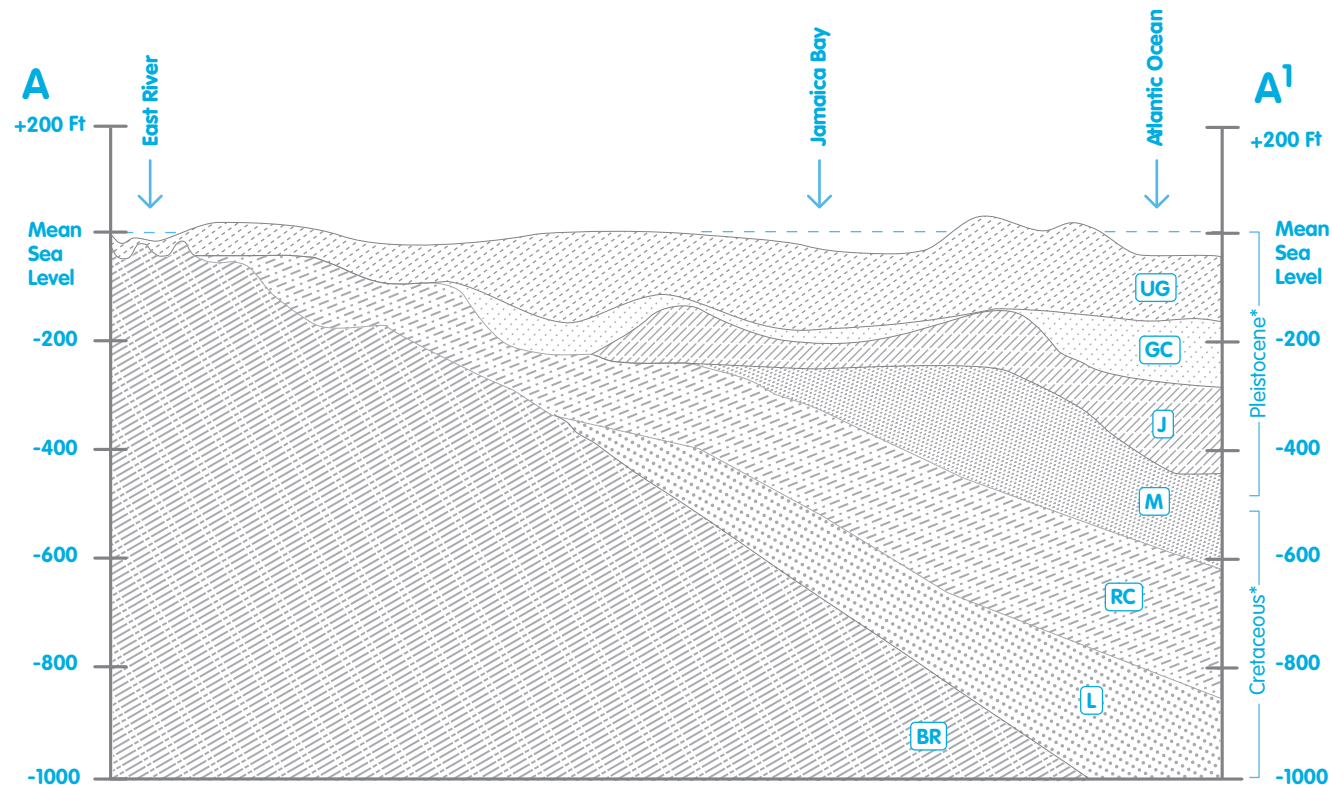
Figure 3.1

Hydrogeologic Cross-Section of Brooklyn and Queens



* Section A above refers to Cross section below

- | | |
|---------------------------------|------------------------|
| UG Upper Glacial aquifer | RC Raritan clay |
| GC Gardiners clay | L Lloyd aquifer |
| J Jameco aquifer | BR Bedrock |
| M Magothy aquifer | |



* Pleistocene and Cretaceous refer to the geologic age of the overlying deposits.

Geology and Hydrogeology

Unconsolidated Deposits

The **USGS** Water Resources Division provides significant information on ground water resources for the City, especially Brooklyn and Queens. **Table 3.1** summarizes information from published references on the principal hydrogeologic units, primary locations and their water bearing properties. Although there are several classifications, Pleistocene and Cretaceous are the most significant deposits associated with **GHP** systems.

Pleistocene materials were deposited during the last glacial period and generally contain large volumes of ground water. As glaciers advanced from the north, scouring and eroding the top of bedrock, they entrained sand, clay and rock fragments of various sizes into the ice mass. As the glaciers receded, the meltwater deposited this material at the surface, which presently makes up the upper Pleistocene. These surficial deposits form the upper glacial aquifer and consist of glacial outwash and two types of glacial till, terminal and ground moraine. **Figure 3.2** outlines the general extent and location of these deposits in the city.

Table 3.1

Summary of Unconsolidated Deposits

Geologic Time	Geologic Unit	Hydrogeologic Unit	Range of Thickness (ft.)	Characteristics	Water Bearing Properties	Location by Borough
Pleistocene 10,000 years to 1.8 million years B.P.	Till (ground and terminal moraine)	Upper glacial aquifer	0 to 300	Till (mostly along north shore and in moraines) composed of clay, sand, gravel, and boulders	Difficult drilling conditions Till has low permeability	All boroughs
	Outwash deposits			Outwash deposits (mostly between and south of terminal moraines, but also inter-layered with till) consist of quartzose sand, fine to very coarse, and gravel, pebble to boulder sized	Outwash deposits are moderately to high permeability	
	Gardiners clay (marine deposits)	Gardiners clay	0 to 150	Clay, silt, and few layers of sand and gravel. Contains marine shells.	Poor permeability	Brooklyn, Queens, and Staten Island
	Jameco Gravel	Jameco aquifer	0 to 200	Sand, fine to coarse, and gravel to large-pebble size, few layers of clay and silt	Moderately to high permeability Contains mostly fresh water, but brackish water and water with high iron content locally in southern Queens	Brooklyn and Queens
Cretaceous 65 million years to 145 million years B.P.	Magothy Formation	Magothy aquifer	0 to 500	Sand, fine to medium clayey in part; interbedded with lenses and layers of coarse sand and sandy and solid clay	Most layers are poorly to moderately permeable, some locally are highly permeable. Water is unconfined in uppermost parts, elsewhere is confined. Water is generally of excellent quality, but locally has high iron content along north and south shores	Brooklyn and Queens
	Raritan Clay Unit	Raritan clay	0 to 200	Clay, solid and silty, few lenses and layers of sand, litter gravel	Poor to very poor permeability constitutes confining layer for underlying Lloyd aquifer. Very few wells produce appreciable water from these deposits	Brooklyn, Queens, and Staten Island
	Lloyd Sand Member	Lloyd aquifer	0 to 300	Sand, fine to coarse, and gravel, commonly with clayey matrix, some lenses and layers of solid and silty clay	Poor to very poor permeability. Water is confined under artesian pressure by overlying Raritan clay, generally of excellent quality, and locally high iron	Brooklyn, Queens, and Staten Island

Figure 3.2

Distribution of Surficial Deposits in New York City



Geology and Hydrogeology

The Upper Glacial aquifer is the thickest and most extensive aquifer in the city, providing as much as 1,500 gpm in yield. The [USGS](#) reports that till generally has a lower hydraulic conductivity than the outwash, although hydraulic testing for some geothermal systems in Brooklyn have shown these deposits to be very productive.

The terminal moraine is a till that was deposited along the leading edge of the glacier where it stopped for a period of time. It also marks the southernmost extent of the glaciers in New York City and forms a prominent topographic ridge that passes through central Brooklyn, Queens and southern Staten Island in a general north-east-southwest direction. Ground moraine is till that was deposited beneath the glaciers as they melted and is found north of the terminal moraine throughout all five boroughs. Till commonly contains boulders and cobbles that can severely hamper or prevent drilling. However, it generally becomes sandier with increasing depth and contains less cobbles and boulders.

Glacial outwash was deposited from meltwater downstream of the glacier's southern edge and exists primarily south of the terminal moraine in Brooklyn, Queens, and Staten Island. Outwash deposits are mostly composed of sand and gravel.

The Gardiners Clay and Jameco aquifers are the two deep-lying Pleistocene deposits with the Jameco being deeper and older. Wells tapping this aquifer have yielded up to 1,600 gpm, and depending on the ground water quality, may be suitable for an open loop system. The overlying Gardiners Clay does protect the underlying Jameco aquifer from surficial man-made pollutants, but creates confined ground water conditions. Wells installed in this aquifer have a wider area of hydraulic influence and must be spaced farther apart to avoid well interference.

Cretaceous deposits are the deepest and oldest, directly overlying the bedrock surface, and are present in Brooklyn, Queens and Staten Island. Two aquifers, the Magothy and the Lloyd, located in Brooklyn and Queens have been used extensively as a source of ground water supply. The Magothy aquifer has yielded as much as 1,600 gpm and reaches a maximum thickness of 200 feet in southern Brooklyn, and 500 feet in southeastern Queens, according to USGS publications. This aquifer can yield sufficient ground water for most open loop systems.

The Lloyd aquifer is the deepest in Brooklyn, Queens and eastern Long Island with the oldest and most pristine ground water. In the City, it underlies southeastern Brooklyn and central and southeastern Queens. [NYSDEC](#) regulations prohibit drilling into the aquifer unless permitted for municipal ground water supply.

Geology and Hydrogeology

Consolidated Bedrock

Bedrock in the city is represented by several geologic formations. Reports and maps published by the [USGS](#) are significant sources of information for bedrock in the area. USGS engineering geology maps by Charles Baskerville, which are based on numerous tunneling projects, are also available for Manhattan and Bronx. [Figure 3.3](#) illustrates approximate depth to bedrock and the general distribution of geologic formations.

These formations are the result of geologic processes that include sedimentation and metamorphism spanning over a billion years. Each rock type is physically distinct and represents its own unique set of drilling conditions and requirements. For example, Manhattan Schist will require longer drilling times and may wear down standard drilling bits sooner because of its hardness, while Inwood Marble is softer and will require less time on average. [Figure 3.4](#) is a cross section of Manhattan just south of Central Park through north-western Queens. In this section, Manhattan Schist primarily underlies the Hartland Formation, except at Roosevelt Island where Inwood Marble and Fordham Gneiss outcrop at the surface. The section also shows Ravenswood Granodiorite exposed along the western edge of Queens, which is the only area where bedrock is visible in the borough.

Bedrock is not always homogeneous, and may be solid, fractured, extensively weathered or a combination thereof. Deeper formations tend to be less fractured because of overlying pressures and consolidation of materials. In contrast, shallow bedrock within 100 feet of the surface is generally more fractured. Also, fractures and faults may occur at boundaries between different geologic formations. The upper surface of bedrock in contact with overlying unconsolidated deposits is typically weathered and decomposed.

Unlike unconsolidated deposits, bedrock is generally not permeable. However, ground water can collect in fractures and faults to create a bedrock aquifer. The size and degree of interconnection between the fractures will determine permeability and the sustainable yield. While major faults have been mapped, faults and fractures at a specific location can only be verified through drilling and seismic surveys. As a result, bedrock wells do not characteristically have great sustainable yields with rare exceptions.

Figure 3.3
Generalized Distribution of Bedrock Formations

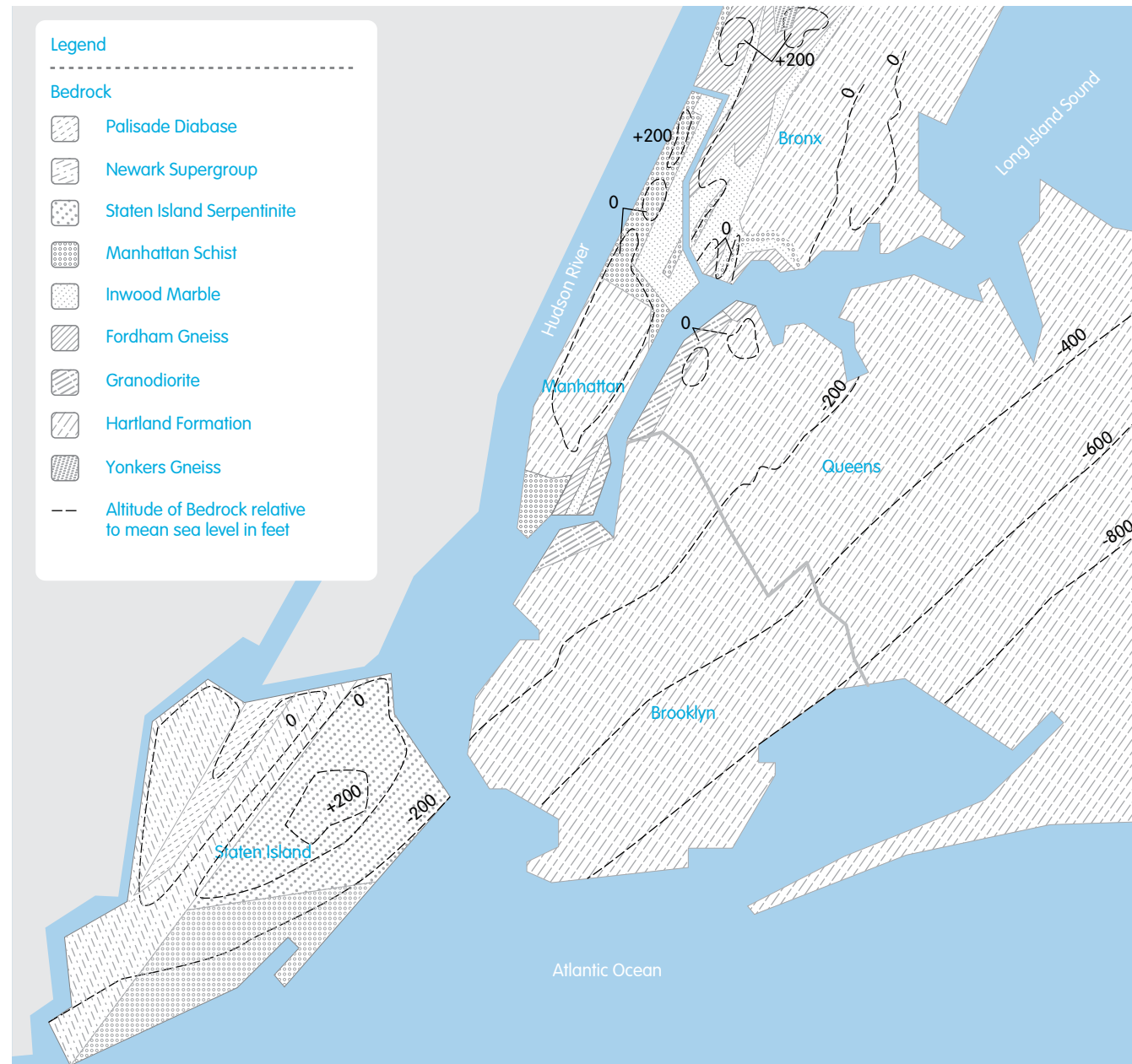
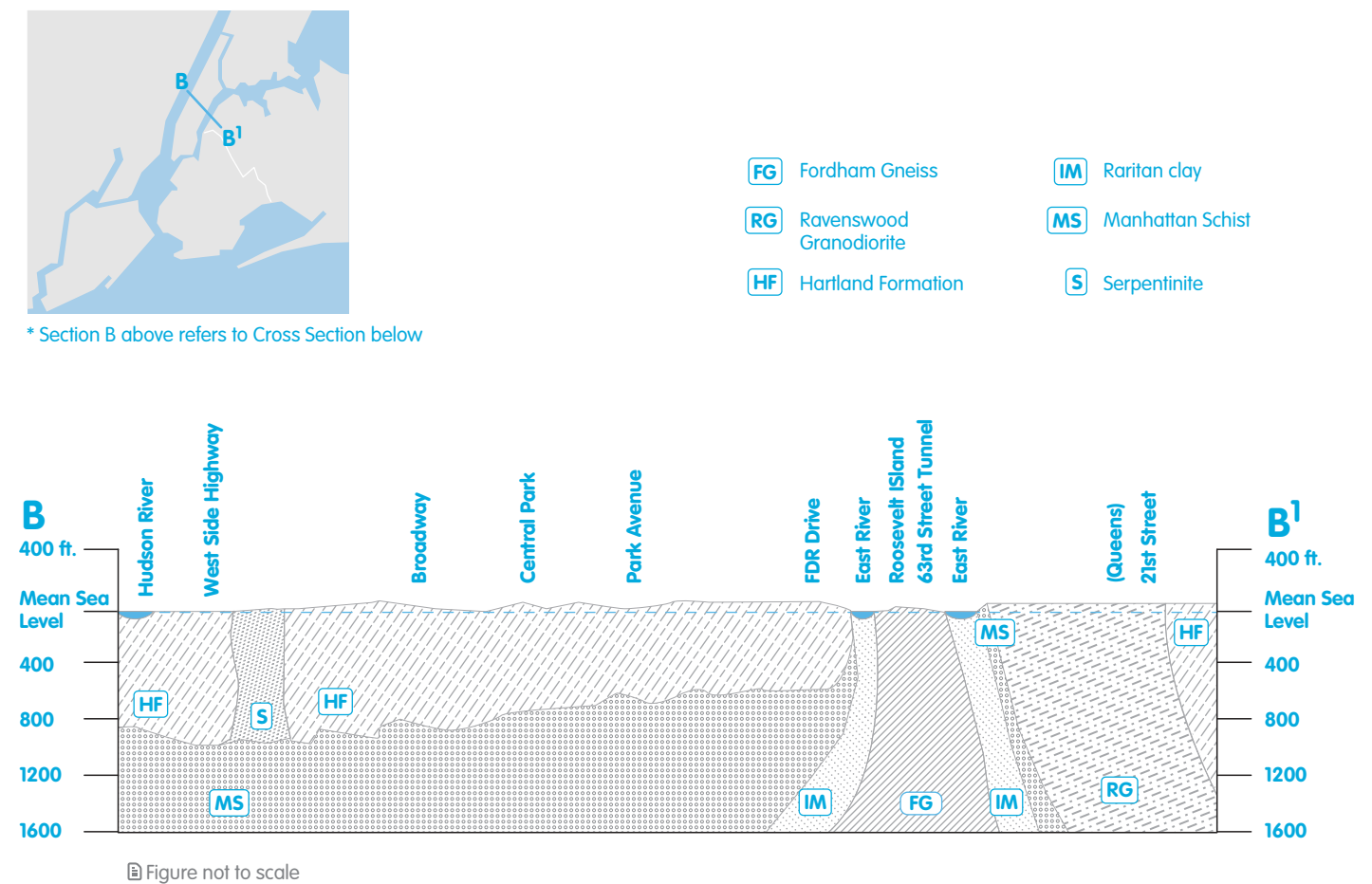


Figure 3.4
Geologic Cross-Section of Manhattan



Ground Water Occurrence

Ground water originates from precipitation, which infiltrates and recharges the ground, moving through soil, unconsolidated deposits and bedrock aquifers via capillary action and gravity. In New York City, leaking water mains and sewers can also be a significant source for ground water recharge. The surface of ground water at atmospheric pressure is known as the water table and separates the unsaturated materials from water bearing aquifers. Ground water continues to move naturally from higher to lower elevations, and over time, may discharge to adjacent rivers or ocean.

Because ground water is principally held in the pore space of unconsolidated deposits, aquifers with the most abundant yield are found in Brooklyn and Queens. Areas with bedrock close to the surface, such as Manhattan and Bronx, typically provide minimal ground water yield. Exceptions occur where bedrock wells intercept a large network of fractures and are able to provide sufficient ground water. However, bedrock fractures are difficult to locate and determining yields require drilling or other diagnostic instruments.

Ground water presence is an important factor in determining the suitability of a **GHP** system. Open loop systems will only be applicable for sites with consistently available ground water for supply. Other systems will benefit from the additional thermal capacity gained from surrounding ground water. In addition, because ground water continues to move, the direction of flow should also be investigated and incorporated into **GRCO** design. Other ground water issues, such as quality, will also affect system design and maintenance procedures.

3.3 Site Investigation

Appropriate **GHP** system selection and subsequent design requires accurate and complete site analysis. Research and subsurface investigations are more extensive than those performed for conventional **HVAC** projects because of the impact site conditions may have on the **GRCO**. Project teams will need detailed information such as existing hydrogeologic conditions to verify the feasibility of different systems and potential capacities.

Published information on New York City's geology is readily available and provides general information for proposed project locations. However, drilling and testing are the only reliable means to accurately characterize a site. A field testing program may be necessary to verify certain properties such as the thermal capacity of a well location. The project team should also investigate nearby sites and confirm any underground structures that may impact system design. A qualified professional geologist or geotechnical engineer will be able to help gather the necessary information for analysis. Even with the best preparation during design, drilling methods and well construction may need to be modified in the field to address unexpected conditions.

Hydrogeologic Properties

Since geology can vary widely even on a small site, appropriate testing to determine specific hydrogeologic properties should be conducted early in the design phase. Certain conditions will preclude some **GRCO** types while favoring others. The following properties can affect system design considerably and should be fully investigated prior to system selection:

Type of geologic unit: The type of bedrock or unconsolidated deposit will provide overall site characteristics, such as permeability and ease of drilling.

Depth to bedrock **DTB:** Primarily affects the cost of installation.

Depth to ground water **DTW:** Affects pumping costs during operation.

Ground water yield: Higher yields allow closer well spacing in open loop and SCW systems.

Ground water quality: Water quality is critical for open loop and SCW systems where water comes into direct contact with equipment.

Direction of ground water flow: Flow is critical to open loop systems and increases thermal capacity in all three systems.

Aquifer thickness: The thickness of an aquifer will affect the design and location of well screens for open loop and **SCW** systems.

Table 3.3 summarizes the impact that each property has on the GRCOs. Although these properties are the major parameters in system design, permeability and hydraulic conductivity are also important factors.

Table 3.3

Evaluation of Hydrogeologic Conditions by GRCO

System Type	Closed Loop	Open Loop	Standing Column Well
Geologic Unit	<p>Unconsolidated deposits Water-bearing sand and gravel aquifer optimal. Has high thermal conductivity. Silty/clayey material has low thermal conductivity. Glacial deposits present difficult drilling.</p> <p>Bedrock Serpentinite in bedrock may contain asbestos.</p> <p>Fractured rock can break off within borehole and impact loop installation and grouting.</p>	<p>Unconsolidated deposits Permeable sand and gravel aquifer optimal. Avoid locating screen in silty/clayey materials. Glacial deposits present difficult drilling.</p> <p>Bedrock Generally not suitable.</p>	<p>Unconsolidated deposits Not effected by conditions in unconsolidated deposits. Surface casing seals off well from unconsolidated deposits. Saturated unconsolidated deposits around the surface casing contribute to thermal capacity.</p> <p>Bedrock Inwood Marble may not support a permanent free-standing bedrock well. Fordham Gneiss may yield low/no ground water for bleed. Serpentine may contain asbestos.</p> <p>Fractured rock provides higher ground water yield for bleed but can also break off within borehole and impact drilling or fill in around the shroud in the future.</p>
Depth to Bedrock (DTB)	Most cost-effective if bedrock is shallow.	Not applicable.	Shallow depth to bedrock provides maximum well exposure for heat exchange. Least amount of steel casing reduces cost. DTB greater than 100 ft. may prohibitively increase the cost of casing.
Depth to ground water (DTW)	Unaffected by DTW. Loop thermal capacity higher with shallower DTW.	DTW 25 to 30 ft. minimizes pumping costs, and mounding around diffusion wells with less risk of wellhead flooding. DTW greater than 100 ft. deep may increase pumping cost. Greater risk of wellhead flooding with DTW less than 10 ft.	DTW 25 to 50 ft. minimizes pumping costs. DTW greater than 100 ft. may prohibitively increase pumping costs. Greater risk of wellhead flooding with DTW less than 10 ft.

System Type	Closed Loop	Open Loop	Standing Column Well
Ground Water Yield	Unaffected by yield.	High yield allows closer spacing of supply and diffusion wells with less risk of thermal short circuiting.	Minimum 10 gpm is optimal for bleed to maximize well capacity. Lower yield reduces well's thermal capacity.
Ground Water Quality	Unaffected by ground water quality.	Ground water with high levels of organic and inorganic compounds, such as iron, iron bacteria, organic carbon, and organic pollutants, is not suitable.	High suspended sediment, corrosive ground water conditions and mineralization can impact submersible pumps, heat pumps and heat exchangers, if used.
Direction of Ground Water Flow	Loop layout should be oriented to take advantage of natural flow.	Supply well should be upgradient of diffusion wells.	Unaffected by flow direction.
Aquifer Thickness	Unaffected by aquifer thickness.	Aquifer should be deep enough to maximize screen depth.	Unaffected by aquifer thickness.

Site Investigations

Underground Infrastructure

Underground infrastructure may impact a **GHP** project in numerous ways. Drilling may be restricted, additional permits may be required, and construction may increase costs. Water and transportation tunnels are the two primary structures that should be confirmed early on, and any potential impacts to the schedule or construction should be evaluated.

The [New York City Department of Environmental Protection \(NYCDEP\)](#) has jurisdiction over the construction, operation, and safety of the city's potable water supply system and water tunnels. According to the [USGS](#) and NYCDEP, tunnels lie approximately 500 to 700 feet below ground surface in bedrock. Standing column well projects are most affected by NYCDEP regulations since they are typically drilled below this depth.

Drilling drift on standing column well projects has also become an issue within recent years. Deep boreholes typically drift from plumbness for numerous reasons. While some drift is unavoidable, specialized methods can be employed to ensure drilling a straighter hole. In response, the [New York City Department of Transportation \(NYCDOT\)](#) and NYCDEP have issued strict requirements and procedures for drilling deep wells between 200 to 500 feet of the city's water tunnels. However, measures to control and monitor drift will increase the typical drilling time and costs.

In the case of transportation tunnels, such as subway, train and vehicular tunnels, review and approval of drilling locations is required if sited less than 200 feet from a tunnel. Relevant agencies include the

Metropolitan Transit Authority (MTA), which manages New York City Transit (NYCT), Long Island Railroad (LIRR) and MetroNorth, and the Port Authority of New York and New Jersey (PANYNJ), which manages Hudson River tunnels. Coordination with these agencies should be considered a critical filing with four to six months of lead time included in the schedule. Discussions and meetings with these agencies should be initiated at least six months before drilling.

Environmental Considerations

Contaminated ground water poses potential permitting obstacles to an open loop system and may also significantly disrupt system operation and maintenance. If contaminants exceed the [NYSDEC](#) ground water effluent limits, an operating permit may not be issued. In addition, drilling through contaminated material usually generates drill cuttings that may need special disposal at a premium cost.

Building on sites with known environmental conditions are typically restricted, however, adjacent properties may impact ground water and the project's expectations of ground water use if contamination is upgradient from the project site. At a minimum, the design team should obtain and review current environmental database information and historic Sanborn maps to assess any environmental impact from the site itself and neighboring sites. Conditions which could be of concern include sites with leaking petroleum or underground chemical storage tanks (USTs), hazardous waste disposal, dry cleaners, and where hazardous materials or waste have been used, stored or generated.

Site Investigations

Adjacent Properties

The thermal and hydraulic influence of a **GHP** system extends beyond a well or loop, and will vary by **GRCO** type. Hypothetically, it is possible that in a dense, urban environment, a GHP system on one property can impact systems on adjacent properties. In particular, if wells or loops are installed close to the site boundary, the potential for interference with adjacent properties increases. On at least one **SCW** project in the city, neighboring property owners raised the issue of thermal rights, which may become a major concern as more systems are installed close together in urban areas.

The thermal effect around a SCW is more extensive than a closed loop field because the wells are much deeper and spaced farther apart on a site. However, the effect should be seasonal with a properly sized system, being most pronounced near the end of each season. The effect subsequently dissipates over the fall and spring seasons. System size and building load profile will determine the extent of any thermal effects.

The thermal effect of an open loop system is markedly different than the other GRCOs. Discharge water, which may be warmer or colder than the ground water, is released back into the aquifer through diffusion wells. Ground water is recharged as it flows through the

surrounding material and mixes with ambient temperature water. It is possible that the discharge water could be drawn into a supply well on a neighboring property before fully returning to ambient temperatures and affect neighboring ground water usage. Factors such as pumping, well spacing, and hydraulic properties of the aquifer are also necessary to determine the possible effect.

Drawdown around an open loop supply well and mounding around the diffusion wells can also influence water levels on an adjacent property. Similarly, a SCW system could lower water levels beyond the site boundary during prolonged bleed. The extent of any hydraulic effect would be dependent on the site's hydrogeology, spacing between the wells on the two properties, rates of pumping, diffusion or bleed.

The presence of any nearby existing GHP systems or ground water supply wells should be investigated prior to GRCO selection. If any systems or wells are identified, hydraulic calculations and computer modeling should be performed to assess the potential interference between the two systems.

3.4 Feasibility Analysis

As information is confirmed through various site investigations, the design team should analyze and evaluate each **GRCO** to determine which system will be best suited for the project. One or more GRCO types may be appropriate depending on physical site characteristics. However, project issues such as project budget or scheduling may require a different option altogether.

As a starting point, suitable GRCO types based on each borough's hydrogeologic characteristics is outlined in **Table 3.5**. The table only identifies potential systems and does not supplant actual site investigations. Closed loop systems are generally the most flexible, but require the most space. Open loop systems require sufficient ground water, which is prevalent in Brooklyn and Queens, but not typical of areas with bedrock. Standing column wells are most suitable in areas with a shallow depth to bedrock, typically found in Bronx and Manhattan.

Table 3.5
GRCO Suitability by Borough

NYC Borough (County)	Closed Loop	Open Loop	Standing Column Well
Bronx (Bronx)	Suitable	Not suitable	Suitable
Brooklyn (Kings)	Suitable except: Must avoid area affected by Greenpoint oil spill	Ground water quality must be suitable Cannot use the Lloyd aquifer Avoid Greenpoint oil spill or other contaminated areas	Suitable only in northwest corner of borough along East River, where bedrock is shallow
Manhattan (New York)	Suitable	Suitable at southern tip and center of borough, contingent on ground water quality	Suitable DTW may be excessive in the upper west side area
Staten Island (Richmond)	Suitable	Suitable in western and eastern areas	Suitable except: Drilling locations must be >200 ft. from the water tunnel in the northeast DTW may be excessive in central areas
Queens (Queens)	Suitable	Ground water quality must be acceptable Cannot use the Lloyd aquifer	Not suitable except in areas of shallow bedrock

Feasibility Analysis

Closed Loop

Closed loop systems operate independent of hydraulic conditions beneath the site, and are potentially feasible throughout the city as illustrated in [Figure 3.6](#). However, an unobstructed outdoor space is required for drilling and system installation. Typically, the recommended spacing of 20 feet between loops will translate to 400 square feet of area per well. A relatively large area must be available to accommodate the numerous loops required to meet the load of a medium sized commercial building or a closed loop system will not be appropriate. ¹

Actual loop design requires exact calculations based on numerous variables such as building loads, [GHP](#) operation, and thermal characteristics of the ground, piping material and grout. A test loop installation is necessary to confirm thermal conductivity and diffusivity of subsurface materials. Results are then used to determine the appropriate loop field design relative to the building load profile. For estimating purposes, the total length of loop required is equal to the building's dominant peak load multiplied by the estimated unit thermal capacity, which ranges from 150 to 200 linear feet per one-ton in New York City. Depending on allowable loop depth and available area, the number of loops can be adjusted.

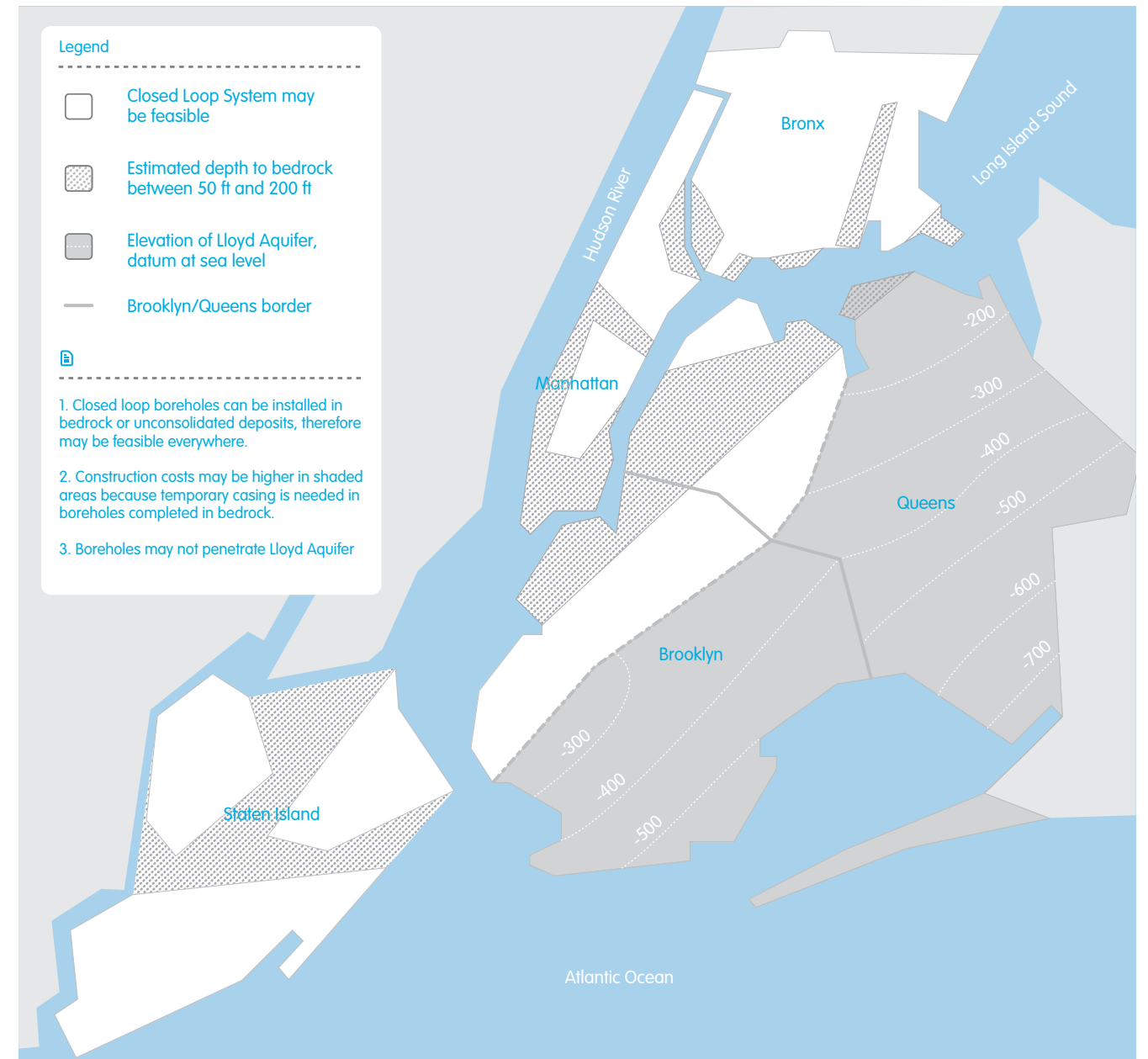
There is a trade-off between deep and shallow loops. While deeper loops require less space, horizontal piping and labor, they are more difficult to install, and depending on [DTB](#), may be more costly. Projects located in areas where bedrock is projected to be between 50 and 200 feet below grade could incur higher drilling costs from additional surface casing that may be required. Typically, the casing is removed and reused during multiple loop installation. When a loop is installed in both unconsolidated deposits and bedrock, the casing must remain in place to maintain the borehole. These conditions occur throughout the Bronx, Manhattan, most of Staten Island, and small areas in Brooklyn.

[Figure 3.6](#) outlines approximate areas where a closed loop system may encounter additional issues.

Loop depths are also limited in Brooklyn and Queens because of drilling restrictions into the Lloyd Aquifer. Based on current [USGS](#) hydrologic maps, the highest elevation of the Lloyd is approximately 200 feet below mean sea level (msl) in northern Queens and lowest at 700 feet below msl in southeastern Queens. The maximum drilling depth may vary considerably in these boroughs, but cannot exceed the upper limit of the Lloyd Aquifer.

Figure 3.6

Areas Suitable for Closed Loop Systems



¹ For more information on closed loop systems, see [Chapter 2 Ground Couplings - Closed Loop](#)

Feasibility Analysis

Closed loop systems are generally installed outdoors using conventional drilling equipment. While restricted-access rigs are available for installing loops within a building, indoor drilling is slower and more costly. Moreover, installing a closed loop field within the footprint of a new building requires careful system analysis and closer coordination between contractors.

Advantages

The main advantage of a closed loop system is that it is not dependent on ground water, as summarized in [Figure 3.7](#). Closed loops do not create drawdown or mounding of ground water levels that may affect future operation. While aquifer yield or ground water flow is not essential for operation, installing loops below the water table will increase the thermal capacity as water tends to increase thermal conductivity. Also, because the system is sealed off from the surrounding environment, it can be employed in areas with aggressive or contaminated ground water that otherwise would be detrimental to other systems.

A closed loop field does not require future access to the buried pipes. After installation, the area above the loop field may be used for playgrounds, courtyards, green spaces, parking areas and other functions that do not require deep excavations. These systems can be installed in fractured bedrock as long as the borehole remains open long enough to place and backfill the loop.

Disadvantages

Closed loop systems are less efficient than the other systems because of the thermal resistance or insulating effect created by the plastic pipes and grout. Even though thermally enhanced grout increases conductivity, the process is still inefficient since heat exchange between the building and ground is indirect. Greater loop length and land area is required to provide the same thermal capacity.

These systems can be more expensive than open loop systems because of the additional drilling and materials involved. The typical borehole depth of 500 feet is deeper than the wells in an open loop system, although significantly less than an [SCW](#). However, considerably more boreholes are required to achieve an equivalent capacity compared to an open loop or SCW system. [HDPE](#) piping in each borehole will also increase material and labor costs, which require testing of the grout and pipe circuits for proper installation.

Figure 3.7

Analysis of Closed Loop System

Advantages	Disadvantages	System Considerations
<p>Most reliable with the least maintenance compared to other GRCO types.</p> <p>System performance and thermal capacity are not dependent on aquifer yield.</p> <p>Not susceptible to scaling, corrosion, or biofouling because heat transfer fluid is isolated from contact with ground water.</p> <p>Access to loops not required after installation. Land over the loop field can be used for other limited purposes.</p> <p>No state or federal permits required if less than 500 ft. deep</p>	<p>Least efficient heat exchange with the ground because of insulating effect of plastic loop piping and grout backfill.</p> <p>Highest drilling footage, number of wells, and construction cost compared to other systems.</p> <p>Requires the most space and has the most site disturbance for trenching and piping compared to other systems.</p> <p>May require an anti-freeze solution</p> <p>Highest potential for conflicts with buried site utilities/structures.</p>	<p>Range in thermal capacity for a 500 ft. deep well is 2.5–3.3 tons (30–40 MBH) of heat transfer capacity.</p> <p>Recommended minimum loop spacing is 20 ft., or 400 sq ft. of land area required per loop. Typical depth is 200–500 ft.</p> <p>Loop depth and number depend on load profile, available land area, depth to bedrock, and drilling conditions.</p> <p>A test loop and thermal conductivity testing is essential for larger than 25 loop system. One test loop per 50 loops is recommended.</p> <p>Loops can be installed in either unconsolidated deposits or bedrock.</p>

Feasibility Analysis

Open Loop

Open loop systems require highly productive, permeable aquifers such as those found in Brooklyn and Queens. Much of Staten Island and isolated areas of Manhattan may also be suitable, as shown in [Figure 3.8](#). A site's hydrogeology is extremely critical to system design because heat energy is transferred directly from ground water. Aquifer properties such as **DTW** and direction of ground water flow are factors in determining well depth, pump sizes, and supply and diffusion well locations. ²

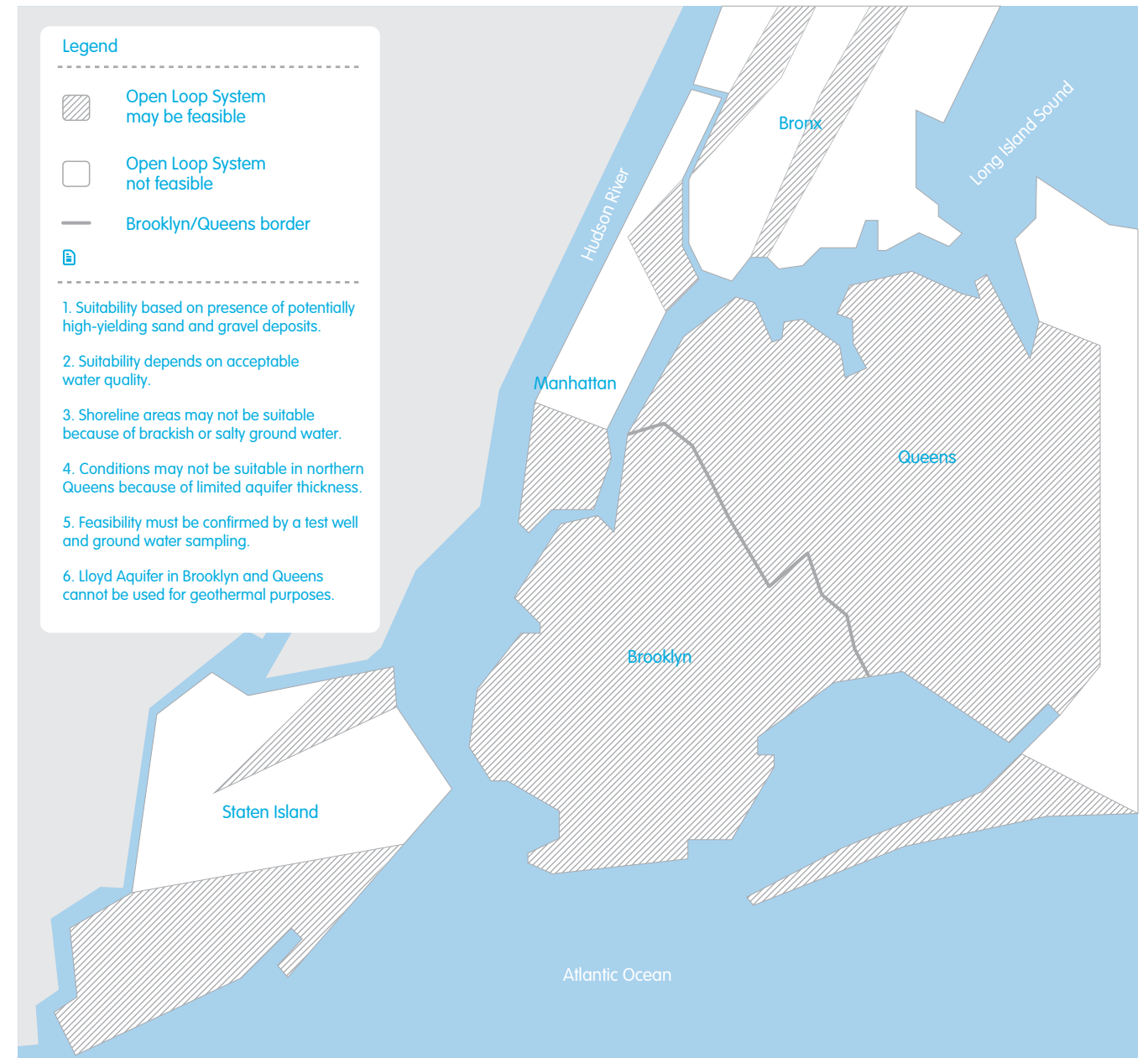
Preliminary hydraulic calculations using published aquifer data must be verified through field testing and analysis to verify actual characteristics such as permeability, hydraulic conductivity, and specific capacity. Installing a test well, conducting an aquifer pumping test and a borehole geophysical survey will confirm if there is sufficient yield to support building loads and help determine well design such as spacing, depth and screen length. A grain size analysis where a geologist collects and logs borings before sending to a laboratory is also necessary to determine screen location within the borehole and slot size opening.

Preliminary ground water sampling and analysis should also be performed prior to selecting an open loop system. Analysis involves field measurements such as temperature, pH levels and turbidity while other criteria such as volatile organic compounds, hardness and bacterial count are analyzed by a state approved laboratory. An experienced hydrogeologist or geochemist will analyze the results with respect to potential for scaling, biofouling, and corrosion. Potential corrosive conditions should alert designers to use plastic piping wherever possible, and dielectric fittings for joining piping of dissimilar metals. Other **GRCO** types should be reviewed if ground water quality is unacceptable.

Open loop systems require the least amount of drilling compared to other GRCOs. Typically, one supply well is used if yield is sufficient, but generally requires two diffusion wells for each supply to return water back to the aquifer. However, a project site may not be appropriate if well locations and minimum spacing cannot be accommodated.

Figure 3.8

Areas Suitable for Open Loop Systems



² For more information on open loop systems, see [Chapter 2 Ground Couplings - Open Loop](#)

Feasibility Analysis

Advantages

Open loop systems are generally more efficient and less expensive to install than the other **GRCO** types, as summarized in **Figure 3.9**. Thermal exchange happens immediately with ambient temperature ground water and eliminates the inefficiencies of using a separate fluid to transfer heat to and from the ground. Greater efficiency therefore allows the system to work with fewer wells. Typically in Brooklyn and Queens, one supply well is used for a 100-ton load, provided that ground water flow rate is sufficient at 1.5 to 3.0 gpm.

Fewer wells translate into lower drilling costs as well as lower costs for piping, trenching, and pumps. Since there are fewer system components, less site disturbance occurs during installation. Fewer conflicts exist with other underground systems because of the system's smaller footprint.

Disadvantages

Although directly using ground water increases efficiency, it may also be the source of many system problems. Ground water contaminants must first comply with regulatory limits for permitting. However, even within regulated limits, organic and inorganic compounds as well as certain types of bacteria in the aquifer can result in biofouling, corrosion, scaling or iron precipitation on system components.

Ground water conditions are subject to change for reasons beyond the building owner's control. Neighboring facilities may decide to install and operate similar geothermal systems or supply wells, which may affect the direction of ground water flow beneath the property and alter the ground water temperature. The impact of such changes must be considered, especially in a highly urban environment where adjacent properties are closely spaced.

Open loop systems can also have higher operation and maintenance costs. Access to wells is necessary for future servicing, including the submersible pumps. Costly well rehabilitation may be required depending on conditions within the aquifer and the effect on the screens and pumps.

Figure 3.9

Analysis of Open Loop System

Advantages	Disadvantages	System Considerations
<ul style="list-style-type: none"> Most efficient system because of direct thermal exchange with ground water at ambient temperature. Least amount of drilling and lowest installation costs. Smallest amount of well installations, piping, trenching, footprint, and site disturbances. Anti-freeze not used. Standard well drilling and construction methods used. Smallest amount of potential for conflicts with buried site utilities or structures. 	<ul style="list-style-type: none"> Most susceptible to scaling, corrosion, and/or biofouling from contact with poor ground water quality. Highest well maintenance. Maintaining minimum spacing between supply and diffusion wells to avoid hydraulic or thermal interference may not be possible. Excessive ground water pumping can affect water levels in nearby water supply or other geothermal wells. Requires future access to well head for pump and well servicing. Federal, state and local permits required. Permit may be denied if ground water is contaminated. 	<ul style="list-style-type: none"> Thermal capacity depends on ground water flow rate and ranges from 1.5–2 gallons per minute per ton or 12 MBH. Well depth and spacing depend on hydraulic conditions, pumping rates, duration, and regulatory requirements. Wells should be screened in permeable, unconsolidated deposits. Bedrock generally not suitable. Sampling is critical to confirm ground water quality before finalizing selection. A minimum of one test well and a pumping test are critical for design purposes and well layout. Backup well(s) to maintain system operation during servicing is recommended.



Can be configured as hybrid system with boilers or passive solar thermal system to supplement heating demand, and cooling towers or dry cooler to supplement cooling demand.

Feasibility Analysis

Standing Column Wells

Standing column wells rely on conductive heat transfer between circulating ground water and bedrock. A shallower **DTB** will provide greater thermal capacity and minimize material costs. Suitable areas include all of Bronx, Manhattan with exceptions in the south and central areas, most of Staten Island, and small areas in northern Brooklyn and Queens, as shown in [Figure 3.10](#). Areas with DTB greater than 100 feet will increase costs, which impacts the viability of an **SCW**. ³

A maximum **DTW** of 100 feet is also generally recommended to minimize pumping costs. Areas with deeper DTW correlate with high surface elevations, including northwest Manhattan and central Staten Island. Energy savings from utilizing a **GHP** in those areas may be negated by energy spent on pumping.

Well locations can be flexible as long as the recommended minimum spacing of 50 to 75 feet is maintained. Also, competent bedrock to the bottom of the well is needed for the borehole to be self-supporting. Otherwise, additional casing may be required and increase project costs. Access for future servicing should also be considered and outlined during design.

Bleed, if necessary, requires sufficient ground water yield and must discharge water to a suitable location, such as dedicated diffusion wells or surface water impoundments. Reuse in non-potable applications

such as irrigation or cooling tower make-up water is also recommended since bleed water cannot be discharged to the city sewer system per **NYCDEP** regulations. In addition, ground water quality must show relatively low suspended solids and mineralization, low chloride, hardness, organic carbon, organic pollutants, and a neutral pH.

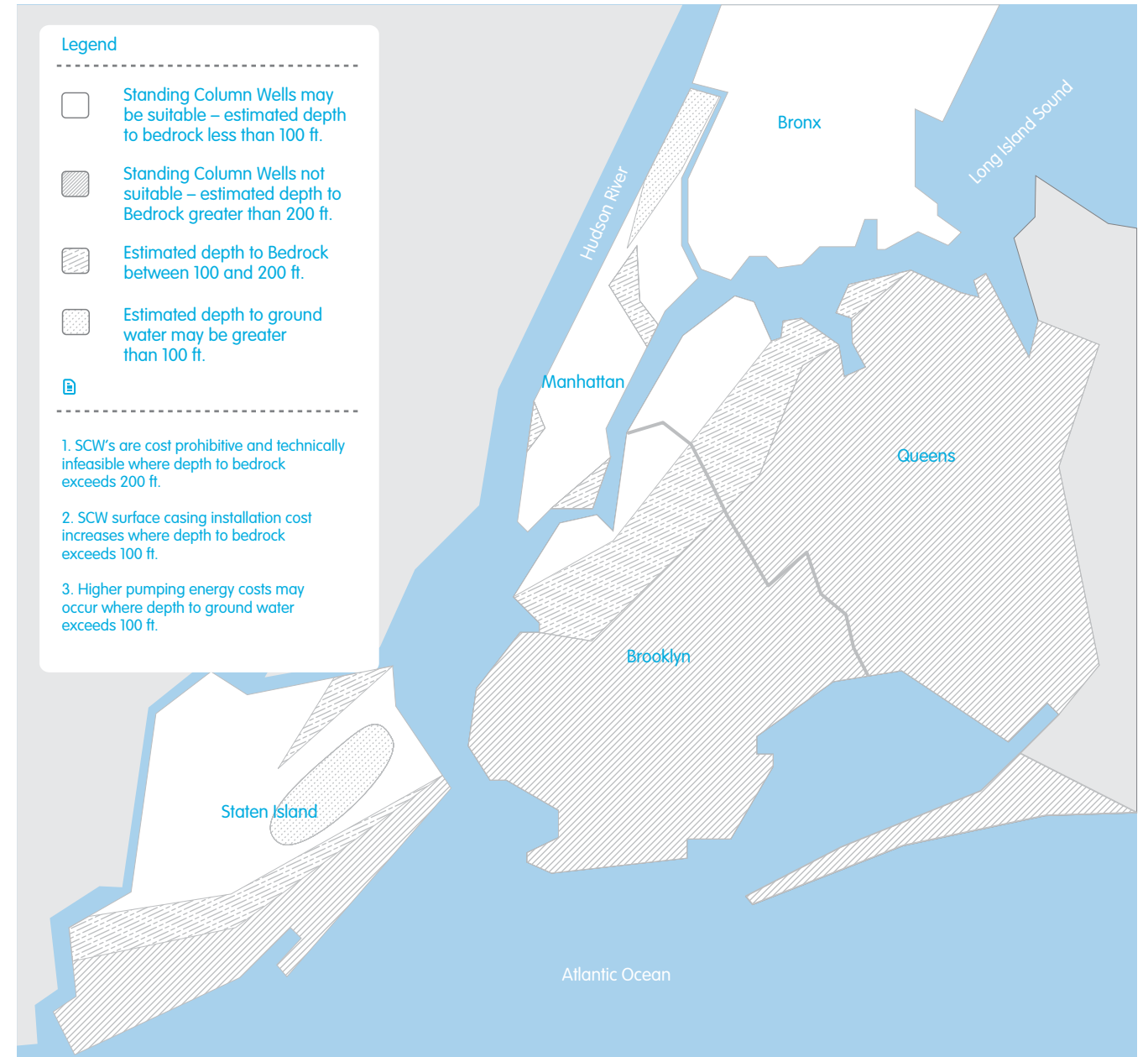
Advantages

SCWs maintain certain advantages over other GRCOs, as summarized in [Figure 3.11](#). While open loop systems require highly productive aquifers, SCWs operate with minimal ground water from fractured bedrock. Each well is also isolated from overlying unconsolidated deposits by a permanent steel casing. Consequently, SCWs normally do not directly affect nor are they affected by overlying aquifers.

When compared to a closed loop system, a **SCW** system offers greater efficiency, fewer wells and wider spacing. They are more efficient because circulating ground water comes directly into contact with the bedrock. One well can provide between 10 and 20 times more thermal capacity than a single closed loop well. Despite greater depths, the total amount of drilling required is substantially less, which results in lower installation costs. A smaller number of wells also consumes less area and can be more easily integrated into the overall site layout.

Figure 3.10

Areas Suitable for Standing Column Well Systems



³ For more information on SCW, see [Chapter 2 Ground Couplings - Standing Column Well](#)

Figure 3.11

Analysis of Standing Column Well System

Advantages	Disadvantages	System Considerations
<p>Significantly higher thermal capacity per well installation than closed loop, but less than open loop.</p> <p>Significantly less drilling required than closed loop system, resulting in less piping, trenching, and site disturbance.</p> <p>Flexible well locations, maintain 50–75 ft. spacing minimum</p> <p>No anti-freeze used.</p>	<p>Generally highest installation cost of all systems.</p> <p>Higher well maintenance than closed loop, but less than open loop.</p> <p>Susceptible to scaling, corrosion, and/or biofouling, but less than open loop.</p> <p>Ground water drawdown during bleed cycles can affect water levels in nearby supply wells or other geothermal wells, but less than open loop.</p> <p>Susceptible to sediment in return water. Potentially susceptible to water circulation problems because of sedimentation around shroud.</p> <p>Susceptible to return flow balancing issues if multiple wells are combined into single manifold.</p> <p>Requires future access to well head for servicing.</p> <p>State and federal permits required.</p>	<p>Range in thermal capacity for a 1,500 ft. well is 15–42 tons (180–500 MBH) of heat transfer capacity.</p> <p>Recommended minimum well spacing is 50–75 ft.</p> <p>Well depth depends on building load and number of wells that can be located on the site. Typical depth is 1,500 ft.</p> <p>Test well is advisable for systems with 8 or more wells. May not be cost-effective for smaller systems.</p> <p>Should include a contingency for additional and/or deeper wells if actual well yields are less than design bleed flow rate.</p> <p>Optimal conditions include a shallow DTB, generally less than 100 ft.</p> <p>Bedrock with moderate yields for bleed provide highest capacity, but requires suitable discharge location for bleed water.</p>

Can be configured as hybrid system with boilers or passive solar thermal system to supplement heating demand, and cooling towers or dry cooler to supplement cooling demand.

Feasibility Analysis

Disadvantages

In New York City, a **SCW** system may incur the highest construction cost. Drilling is slower, larger in diameter, and involves installing a casing into bedrock. Experience has shown that the steel casing installation accounts for as much as one-third of the total cost, even though the casing is less than 10 percent of the total well depth. Ground water quality can also be a concern, and as a result, operation and maintenance costs are generally higher than closed loop systems.

Thermal capacity is greatest for boreholes that intersect water bearing fractures, allowing for potential bleed. However, drilling through highly fractured bedrock has higher potential for unstable sidewalls and collapsing rock conditions within the boreholes. It is also possible over time for material to seep into the bottom of the well and impact water circulation in the annulus.

A test well to verify site conditions may not necessarily be representative of all drilling locations since variations can exist even over short distances. Because of variability in the subsurface environment, well yield is highly irregular with some wells performing better than others. As a result, multiple, low yielding wells may necessitate more installations to meet the building loads than originally planned. Even when a test well is successful, there is some risk that the geology at other well locations may differ enough that they are not optimal for a SCW system.

Similar to other GRCOs, most of these disadvantages can be addressed during the design phase or through contingency measures implemented during construction. For example, if ground water quality is questionable, adding a plate-frame heat exchanger into the design will minimize future maintenance issues. Contract documents should include alternate line items for contingency activities such as installation of permanent steel sleeves to support unstable rock zones.



4.0 List of Abbreviations

AHU Air Handling Unit	BMS Building Management System	COP Coefficient of Performance	FCU Fan Coil Unit
GHP Geothermal Heat Pump	EER Energy Efficiency Ratio	EWT Entering Water Temperature	GRCO Ground Coupling
HCFC Hydrochlorofluorocarbons	HDPE High-Density Polyethylene	HTF Heat Transfer Fluid	HVAC Heating, Ventilation, and Air Conditioning
HX Heat Exchanger	ODP Ozone Depletion Potential	SCW Standing Column Well	VFD Variable Frequency Drive

4.1 GHP System Design

GHP system design is similar to designs for conventional **HVAC** equipment. An ASHRAE based method of heating and cooling load analysis is required to properly size equipment and optimize distribution for building spaces served. However, since GHP units rely on heat exchange with the ground, **GRCO** design will require specialized expertise not common to conventional HVAC equipment.

An accurate load analysis is particularly critical for properly sizing the GRCO. Although there are costs and operational issues affecting both conventional and GHP systems, rule-of-thumb calculations can have a greater detrimental impact on GHP systems. When HVAC equipment or a GRCO is oversized based on estimated peak load requirements an increase in capital costs can occur depending on the GRCO type. The additional GRCO cost may be a significant increase to the project budget owing to extra drilling.

Conversely, an undersized GHP system will result in reduced capacity or even lead to failure if continually operated beyond design capacity. With limited options for capacity adjustment, correcting an undersized GRCO will be more expensive in the long term. Consequently, heating and cooling load analysis should be carefully performed to produce a GRCO design that better matches the building's needs.

4.2 Load Analysis and Sizing

An accurate load analysis begins with a close examination of the building, its location and use. Factors to investigate and determine include outdoor/indoor design conditions, building construction, orientation, climate, occupancy and schedule of use. Buildings will have an annual load that reflects building operation under normal conditions throughout a typical year as well as peak loads that occur during peak demand periods, such as summer solar gains or extreme winter temperatures.

Space conditioning systems are typically sized to meet the peak load, even though the equipment will operate well below the peak demand for much of the time. If both heating and cooling are provided, the peak dominant load will determine the size of the equipment as well as the **GRCO** for **GHP** systems.

GRCO Systems and Loads

A **GHP** unit is a water-source heat pump and must maintain an optimal range of **entering water temperatures EWT** to operate efficiently ¹. For closed loop and **SCW** systems, EWT is dependent on heat exchange with the ground primarily through conduction. The total loop length or well depth available is directly proportional to the amount of heat exchange required. Consequently, when load analyses do not accurately account for building conditions or uses, the **GRCO** system will be improperly sized, resulting in either greater installation costs or reduced system performance. Open loop systems are different in that they require certain flow rates to achieve an optimal EWT range rather than thermal conduction. Although additional supply wells may be needed, the flow rate can be manipulated through larger pumps, which has a lesser cost impact.

Even with great care in analyzing loads and field testing, designing the GRCO is not a simple process based on a single calculation. Since design inputs are assumptions based on historical weather data and expected occupancy patterns, there can be significant variation once the building is occupied and in operation. Natural variations in the thermal and hydraulic properties throughout a site are also difficult to predict and may affect the GRCO design. For instance, if ground water is present, the thermal capacity may be increased for closed loop and SCW systems and drilling depths may be reduced. However, allowing for increased capacity should be verified through computer modeling and not extend into the design factor of safety.

Equipment and GRCO Sizing

Similarly, a mechanical engineer will typically evaluate building loads and select the appropriate equipment, sized to meet the estimated peak demand. However, sizing the **GRCO** is a separate process and will depend on the system type as closed loop systems will have greater requirements than open loop systems. While rule-of-thumb estimates and engineering equations are available for preliminary analysis, a successful GRCO design requires verifying site specific properties such as thermal conductivity, sustainable well yield, and available **EWT**. A geothermal engineer or a mechanical engineer with the requisite **GHP** system experience will include these factors in determining the GRCO size, depth and layout needed to meet demand.

¹ For more information on GHP units, see [Chapter 2 Geothermal Heat Pumps](#).

Load Imbalances

With tighter building envelopes and higher lighting loads, most commercial and institutional buildings are in reality cooling dominant. Consequently, the cooling loads are more often greater than the heating demand, and these buildings will tend to reject more heat into the ground than it removes on an annual basis. The **GRCO** must be designed to handle an imbalanced load condition, particularly in closed loop and **SCW** systems. Imbalanced loads do not significantly impact a properly designed open loop system where supply and diffusion wells are sufficiently spaced and appropriately located.

The refrigeration cycle used in the heat pump also contributes to a load imbalance. During heating, the GRCO only needs to provide approximately 70% of the heating load required since heat generated by the **GHP** motors can be recovered for space conditioning. However, the GRCO will need to absorb both the heat rejected from the building and the heat generated by the motors, which is approximately 25-30% higher than the cooling load. The load imbalance already in cooling dominant buildings is therefore further exacerbated.

If a cooling load imbalance is not addressed, the GRCO may not be able to effectively dissipate excess heat. Ground temperatures will rise over time and lead to a steady increase in **EWI**. As temperatures approach the upper range of efficiency, overall system efficiency drops and electrical energy costs increase.

The GRCO design may be able to accommodate smaller imbalances through deeper wells or greater spacing of boreholes and wells. If there is excessive heat rejection to the ground, integrating a cooling tower or dry cooler in a hybrid configuration can relieve some of the imbalance. The design team should review both options as part of system design rather than waiting for operational issues to develop.

4.3 GHP Configurations

Various sizes and configurations of GHPs allow the design team to select the best fit for the building. Horizontal, vertical, console, split, and stacked units are readily available in a wide range of load capacities. 'Right' sizing avoids short cycling, thermal comfort disruption and efficiency losses from oversizing equipment. Dimensions vary with capacity, and additional features such as dehumidifiers and fresh air devices can be integrated.

Some manufacturers have variable speed, dual stage or dual speed compressors that allow the heat pumps to better satisfy heating and cooling loads. Multiple capacity units allow greater occupant comfort, higher operating efficiency, and lower operating costs. However, these advantages must be weighed against typically higher first cost and greater unit complexity. Two speed GHPs offer superior performance when operating at low speed but sometimes are less efficient at high speed than single speed units.

GHPs can be located in a central mechanical room or distributed throughout the building located in or near conditioned spaces. Mechanical room requirements for a distributed system are modest compared to a centralized space. Distributed systems require less ductwork, although maintenance may be more disruptive to building program activities depending on location. Horizontal units are generally located in ceiling spaces, circulation spaces, or elsewhere to minimize sound in occupied places. Vertical units can be placed in closets, mechanical equipment rooms or storage rooms. The units may be ceiling hung or floor-mounted with limited duct runs or grouped in mechanical rooms. Vibration absorber support units are a recommended option, available with most units.

Distributing units throughout the building will require an interior water loop to connect with the **GRCO**. A separate circulator pump for the loop and associated equipment and controls are normally located in a central mechanical space. Generally, a piped distribution system is less expensive than a ducted one and takes up less space.

Each unit is able to operate in heating or cooling mode at any time therefore, simultaneous heating and cooling can be provided, which is useful in the swing seasons when some spaces may require heating and others cooling. Large, high-occupancy use zones may require cooling and ventilation only, even during the heating season. Diversification reduces operational costs as well as the net load handled by the GRCO and should be considered during system design.

Water-to-Air

Water-to-air GHP supply conditioned air through ductwork from a central unit or directly within a space as a terminal unit. **Figure 4.1** shows a centralized **GHP** unit while **Figure 4.2** illustrates a simplified distributed GHP layout. These are typically packaged units that contain all necessary components such as the heat exchanger, air coils, compressor, and fans. An optional external plate-frame heat exchanger may be used if water quality is a concern for the equipment. If perimeter tempering is required, console style units may be used along the exterior walls.

Figure 4.1
Centralized Water-to-Air GHP System

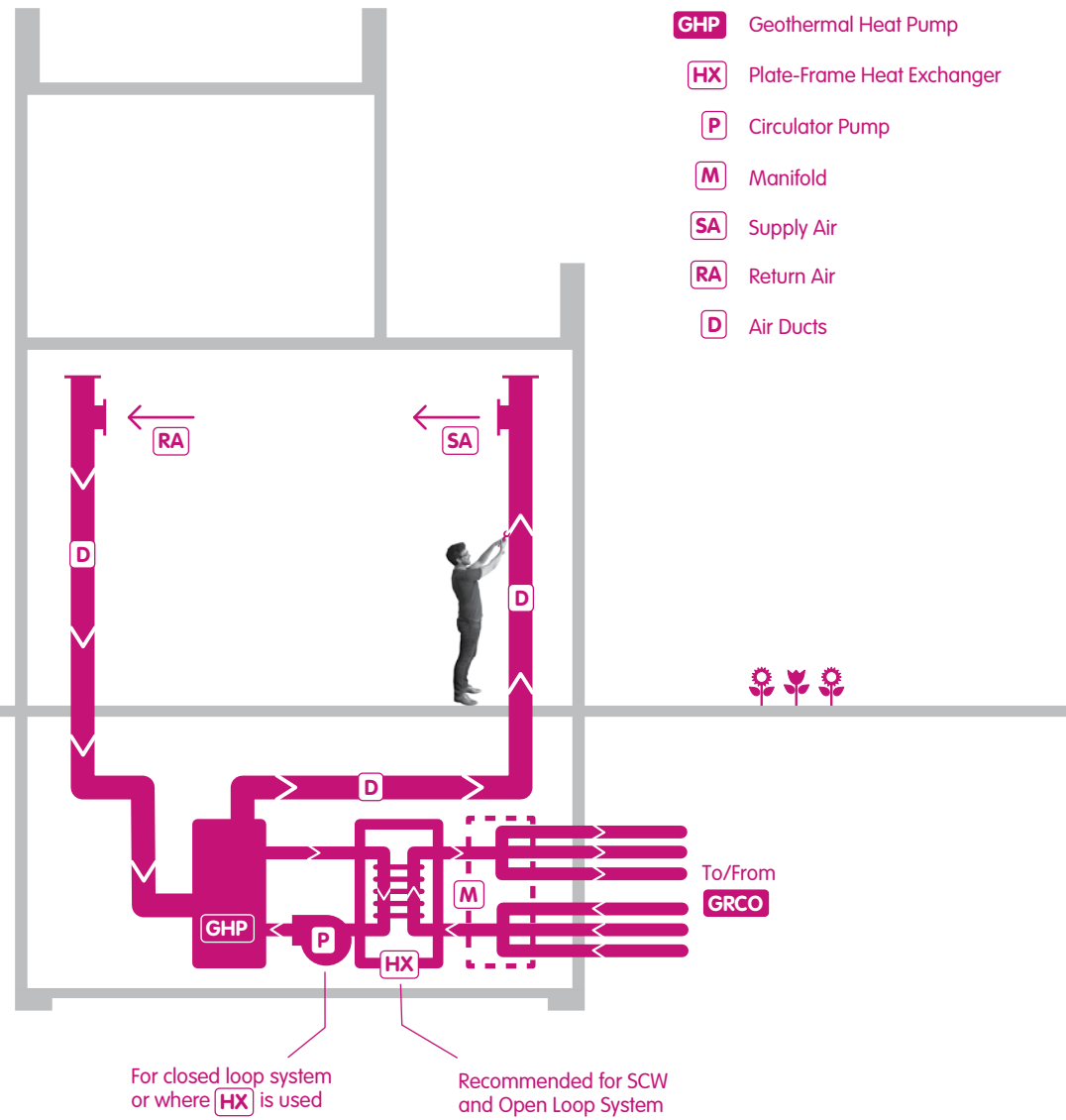
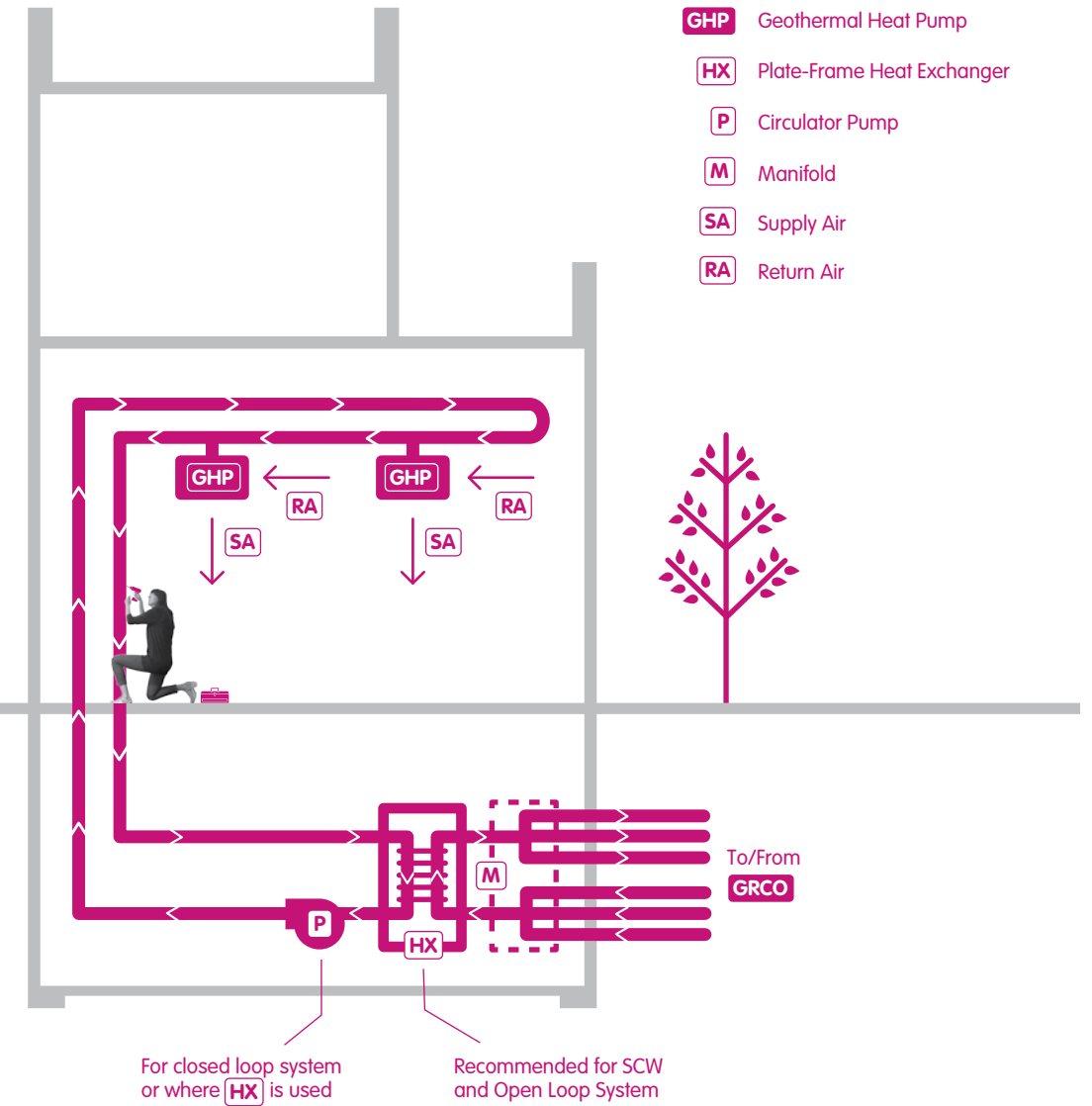


Figure 4.2
Distributed Water-to-Air GHP System



GHP Configurations

Water-to-Water

In water-to-water units, chilled or hot water is generated and distributed to other water-source equipment. Air handling units (AHU) or fan coil units (FCU) as well as heating only elements such as radiant floors or fin tube radiators will use the water for space conditioning.

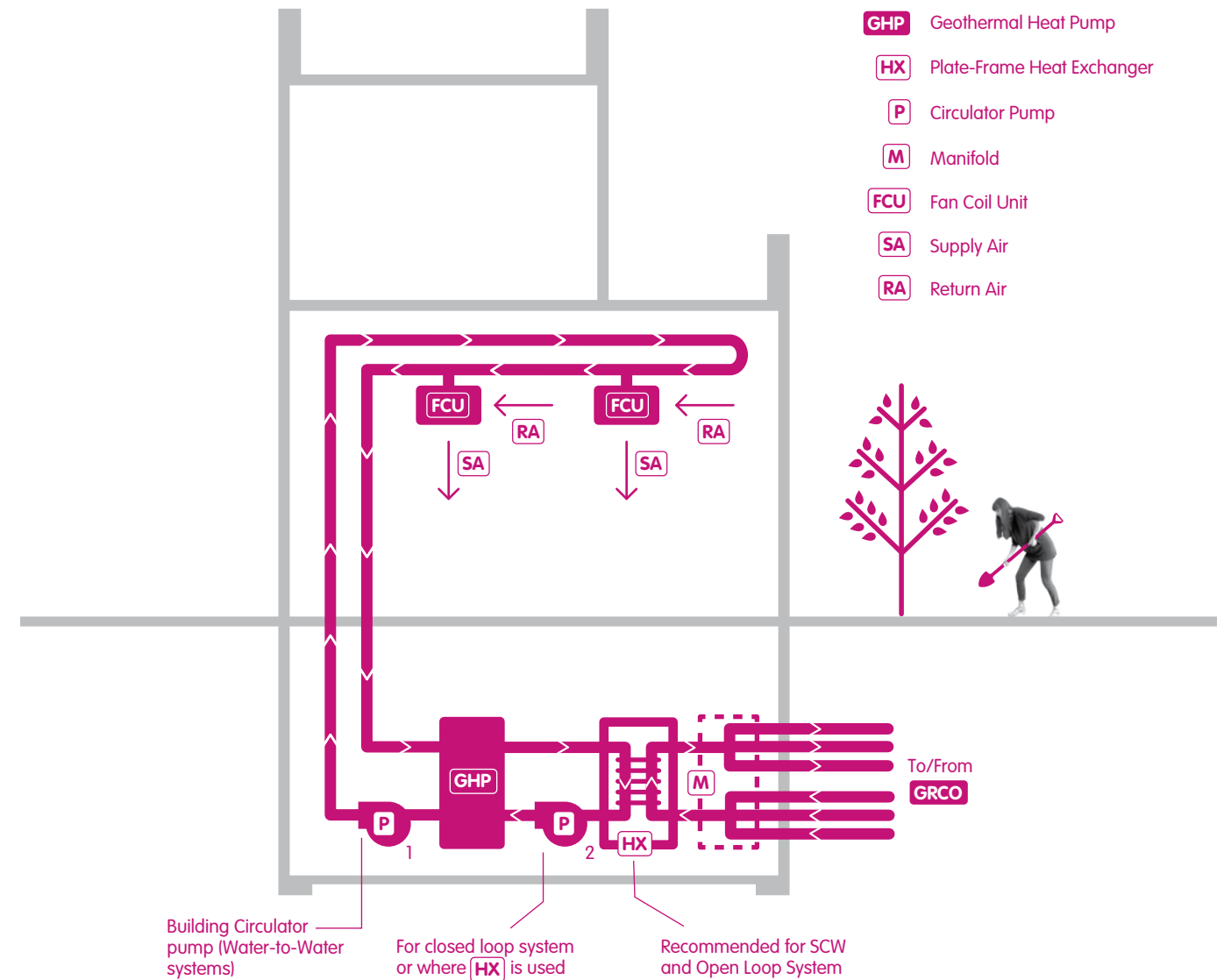
Figure 4.3 shows a simplified centralized water-to-water system. The chilled water temperatures produced are in the conventional 40 to 55 °F range, while temperatures for heating water are approximately 115 to 125 °F. Most heating elements are rated at higher temperatures, therefore these temperatures must be verified with the heating element manufacturer. Overall element sizes will be larger than installations using higher source temperatures.

FCUs are available in a variety of sizes and configurations including ducted and console style units. AHUs distribute conditioned air through ducted distribution systems. Each unit that requires ventilation air is connected to an outside air distribution system, which filters but not necessarily preconditions fresh air.

Water-to-water GHP are usually grouped together in a mechanical space and treated as a conventional heater/chiller plant insofar as the distribution systems are concerned. Unit sizes range from three tons up to 70 tons, but new variations are being developed. Units can be piped so that all units operate together, either in the cooling or the heating mode. However, simultaneous heating and cooling is not possible in this configuration. Multiple unit installations can be piped in groups to allow simultaneous heating and cooling, but this requires a more costly pipe distribution system.

Figure 4.3

Centralized Water-to-Water GHP System



Rooftop Units

Rooftop **GHP**s are similar in all respects to conventional rooftop units, except that the **GRCO** circulation loop is brought to the roof. These units are capable of taking in ventilation air and do not require a separate system. Commercially available rooftop GHPs range from 15 to 30-tons, but manufacturers are introducing newer models with different capacities. Simultaneous heating and cooling from the same rooftop unit is not possible. If multiple zones are required that have different heating and cooling needs, such as interior and perimeter areas, various rooftop units can be used to meet these needs.

Rooftop GHPs should be coordinated with other mechanical equipment to maintain proper spacing and with the roof structure to ensure that loading capacity is not exceeded. In addition, freeze protection may need to be provided for the water loop at the roof.

Split Water-to-Air

The split type water-to-air **GHP** is a water-to-air GHP that separates the condenser/compressor and coil/blower sections. This configuration allows the compressor to be located remotely, which isolates the main source of noise. Although split-type GHPs are similar to water-to-air GHPs, the main disadvantage is that an outside unit requires a larger amount of refrigerant, which creates a potential for leaks and undermines reliability.

Accessory Equipment

GHP systems also benefit from utilizing accessory equipment found in conventional **HVAC** systems. Additional components are incorporated to improve energy efficiency and maintain optimal operation. A **variable frequency drive** **VFD** and a plate frame heat exchanger are commonly used with a GHP unit.

VFDs are commonly used in applications where motors are not required to operate at full or constant capacity. By controlling the frequency of electrical power sent to a motor, a VFD can control the speed at which the motor is running, and by operating at lower speeds, less energy is consumed. HVAC equipment rarely operates at full capacity, therefore VFDs are useful in minimizing energy use. Moreover, there will be variability in building loads even with the most careful load analysis that can be better controlled. VFDs allow heat pumps as well as pump motors to better match actual loads and reduce energy consumption accordingly with finer operation controls.

Heat exchangers **HX** typically exchange thermal energy from one medium to another without direct contact. A common HX used in GHP systems is the plate frame exchanger where ground water or another fluid flows through pipes connected with metal plates. Thermal energy is conducted through multiple metal plates from one fluid to another. HXs are particularly useful where ground water quality is a concern, specifically open loop and **SCW** systems. However, there is an efficiency loss since heat transfer is indirect.

4.4 Ratings and Performance

Similar to the miles per gallon rating for automobiles, **HVAC** equipment is evaluated for energy performance. The Air-conditioning, Heating and Refrigeration Institute **AHRI** along with **ASHRAE** and other standards, produces independent test standards for rating equipment performance. **Energy efficiency ratio** **EER** and **coefficient of performance** **COP** are the two more common measures of energy efficiency and are used to compare different manufacturers or units.

For GHPs, AHRI/ISO Standard 13256–1 and –2 outline specific test conditions, testing procedures and rating of performance for water-to-air and water-to-water units, respectively. Equipment ratings published are available on the AHRI web site. The designer should be aware that equipment rating values are based on assumed site temperatures, load condition, and **GRCO** type, and therefore do not reflect actual installed performance.

ASHRAE Standard 90.1 Energy Standard for Buildings except Low-rise Residential Buildings provides minimum requirements for energy efficient buildings, and is updated every three years to reflect increasing building performance and new technologies. Minimum efficiency requirements for water source heat pumps, which include GHPs, are highlighted in **Table 4.1**. Since **EWT** affects efficiency, **GHP** performance for a closed loop and **SCW** system may vary more than an open loop system. With proper GRCO design, the EWT should be relatively stable throughout the year and remain within the efficient operating range.

System designers and operators should also refer to manufacturers' data specification sheets for heat pump models and auxiliary equipment, which include electrical requirements, fluid connections, and performance data. The information is not only product-specific but use-specific. Performance data usually includes EWT, entering air wet bulb and dry bulb temperatures, fan performance for water-to-air GHPs, total and sensible Btu/h, and water flow. Following manufacturer's specifications is necessary to ensure optimal operation.

Table 4.1

ASHRAE Standard 90.1 2007 Minimum Efficiency Requirements

Equipment Type	Minimum Efficiency	EWT
Water source heat pump (cooling mode), ≤ 17,000 to 135,000 Btu/h	12 EER	86°F
Ground water source (cooling mode), ≤ 135,000 Btu/h	16.2 EER	59°F
Ground source (cooling mode), ≤ 135,000 Btu/h	13.4 EER	77°F
Water source heat pump (heating mode), ≤ 135,000 Btu/h	4.2 COP	68°F
Ground water source (heating mode), ≤ 135,000 Btu/h	3.6 COP	50°F
Ground source (heating mode), ≤ 135,000 Btu/h	3.1 COP	32°F

4.5 Refrigerant Types

Hydrochlorofluorocarbons **HCFC** were commonly used as refrigerants in heat pumps and air conditioners, but are now regulated because of their **ozone depletion potential ODP**. According to the Montreal Protocol, the U.S. will phase out HCFC production and consumption by 2030. Until very recently, refrigerant R-22 was used universally in **GHP** units, but is now considered a transition refrigerant since it has a low ODP value of 0.05. Although this refrigerant is not scheduled for complete phase out in new heat pumps until 2020, most manufacturers now use or are in the process of transitioning to the non-ozone depleting type. The most common of these is R410A, sometimes referred to by the trade names AZ-50, Puron or SUVA 9100. Additional information about R-22 and its replacement refrigerants is available from the U.S. EPA's web site.

4.6 Antifreeze Types

In colder climates, closed loop systems will use an anti-freeze additive during the heating season to prevent the **heat transfer fluid (HTF)** from freezing in the loops. While not common practice for commercial and institutional buildings with a cooling dominant loading, antifreeze may be applicable where the **EWI** will be less than 40 °F because the **GHP** will remove heat and may lower the HTF temperature to below freezing. Various types of antifreeze are available with different properties. The most commonly used antifreeze used in closed loop systems are propylene glycol and methanol (methyl alcohol). At the time of publication, both solutions are accepted by **NYSDEC**, which regulates closed loop systems.

Propylene glycol is a non-toxic, biodegradable fluid that poses no known hazards to the environment, humans or animals, and is commonly used by the food industry. One drawback is that the solution becomes increasingly viscous as the temperature drops below 35 °F, which must be taken into account when designing closed loop systems. On the other hand, methanol is flammable, but relatively small concentrations are used in GHP systems. Nonetheless, its designation as a poison and its flammable properties may be undesirable for some applications.

4.7 Manifold System Design

A manifold system includes components and instruments such as valves, sensors, meters, and gauges as well as the piping that connects the **GRCO** and **GHP**. Both supply and return lines will be manifolded with different components to control and regulate flow in and out of the GRCO. For example, the supply side may have a butterfly valve to control the amount of flow entering while the return side has a balancing valve to maintain circuit pressure. The building operator can monitor and record system conditions manually with these instruments or through the **BMS**, if used.

Manifold components also vary significantly between the three GRCO types, although some are common to more than one. **Table 4.2** lists essential components for each GRCO. Manifold systems can be located in mechanical rooms as shown in **Figure 4.4** or in outdoor or underground vaults. Preassembled manifold systems are also available for smaller installations.

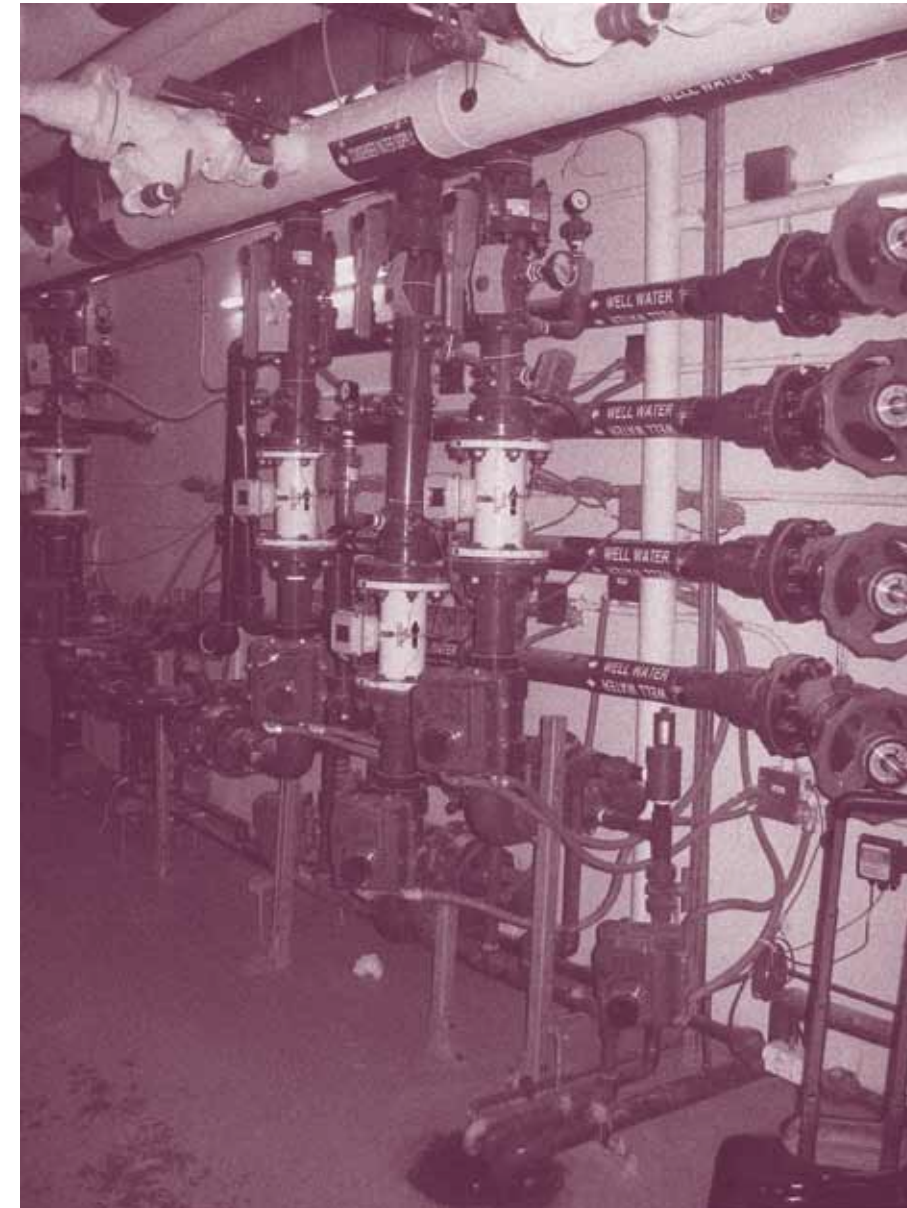
Table 4.2

Typical Manifold Components

Component	Function	Applicable Systems
Differential pressure gauges across heat pumps and HXs	Confirm heat pumps are receiving correct water flow.	All systems
Make-up water tie in	Maintain proper head of HTF.	Closed loop
Pressure and temperature gauges on main supply and return headers	Monitor head loss across loop field and thermal capacity, if necessary. Increase in head loss could indicate restricted flow in HX.	Closed loop, open loop, SCW
Pressure gauges and isolation ball valves on each circuit supply and return line	Monitor flow to/from individual circuits. Isolate a circuit, if necessary.	Closed loop
Circuit Setter on each circuit return line	Balance circuit flows.	Closed loop
Pressure and temperature gauges across the HX	Monitor head loss across HX. Monitor thermal capacity of wells, if necessary.	Open loop, SCW
Flow meter	Verify adequate flow is delivered to meet demand at time of measurement.	Open loop, SCW
Strainer	Filter out particulates from supply water.	Open loop, SCW
Pressure sustaining valve	Maintain back pressure to manifold.	Open loop, SCW
Bleed setup – automated valve, bleed line to disposal, flow meter	Regulate bleed as necessary.	SCW

Figure 4.4

Typical Manifold System



4.8

GRCO Design Considerations

System design and specifications will vary with each **GHP** project. However, certain practices and standards can optimize the **GRCO** and minimize future operational issues. The following items apply to all GRCO types and should be considered by the project team prior to finalizing the design:

Using plastic piping such as PVC and **HDPE** in place of metal piping whenever possible and where code allows. These materials are typically less expensive, easier to install, and not subject to corrosion.

Consult with experienced GRCO contractors regarding installation methods and construction staging.

Evaluate and design to minimize power used in pumping. A motor in a properly designed system should only require 5 to 7.5 hp per 100-ton of cooling.

GRCO Design Considerations

Closed Loop Systems

Because close loop systems typically have less thermal capacity than other GRCOs, the loop field configuration is critical in maximizing available capacity ². Loops at the edge can dissipate heat better than those in the center of the field. As a result, configurations with a greater perimeter to area ratio are more effective in heat exchange with the ground. Moreover, the loop field should be oriented to take advantage of ground water flow, if the site allows. For example, a long narrow loop field should be positioned with the shorter dimension in the direction of ground water flow to benefit from increased heat transfer.

Another issue to consider is heat build-up caused by an imbalanced cooling-dominant load. This is more likely to occur in large loop fields with a high percentage of the loops surrounded by three or four adjacent loops. The problem is compounded when there is insufficient separation between loops, materials have low thermal conductance, or there is minimal ground water flow to disperse the heat. Appropriate spacing based on accurate load analyses will minimize the possibility that this problem will develop.

Some additional techniques for optimizing a closed loop system include:

Using thermally-enhanced grout and minimizing the borehole diameter to reduce grout volume and costs. Also, maximizes heat transfer between loops and surrounding materials.

Where the site allows, increase a minimum spacing to 20 feet on center to minimize long-term heat storage effects. Greater spacing may be required for strongly cooling dominant buildings. The minimum spacing may be as little as 15 feet for strongly heating dominant buildings or if ground water flow is high.

For large buildings or groups of buildings, consider installing individual loop well fields to directly serve separate zones and minimize interior piping cost.

Minimize amount of antifreeze to avoid viscosity effects and reduced performance.

Use simple pump control with a minimum number of control valves.

For a cooling dominant load, the loop field size and installation cost can be reduced by lowering the minimum winter design **EWT** and increasing the maximum summer design EWT. However, **GHP** efficiency will be reduced, affecting the overall system. Also, expanding the EWT range can severely impinge upon the design safety margin. Designing the **GRCO** at the GHP's minimum or maximum EWT limits provides no buffer for weather anomalies. An unusually cold winter or hot summer may place greater actual demand on the loop field than expected. If there is no additional capacity designed, temperatures can be driven beyond the GHP's operating capabilities.

² For more information on closed loop systems, see [Chapter 2 Ground Couplings - Closed Loop](#)

GRCO Design Considerations

Open Loop Systems

Open loop systems typically have higher pumping requirements than other **GRCO** since maintaining proper flow is essential for system performance ³. Required flow rates in most commercial applications range from 1.5 to 3 gpm per ton, although the exact rate is dependent on desired temperature differential between supply and return. In addition, the well pump is a major power-consuming component. Pumping rates must be carefully considered for energy efficiency, and should be addressed during design to minimize future operational costs.

Special precautions and additional design considerations include:

Titanium, stainless steel or other non-metallic materials should be considered for equipment and components that will come in contact with ground water.

Isolating ground water from the **GHP** by using an **HX** is advisable in many cases.

Use of continuous-wrap well screens with V-shaped cross section is advisable. This permits the well to remain clear of sediment and maintain the required flow rates.

³ For more information on open loop systems, see [Chapter 2 Ground Couplings - Open Loop](#)

GRCO Design Considerations

Standing Column Well Systems

SCW systems commonly depend on bleed to maximize performance while minimizing drilling costs ⁴. However, well yield for bleed cannot be established until actual drilling. Therefore, contract documents should include contingencies for deeper wells or even additional wells. Since capacities are difficult to accurately predict, SCWs are a good candidate for a hybrid design.

Special precautions and additional design considerations include:

As part of design, suitable computer modeling and calculations should be run using an accurate load profile to verify the number and minimum spacing between wells.

Schedule bleed cycles in the sequence of operation and allow periods for ground water levels to recover.

Water quality and sediment control can often be a problem. Sediment separators should be included in the well water system. Water quality testing and analysis should be performed. Consider using plate frame heat exchangers between well water and the **GHP**.

Use materials compatible with the well water chemistry determined by laboratory analysis.

Incorporate measures to minimize air intrusion into the system. Air separators and vents must be used.

⁴ For more information on open loop systems, see [Chapter 2 Ground Couplings - Open Loop](#)

Include safety controls such as well water level sensors and/or flow switches to protect well pumps from running dry.

Where multiple wells are manifolded together, flow rates must be properly balanced to avoid pumping water from one well to the other. Consider using automatic/self balancing valves.

Consider well pump controls for multiple well systems. Variable speed pump controls can result in flow imbalance between wells. A proper control strategy along with automatic well isolation valves may be just as effective.

4.9 Hybrid Systems

Most building HVAC systems operate below the design peak load for most of the year despite being sized to meet the greatest annual demand. Some equipment can operate efficiently under partial loading conditions. However, since GRCO are typically sized to meet the peak load, there is a substantial installation cost that is not necessarily recovered during operation. Integrating supplementary equipment such as a cooling tower or boiler can help reduce the GRCO size required while maintaining energy benefits of a GHP system. As a result of reduced construction costs and improved operating efficiency, hybrid systems are growing in popularity.

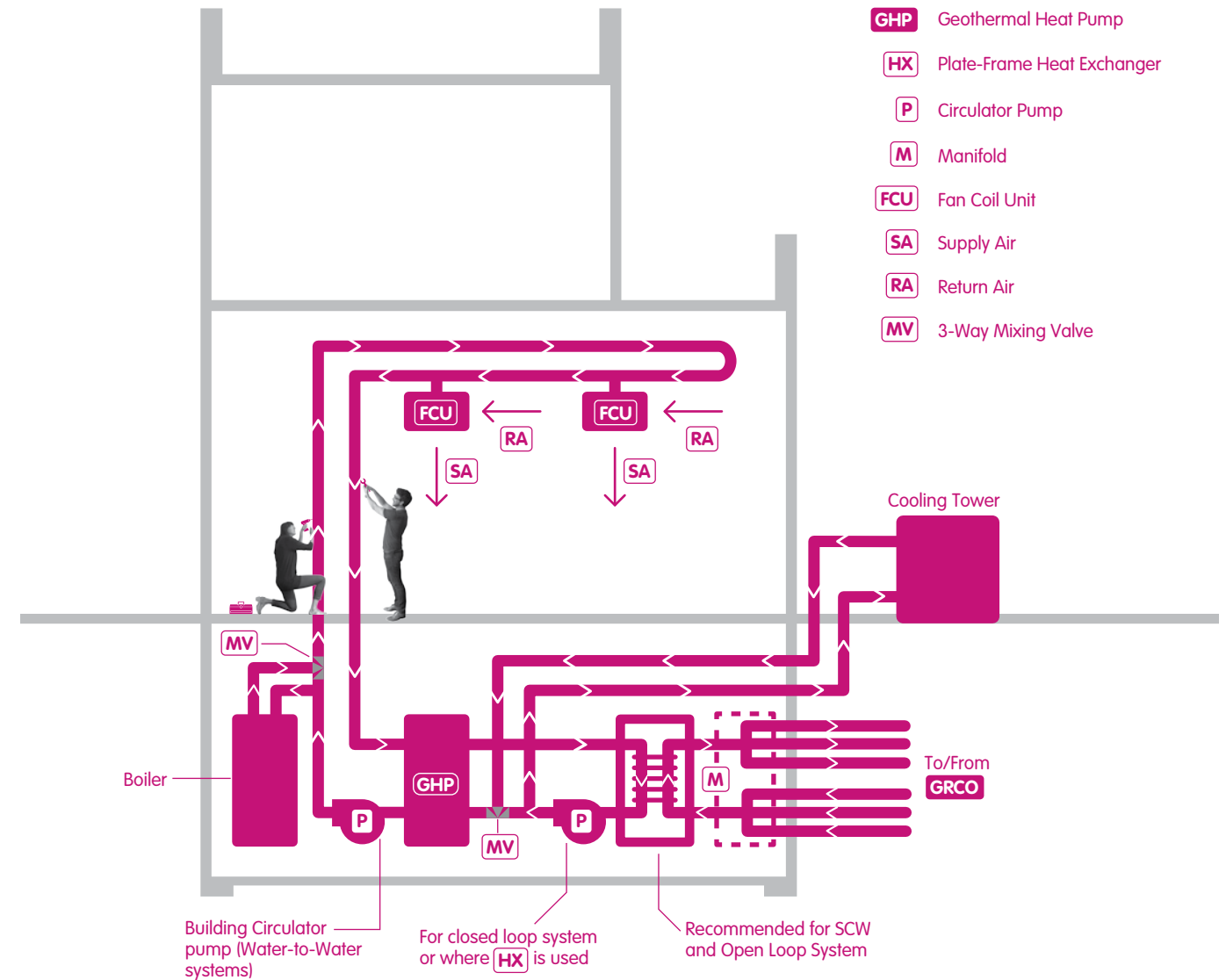
A hybrid system can also be used to balance the overall load imposed on the ground in addition to reducing the number of wells or loops required. Determining the optimal base load for the GRCO will require an energy model and analysis along with a life cycle cost analysis for the various base loading options. Energy modeling programs such as DOE2, TRACE and BLAST can be used.

Additional benefits of a hybrid system include:

- Providing more reliable systems.
- Providing a buffer against possible inaccuracies in design building load or thermal capacity estimates of the ground.
- Increasing the viability of using geothermal by reducing the land area required.

Figure 4.5 illustrates an example of a hybrid system with boiler and cooling tower. Hybrid systems do introduce another level of complexity and control with added equipment, but benefits may outweigh the additional concerns. Controls should be properly adjusted to insure that the supplemental equipment is used only when necessary, and that the GHP system is not disconnected.

Figure 4.5
Simplified Illustration of a Hybrid GHP System with Boiler and Cooling Tower



4.10

System Redundancy

Redundancy and back-up can be built into a **GHP** system to avoid serious system downtime during maintenance or component failure. Different strategies and equipment will be necessary for each of the **GRCO** types.

Closed Loop System

Dual circulator pumps should be installed for fluid circulation, one primary and one back-up. Some building owners elect to install extra capacity in the loop field in case one or more loops fail. While unlikely, a leak may occur and without knowing the location within the circuit, it may not be possible or cost-effective to locate or repair. If additional capacity is provided, the affected circuit can be isolated from the system and abandoned without losing system performance. Other situations may include excavation work in or near the loop field area that damages piping. If the piping is unsalvageable, the circuit can be isolated and abandoned.

Open Loop System

Submersible well pumps are sized to include additional pumping capacity to meet the required peak flow. With proper monitoring, pump issues can be detected early enough to schedule maintenance before failures. While a new well pump can normally be installed within two days, pump failures are not always predictable. One option to consider is to have a spare pump available to avoid any wait time for the delivery of a new one.

Standing Column Well System

Similar **O&M** issues for open loop systems apply to SCWs, although downtime for a **SCW** represents lost capacity. To provide full system redundancy, installing more wells for additional capacity is required. Alternately, the system bleed rate can be temporarily increased, but at the risk of increasing drawdowns and reducing flow rates from the operating wells.

Supplemental Heating

Although a GRCO may already have additional capacity included, incorporating auxiliary heating equipment should be considered early in design for projects where heating is critical. Because the supplemental heating system will only operate during emergencies such as **GRCO** service disruption or extreme winter conditions, it should be carefully incorporated and sized to meet the minimum heat load to maintain building operation. Otherwise, the supplemental system becomes the primary system and the initial capital costs will be much greater.



5.0 List of Abbreviations

Cx

Commissioning

GHP

Geothermal
Heat Pump

GRCO

Ground Coupling

HTF

Heat Transfer Fluid

HVAC

Heating, Ventilation,
and Air Conditioning

HX

Heat Exchanger

SCW

Standing Column Well

5.1 Construction

In many respects, construction during a **GHP** system project is fairly similar to a conventional **HVAC** project, especially inside the building. However, the project team will face issues that are distinct to **GRCO** installation. Greater attention and coordination will be required for regulatory requirements, drilling and installation, and initial system start-up. Qualified and experienced contractors along with continued design team involvement are necessary to manage the entire process.

Contracting Considerations

GRCO installation may present new types of work for some projects, and the GC or CM will need to closely coordinate activities such as drilling and GHP mechanical connection with corresponding trades. Although a single contractor who is responsible for both the **GRCO** and **GHP** installation is ideal, the arrangement may not always be possible. Project teams should also consider including the **GRCO** installation under the GC's contract to minimize conflicts with exterior work.

5.2 Contractor Training and Certification

Contractors should have related certifications and training that is supplemented with **GHP** project experience. While the majority of training addresses **GRCO** construction methods, most installation issues often result from improper connections between the **GRCO** and the **GHP**. Contractors should be equally trained in the installation and connection of all components. Trade organizations, such as the [International Ground Source Heat Pump Association \(IGSHPA\)](#) and the [National Ground Water Association \(NGWA\)](#), offer training and certification for GHP systems.

GRCO Installation

Each **GRCO** type requires different specialized trade skills, and are typically represented by two major segments of the drilling industry. Drilling for open loop and standing column wells is very similar to conventional water well drilling. All drillers should be licensed and possess the appropriate equipment to drill and install casing at a project site. Drilling companies working in New York State must be registered with [New York State Department of Environmental Conservation \(NYSDEC\)](#) and New York State law requires a **NGWA** exam certified individual to provide on-site supervision during water well drilling activities. Qualified drillers may also be members of the **NGWA** with various levels of certification.

Closed loop drillers and installers come from many different areas of the drilling industry, and may include geotechnical and environmental drilling contractors in addition to water well contractors. All contractors should be certified by **IGSHPA** and have pipe fusion certification from one of the primary **HDPE** pipe manufacturers. While this particular certification program focuses on closed loop technology, the instruction also includes water well methods and proper design techniques. **NGWA** has also recently developed a training and certification program for closed loop installers.

GHPs and Distribution

While contractors are generally familiar with water source heat pumps and building distribution, a **GHP** system requires knowledge and experience with specific interfaces for proper installation. Industry-sponsored training programs for GHPs and distribution are provided by most of the large heat pump manufacturers. Contacts can be obtained from the [Air Conditioning, Heating and Refrigeration Institute \(AHRI\)](#). Other national trade and manufacturer training programs for conventional water source heat pump systems have also developed geothermal training programs, including **ASHRAE** and the [Air Conditioning Contractors Association \(ACCA\)](#). These organizations have the structure and resources to integrate local professional training and informational seminars for GHP systems.

5.3 Construction Logistics

GRCO installation must be closely coordinated with other site work, especially earthworks and utility installation. In the case of a closed loop system where the loop field requires a large area, drilling effectively dominates the site for a significant period of time. Additional area may also be required for material storage such as loop coils, grout, and sand. **Figure 5.1** is a photograph of a closed loop project during construction. Note that the piping is already on-site along with soil stockpiles and debris from drilling and other site work.

Drilling and loop installation may require up to two days before moving to the next well location, although multiple drill rigs may operate simultaneously. A system that requires approximately 40 loops may take up to 80 days to complete using a single rig, or 40 days with two. After loop installation, a trenching contractor will install horizontal piping that connects the loops into circuits. The circuits are then routed to either the building or to a manifold in an exterior vault. Horizontal piping and vault installation can take an additional two to three weeks. Photographs in **Figure 5.2** show vault installation and pressure testing of the circuit.

Open loop wells can each take several days to install, while a **SCW** take two to four weeks, depending on site constraints and drift monitoring, if required. Although drilling operations in both systems are similar, SCWs may require more space than open loop wells because a larger rig may be necessary to penetrate bedrock and drill deeper depths. Support vehicles, auxiliary

compressor and booster, storage area for steel casing and drill rods, and dumpsters to contain drill cuttings and ground water also increase the amount of space needed during drilling. **Figure 5.3** shows drilling for a SCW on a confined, narrow site.

Horizontal piping for all GRCOs must be coordinated with the installation of site utilities and any underground structures. Open loop wells and SCWs can be drilled first, and the horizontal piping installed at a later time to accommodate other utility installation work. In this case, the top of the well should be temporarily capped, clearly identified and protected from work performed by other trades. This practice is acceptable since there are relatively few boreholes for these systems and locations are usually distributed throughout the site. In contrast, the horizontal piping in a closed loop system should be installed immediately after loop installation or while the final loops are being drilled, because loops are closer to each other, extend over a large area, and are more susceptible to damage.

GRCO construction is independent of the in-building portion and can be completed at any time. However, the drilling and mechanical contractors must complete their respective portions and sign off on their installation before the two are connected.

Figure 5.1

Construction Site: Closed Loop System

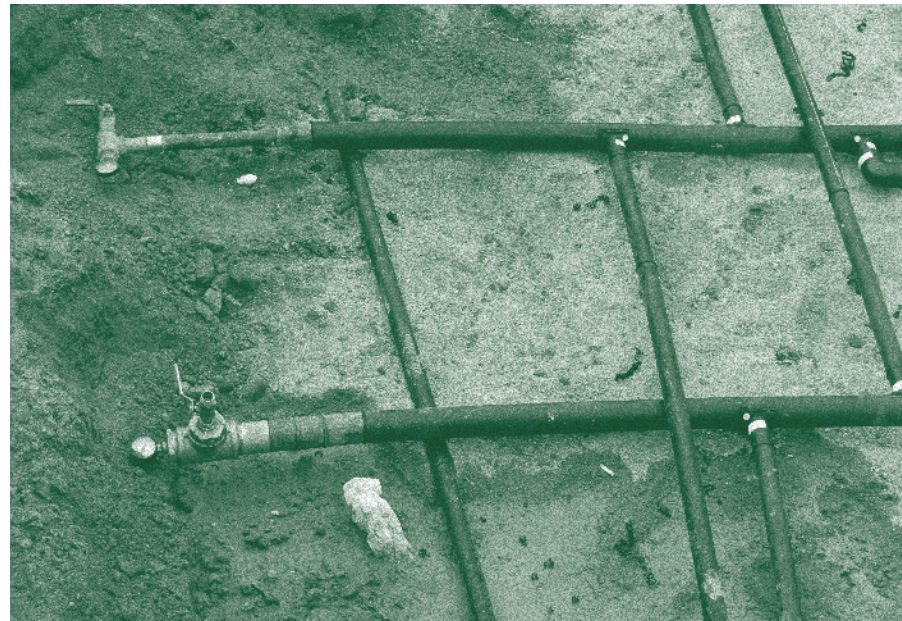


Figure 5.2

Piping Installation: Closed Loop System



Vault Installation



Pressure Testing of Circuit

Figure 5.3

Drilling Operation: Standing Column Well



5.4 Regulatory Requirements

Permits and notifications are required by various regulatory agencies for **GHP** systems ¹. Federal, state and local authorities will each regulate different aspects of the drilling, installation, and operation. Requirements also vary depending on the type of system, project location, depth of wells and other considerations. The following table summarizes the primary agencies involved with GHP systems at the time of publication. ²

Agency Name	Permit or Approval Required	Agency Name	Permit or Approval Required
USEPA	USEPA authorizes “by rule” the use of geothermal wells as Class V injection wells under the UIC Program.	NYCDEP	A Sewer Discharge Permit is required to dispose of ground water generated during drilling/ well installation to a city sewer.
	A Mining Permit is required for drilling below a depth of 500 ft.		Approval is required if drilling within 500 ft of city water tunnels.
NYSDEC	A Long Island Well Permit is required for wells with permanent pumps rated at ≥45 gpm (total for site).	NYCDOH	A Type 33 Permit is required to use well water for non-potable purposes.
NYCDOT	Revocable Consent Agreement required to drill and install wells and piping beneath city sidewalks.	NYCT	Notification and approval are required if drilling within 200 ft. of any transportation structure, including tunnels, substations, fan buildings, etc.
	Street Opening Permit required for temporary closure of sidewalk or street during construction.	LIRR	
		Metro North	
		PANYNJ	

Regulatory Requirements

U.S. Environmental Protection Agency

Under the Underground Injection Control program, administered by the **U.S. Environmental Protection Agency** (**USEPA**), **SCW** and open loop diffusion wells are considered beneficial use Class V injection wells. The USEPA can, therefore, authorize operation of a geothermal well “by rule” pursuant to the regulations. Specific inventory information on the wells and the site’s hydrogeologic conditions must be submitted to USEPA prior to construction. However, construction may proceed before final approval. Vertical closed loop and open loop system supply wells are exempt. The review and approval period is approximately four to six weeks.

New York State Department of Environmental Conservation

Division of Mineral Resources

The **NYSDEC** Division of Mineral Resources requires a “mining” permit for any drilling activity below a depth of 500 feet. However, these permits have historically been issued for standing column wells. According to the Division of Mineral Resources, there have been no applications made for open loop or closed loop systems to date. Well locations, depth, use, casing material, cementing procedures, drilling fluid and cuttings disposal methods must be submitted with the permit application. In addition, the surface casing must extend a minimum of 75 feet beyond the deepest fresh water zone encountered or into competent bedrock, whichever is deeper.

The Division of Mineral Resources also requires that the wells do not drift beneath adjacent properties for which the applicant has not received permission from the property owner. To demonstrate compliance, angular deviation and directional surveys must be performed at 100 ft. intervals during drilling using a gyroscope or other approved method. If the borehole drifts near the property boundary of an adjoining site for which the building owner has not received approval, drilling must stop, and the well must be completed at that depth. Any borehole intersecting such a property boundary must be abandoned and sealed.

The Division of Mineral Resources will consult with the New York State **Office of Parks, Recreation and Historic Preservation** on whether the location of a well is within a state-listed historic area in which case permission is

¹ For more information, see **Table D.2 Regulatory Requirements for GHP Systems**
² Additional information on each regulatory requirement by agency is provided in **Appendix C**. For a summary of requirements, see **Appendix D**.

Regulatory Requirements

required. NYS Parks reviews the project to ensure that the installation of wells will not have a negative impact upon cultural resources. If approval from New York City agencies is required, the Division of Mineral Resources will require documentation of approvals as part of the permit application.

The Division of Mineral Resources review and approval takes approximately six to eight weeks. If separate approval by NYS Parks or any city agencies is required, approval may take longer. A filing fee for a 1,500 feet **SCW** is approximately \$670*, and a \$2,500 security must be paid and put into escrow by the Division of Mineral Resources in case a building owner defaults, and the well must be abandoned.

Division of Water

NYSDEC Division of Water regulates wells less than 500 feet deep. Drillers and pump installers are required to be registered and certified for open loop or **SCW** systems. The Division of Water also requires pre-notification and well completion reports to be filed for open loop or SCW systems. Closed loop systems are not required to follow these regulations.

A Long Island Well Permit is required from the Division of Water to install and operate an open loop or SCW system in Brooklyn and Queens with a total pumping capacity greater than 45 gpm. The permit application is filed with the Division of Water Region 2 office in Long Island City, and includes a joint application for permitting with the Army Corps of Engineers, a Short Environmental Assessment Form (EAF), and a Long Island Well Permit form. If the return water is discharged to a surface water body, a State Pollutant Discharge Elimination System (SPDES) permit is also

required. The review and approval period is approximately six to eight weeks.

New York City Department of Transportation

Revocable Consent

The building owner must enter into a Revocable Consent Agreement (RCA) with the **New York City Department of Transportation** **NYCDOT** Bureau of Franchises to construct permanent wells or loops through city side-walks. The agreement allows the city to reclaim use of the land at some future time in which case the wells may have to be taken out of service and abandoned. The building owner should meet with NYCDOT regarding the application procedure and any special requirements that may be required prior to submitting the application.

There is no initial filing fee, however annual fees apply for wells and possibly for buried connector piping installed beneath city sidewalks. The fee is \$3,000 per well, unless the building is a city-designated landmark or non-landmark building located in a historic district. The annual fee is \$25* per well for historic buildings. A minimum time frame of four months is required from initial NYCDOT submission to receive the RCA. However, the project team should allow five to six months in their schedule.

NYCDOT requires angular deviation and directional surveys per **NYCDEP** requirements if drilling within 500 feet of a water tunnel. Wells located greater than 500 feet of a water tunnel, and not under NYCDEP jurisdiction, requires deviation surveys to 850 feet at 100 feet intervals as part of the RCA.

Regulatory Requirements

Sidewalk/Street Closings

Since drilling can occupy large areas for a rig and other necessary equipment, projects with limited outdoor spaces may need to use the adjoining sidewalk and street lane as a work area or for equipment and material storage. A sidewalk and street lane closing permit may be required from the NYCDOT Office of Construction Mitigation and Coordination. There is no filing fee and the permitting process takes approximately one to two months.

New York City Department of Environmental Protection

Water Tunnel Clearance

NYCDEP has issued riders to address geothermal wells located between 200 and 500 feet of any city water supply facility, specifically water tunnels, shafts or appurtenant facilities. Drilling is prohibited within 200 feet of the centerline of a water tunnel, and proposed drilling locations located within 500 feet from water tunnels are to be identified.

NYCDEP will review a site plan with plotted well locations and make a determination of the actual distance of wells to a water tunnel. Submissions of angular deviation and directional surveys are required with depth intervals, depending on the distance from a tunnel. NYCDEP will usually respond to a request for determination within a few weeks.

Sewer Discharge Permit

NYCDEP issues permits for temporary disposal of drilling fluids and ground water to the city sewers generated during construction. Approval may be necessary from two separate NYCDEP divisions depending on the daily discharge amount, one for chemical analysis of water from the **Division of Pollution Control and Monitoring**, and the other from the **Division of Permitting and Connections** for daily discharge volume.

A sample of the proposed wastewater must be analyzed by a NYS-certified laboratory and the results submitted with the application. The Division of Pollution Control and Monitoring will specify the chemical parameters, analytical methods, and detection limits. Treatment of the water before disposal into the sewer may become necessary if any of the compounds exceed regulatory limits. If so, a treatment system must be proposed in the application, including specifications, engineering calculations and other details. At a minimum, pre-treatment to allow sediment to settle out before discharge is required.

There is no filing fee, but a discharge fee per gallon based on the estimated volume will apply. Normal turn-around time for approval from the Division of Pollution Control and Monitoring is two to four weeks, although approval from the Division of Permitting and Connections may take longer. Upon approval from DPCM and DPC, the fee is paid to the **Borough Office of the Bureau of Customer Services**, which then issues a discharge permit.

* Fees are subject to change

Regulatory Requirements

New York City Department of Health

Under Article 141 of the New York City Health Code, the [New York City Department of Health \(NYCDOH\)](#) permit Type 33 is required if well water is used for purposes other than potable supply, such as an open loop supply well. An [SCW](#) that recycles bleed water for other uses, such as irrigation, water fountains or grey water also requires a permit.

Form 314c Application for Permit and form PHE 98 Well Water Questionnaire must be submitted. A site plan indicating possible pollution sources up to 200 feet of the well and a completed well log from the contractor are also required. The Bureau of Public Health Engineering will perform an inspection and collect a water sample for their analysis. A well may not be used until a permit has been issued by NYCDOH. The initial fee for this permit is \$300* and must be renewed each year. An annual renewal fee is \$15* after the first year and an annual bacteriological sample from a New York State Health Department certified laboratory is also required for renewal.

Department of Parks and Recreation

Trimming, removal, or replacement of city-owned trees in the sidewalk may at times be necessary, and will require coordination with and approval from NYC Department of Parks and Recreation.

Public Transportation Agencies

The [Metropolitan Transit Authority \(MTA\)](#), which includes NYCTA, LIRR and Metro North, and the [Port Authority of New York and New Jersey \(PANYNJ\)](#) must be informed of planned geothermal drilling located within a distance of 200 feet from their transportation structures, including tunnels, substations, ventilation buildings, and stations. If MTA review and approval is required, the [New York City Department of Buildings \(NYCDOB\)](#) requires that MTA approval be noted in the drawings for building permit applications.

5.5 GRCO Monitoring and Coordination

Potential construction issues on [GHP](#) system projects range from drilling drift to neighborhood noise impact. Although some issues cannot be avoided, most can be managed with proper planning and foresight. Monitoring and supervision is particularly necessary during [GRCO](#) installation. In addition to surveys and logs for regulatory purposes, regular monitoring of drilling and installation will allow the project team to address problems earlier in construction.

Drift

Despite best efforts during drilling, some amount of deviation from plumb, or drift, will occur in a vertical borehole. Drift is more noticeable in [SCW](#) where the drilling depth is much greater and ensuring plumb is much more difficult. Most SCW drillers working in the city are equipped to control drift. However, drillers should be required to demonstrate they have control measures in place to drill straight holes as part of their qualifications for a project. Controls include laser guided drilling and slower speeds to better track any deviation. Drift along property lines may exacerbate the issue of thermal rights in a tight urban environment. Therefore, drift occurring beneath adjoining sites should be referred to an appropriate attorney.

Vibration

Ground vibrations that occur while drilling may be subject to additional monitoring. According to the NYC Department of Buildings Technical Policy and Procedure Notice TPPN #10/88, ground vibration and settlement monitoring are required during specific construction activities within 90 feet of a building that is a designated NYC Landmark or located within a historic district.

Vibration (peak particle velocity) measurements must not exceed 0.5 inches/second using a portable seismograph adjacent to or within a historic structure. Vertical or horizontal building movement cannot exceed 0.25 inches, and must be verified at least twice per week by a licensed land surveyor. TPPN #10/88 also requires weekly photographs during construction of “telltales”, which are monitoring devices placed over existing cracks in the historic building.

Although TPPN #10/88 does not strictly pertain to drilling for geothermal wells, monitoring along with pre and post-construction surveys should be considered as a precautionary measure to protect against future claims. Additionally, the [MTA](#) and [PANYNJ](#) may require vibration monitoring within their tunnels for drilling within specified distances.

* Fees are subject to change

GRCO installation will require additional coordination to minimize further disturbances during construction to an existing facility or neighbors. Items listed below should be evaluated prior to the start of construction to ensure that an appropriate plan of action is in place.

All GHP Projects

Sidewalk drilling operations can obstruct building entrances and access to neighboring properties for a period of time. Alternate entrances and accessible routes may be required for the duration of construction.

Drilling operations can create wet and muddy site conditions. Methods to contain generated drilling fluids and ground water should be employed, such as lined dumpsters, hay bales and plastic or other liner material.

Drill rig masts may be as high as 35 feet, potentially requiring trimming, removal, and/or replacement of city-owned trees in the sidewalk or the project site.

The contractor should implement noise mitigation measures to the extent feasible to reduce the problem and comply with the city's Noise Code, and Mechanical Code. ³

Closed Loop Systems

The loop field area will be disturbed by concentrated drilling activities and trenching, and must be restored after installation.

Construction duration may be long compared to an open loop or **SCW** project. However, using more than one rig can accelerate construction time.

Open Loop Systems

Well development and pumping tests involve pumping and discharging large volumes of ground water to the city sewer system for extended periods of time, from several days for well development to a continuous 72-hour aquifer pumping test. Plans for alternate discharge locations may sometimes be necessary.

Standing Column Wells

Auxiliary compressors and boosters may be required, and additional mitigation may be necessary to address increased drilling noise levels.

Ground water is blown to the surface from the well borehole during drilling, and at times cannot be effectively contained. Back up containment may be necessary.

Various monitoring activities in the neighborhood for vibrations, ground settlement and drift, may be highly visible and trigger neighborhood inquiries.

5.6 GRCO Best Practices

Activities listed below are recommended practices for **GRCO** installation and should be incorporated into the construction schedule.

All GHP Projects

Initiate discussions at least six months before drilling is scheduled to start with long lead-time agencies including **NYCDOT** for the RCA application, and **MTA** and **PANYNJ** on drilling approval requests.

A professional geologist/hydrogeologist or geotechnical engineer should be retained to document subsurface conditions, observe construction methods, and assist with addressing field modifications and contingency measures, if required.

Closed Loop Systems

The loop piping construction should be inspected periodically by the geothermal engineer or a qualified project team member to ensure that the work complies with the construction documents and best industry practices, specifically borehole grouting, proper heat-fuse welding of pipe joints, flushing and air removal.

Open Loop Systems

Conduct an aquifer pumping test to determine sustainable ground water yield.

Conduct borehole geophysical logging together with geologist's drilling log and sieve analysis to determine location of well screen.

Before well construction, all drilling equipment and well construction materials should be thoroughly disinfected or shipped in a sealed, disinfected condition to prevent introducing bacteria into the well. All equipment and materials should also be disinfected prior to drilling additional wells to prevent cross contamination.

Standing Column Wells

Conduct a pre-conditions survey of surrounding buildings and structures in the immediate vicinity of all wells, such as subway tunnels.

Upon drilling completion, a representative number of boreholes should be logged using a downhole video camera in addition to downhole geophysical logging, such as acoustic logs to establish baseline conditions. Videos and logs can therefore be used in the future for troubleshooting well performance.

Sustainable yield from the well may be significantly less than initial high yields observed during drilling, and should only be determined by conducting an aquifer pumping test.

Conduct a pumping test following well installation to verify the well yield relative to design bleed assumptions.

If ground water quality analysis was not previously performed, sample and analyze the first ground water encountered during drilling to verify selection of construction materials and whether or not a **HX** is necessary.

All drilling equipment and well construction materials should be thoroughly disinfected before introducing into the borehole.

³ Local Law 113 of 2005 amended New York City's noise code to enforce limits on a variety of noise sources including construction.

5.7 System Start-up and Balancing

After construction is completed and equipment is installed, system start-up and balancing will typically be performed by the mechanical contractor. Initial start-up will follow manufacturer's recommended procedures to confirm proper installation and operation. Balancing ensures that the system is adjusted and set to function as designed. The entire process should be witnessed by the commissioning agent, if part of the project team.

GRCO

The first step in start-up is to flush out the **GRCO**, and connecting lines to the **GHP** unit should not be coupled before doing so. Flushing will remove any debris and air that may be trapped in piping from the loops or wells. If ground water or other **HTF** is circulated through the unit without flushing the piping first, the GHP unit may be damaged. Contractors should carefully check for any visible signs of water leakage before digging or boring down any coupling locations. If visible leakage is found, the contractor should locate the source and should retest after the problem is corrected. Flushing should continue until discharged HTF is clear and clean. New HTF will refill the piping, and the contractor will test pH levels, which should be between 7.5 and 8.5. Antifreeze may also be added at this point, if applicable.

When the GRCO has been completely flushed and leak tested, the appropriate supply and return connections are made to the GHP unit. The circulator pump should circulate the HTF through the entire system for five minutes before operating the heat pump. After the water is allowed to circulate, the contractor will adjust the flow rate and power up the GHP unit. The flow rate should be within the GHP manufacturer's specified operating range, and at minimum, not less than the minimum rate required. If the flow is less than previously calculated,

the contractor should review system calculations. Trapped air or a restriction in the HTF circuit is most likely present if calculations are correct.

In addition to flush out and flow rate adjustments, each GRCO type will have its own specific start-up requirements.

Closed Loop: In addition to removing particulates and trapped air in piping through flush out, the contractor will also monitor the pressure and temperature on both the supply and return sides. Significant pressure and temperature differentials indicate potential leaks or the need for flow rate adjustments.

Open Loop: If wells are drilled in advance of system start-up, supply wells should be pumped and tested for contaminants. If contaminants are present, well redevelopment may be necessary if further flushing does not produce clear and clean ground water.

SCW: Similar to open loop start-up, ground water should be tested for potential contaminants. For systems with a single SCW, startup should be relatively simple, but when multiple SCWs are used in parallel, flow rates from and to each well must be carefully balanced so as to avoid pumping water from one well to another. Variable speed pumps and staging of wells must also be checked carefully to avoid well flow rate imbalances. Safety controls such as flow switches should be provided to avoid operating well pumps with a dry well.

System Start-up and Balancing

GHP

The refrigerant system should be checked for tightness, leaks, correct refrigerant charge and proper operation of all refrigerant loop components. Refrigerant charge should be checked at the following temperatures and pressures:

Outdoor entering dry bulb temperature

Indoor entering dry and wet bulb temperatures

Suction line temperature at outdoor unit

Low side pressure

High side pressure

The contractor should also verify that all electrical connections are correct and tight. **GHP** voltage and amperage should be measured and compared with the range specified by the manufacturer. Fuses and breakers should also be verified that they are the proper size and type.

The contractor should clean the coil during start-up and confirm that it is in the correct configuration. If the coil is dirty, it should be cleaned using a non-acidic coil cleaner and then thoroughly rinsed. Clean filters should be provided and replaced at scheduled intervals throughout the year and at each servicing. In addition, the drain pan and trap should be inspected for dirt and sediment, especially following construction. The contractor should ensure the pan, trap and drain line are thoroughly cleaned.

As part of start-up, the contractor should inspect the ductwork system and thermostats. Ductwork should have balancing dampers installed on supply and return branches, tight joints and proper installation. Ductwork in unconditioned spaces should be insulated. The contractor should also confirm that the thermostat installation is unaffected by extraneous heat and cold. Wiring connections should be verified and inspected for any damage.

5.8 Commissioning

Commissioning Cx is a systematic process, managed by a Commissioning Authority **CxA**, to verify that a project is designed, constructed, and operated as intended. It is a form of quality control to ensure for the owner, architect, design engineer, contractors, and operations staff that systems and equipment function correctly upon installation, and that the project is documented and turned over properly. Cx confirms the integration of all project expectations, from planning to acceptance, through design review, field inspection and functional performance testing, oversight of operator training, and verification of record documentation. Benefits of commissioning include reduced energy usage, lower operating costs, fewer contractor callbacks, improved building documentation, and increased occupant productivity as a result of a better workplace environment.

Geothermal Commissioning

Unique to **GHP** systems is a two-component **Cx** review process of above and below ground systems. The selected **CxA** must therefore have experience in the particular **GRCO** type proposed as well as with associated above ground building systems. The CxA may coordinate input from other consultants as appropriate, including geologists, hydrologists, geotechnical engineers, and geothermal consultants.

There are several established Cx tasks that should be performed throughout the lifecycle of a **GHP** project to verify that expectations are met or exceeded. See accompanying table and the respective System Diagram for Cx considerations for each geothermal system:

Closed Loop Well - illustration pg. 43, **Figure 2.3.1**

Open Loop Well - illustration pg. 49, **Figure 2.3.5**

Standing Column Well System - illustration pg. 55, **Figure 2.3.8**

The Cx process can be customized to include some or all of these listed tasks or amended with additional items, depending on the owner's needs. Ideally, GHP Cx should be performed during design, construction, and turnover to realize the full benefits of the process.

Routine Maintenance/Continuous Commissioning

In addition to the initial **Cx** tasks discussed above, it is recommended that a Continuous Cx program be created specifically for each **GHP** project and adopted to verify that proper performance is maintained. Below are some items to consider when developing this program:

Commissioning

All GHP Systems

Track and document the supply and return temperatures during various heating and cooling load conditions to verify system performance.

Check system performance in both heating and cooling seasons.

If a Building Management System (BMS) interface is available, set up trend logs in the BMS to perform this monitoring and reporting. Review information monthly at a minimum.

Closed Loop Systems

Regularly test loop piping.

Document system temperatures and pressures.

Perform water sampling of closed loop fluid yearly.

Open Loop Systems

Consider performing a yearly downhole camera survey of diffusion wells.

Record pressures, temperatures, and flow rates monthly at a minimum. If flow meters are not permanently installed, strap-on ultrasonic flow meters should be used.

Check well water system strainers regularly, preferably once a month, for excess debris. Consider using fine mesh strainers (30 mesh) for at least the first year of operation, especially if well water system heat exchangers include small tube devices which are subject to blockage.

Verify that balancing valves are properly set.

Perform ground water analysis. Compare to the levels deemed safe by manufacturers of the building system and equipment.

Standing Column Wells

Periodically inspect casing, Porter shroud, and pumps to insure proper well performance. Field inspections should also confirm that the pump setting is below the lowest water level during bleed conditions.

Verify balancing valves are properly set.

If variable speed pumps are used, measure and monitor flow rates at various pump speeds.

Compare ground water chemistry and elevation to the levels deemed safe by manufacturers of the building system and equipment.

Test bleed rate seasonally to establish the optimum and safe rate. Bleed cycles should also be documented.

Perform controls testing and demonstration, especially of safety controls to prevent well pumps from operating in dry conditions and freeze protection controls during heating. Well pump controls, variable speed drives, and staging must also be checked.

Commissioning Considerations

Design Phase	Closed Loop Systems	Open Loop Systems	Standing Column Systems
Below Ground			
Witness Borehole Geophysical Logging	X	X	X
Review Sieve Analysis		X	
Review Water Sample Results		X	X
Witness Aquifer Pumping Test (Drawdown Test)		X	X
Verify/Document Ground Water Elevations	X	X	X
Review Historic Ground Water Levels for Areas	X	X	X
Above Ground			
Review Potential Land Availability for Well System	X	X	X
Review Project Goals (LEED Rating, Efficiency, etc.)	X	X	X
Above & Below Ground			
Create or Review Owner's Project Requirements and Basis of Design	X	X	X
Design Review Maintenance Accessibility	X	X	X
Design Review Operation Requirements	X	X	X
Design Review Training Requirements	X	X	X
Design Review Warranty Requirements	X	X	X
Design Review Replacement Parts Requirements	X	X	X
Add Cx Specifications to the Design Documents	X	X	X
Create a Cx Plan	X	X	X

Blank spaces = Not Applicable

Commissioning Considerations

Construction Phase	Closed Loop Systems	Open Loop Systems	Standing Column Systems
Below Ground			
Verify Driller's Equipment Has Been Disinfected Before Drilling	X	X	X
Confirm Well Screen Slot Size & Casing Selection		X	X
Confirm Well Screen Slot Size & Casing Installation		X	X
Witness Downhole Camera Survey		X	X
Review Additional Water Sample Analysis		X	X
Review Submersible Pump Installation		X	X
Review Tubing & Header Installation	X		
Witness Tubing Pressure Testing	X		
Witness Flushing of System Tubing	X		
Above Ground			
Review Pump Installation	X		
Review Heat Pump / Heat Exchanger Installation	X	X	X
Review All Primary & Secondary System Components	X	X	X
Review All Piping Pressure Testing	X	X	X
Witness Flushing of System Piping	X	X	X

Blank spaces = Not Applicable

Commissioning Considerations

Construction Phase	Closed Loop Systems	Open Loop Systems	Standing Column Systems
Above & Below Ground			
Update Cx Plan when Contractors are onboard	X	X	X
Review Submittals	X	X	X
Conduct Installation Review	X	X	X
Prefunctional/Start-up Review	X	X	X
Perform Functional Testing	X	X	X
Record All System Flow Rates, Temperatures and Pressures	X	X	X
Performance Verification/Trending	X	X	X

Blank spaces = Not Applicable

Commissioning Considerations

Acceptance/ Turnover	Closed Loop Systems	Open Loop Systems	Standing Column Systems
Above & Below Ground			
Review O&M Manuals	X	X	X
Review As-Built Documents	X	X	X
Review Training is Performed/Documented	X	X	X
Review Warranty Documents	X	X	X
Provide Final Report	X	X	X
Provide Systems Operations Manual	X	X	X
Conduct End of Warranty Review	X	X	X

Blank spaces = Not Applicable



6.0 List of Abbreviations

BMS

Building
Management
System

GHP

Geothermal
Heat Pump

GRCO

Ground Coupling

HCl

Hydrochloric Acid

HDPE

High-Density
Polyethylene

HVAC

Heating, Ventilation,
and Air Conditioning

HX

Heat Exchanger

IRB

Iron-Related
Bacteria

O&M

Operations and
Maintenance

SCW

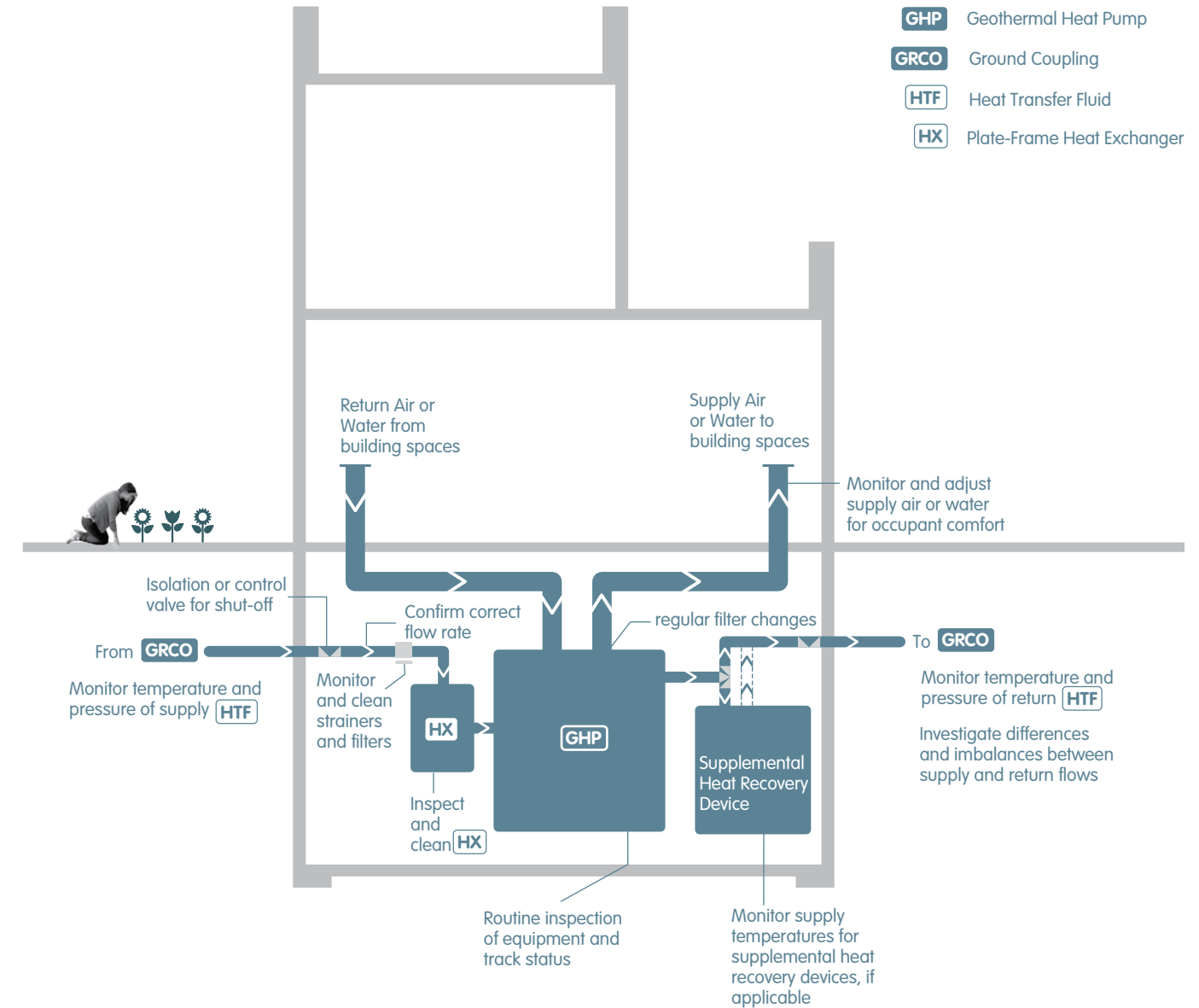
Standing Column Well

6.1 Operation and Maintenance

An effective operation and maintenance **O&M** program provides a clear path for maintaining optimal performance in building systems and efficient energy use. Activities range from scheduled inspections and routine cleaning to major servicing at critical points of operation and adjustments for future improvements. However, O&M is not just the responsibility of building managers or operators. Owners and occupants also play key roles in ensuring efficient building operation by assessing overall energy performance and providing feedback on the building environment.

Similar to other **HVAC** systems, O&M for **GHP** systems is essential to realize the system's full benefits. Although actual O&M required will vary, activities will focus on monitoring and inspecting equipment. However, occasional intensive servicing may also be necessary depending on the **GRCO** type. System design should take into account expected O&M procedures and incorporate the means to facilitate maintenance. Personnel training should also be included to ensure successful operation and extended system life cycle. **Figure 6.1** illustrates regular O&M procedures needed for GHP systems.

Figure 6.1
Typical Operation & Maintenance Areas



6.2 Operational Considerations

GHP system operation primarily involves controlling water pressure, flow, and temperature with specific high and low set points at various points in the system. Building operators will need to regularly observe and assess system operation to ensure that performance is maintained. A **building management system (BMS)**, which utilizes computerized monitoring and control of systems, can be incorporated to immediately signal any deviations as well as collect data for analysis.

Monitoring is accomplished using standard instrumentation such as flow meters, pressure and vacuum gauges, and water level sensors. Appropriate control points on these instruments can be tracked through the BMS, if available. Less sophisticated tools, such as direct digital readouts and manual measurements, can also be used in lieu of a BMS. Value engineering or eliminating measurement and control devices from the project should be avoided.

Operational data that should be monitored include, but not limited to the following:

All GHP Systems

Monitor pressure differential to confirm correct water flow to **GHP**.

Closed Loop Systems

Monitor **GRCO** make-up water flow to confirm that leaks are not occurring in the loop field.

Identify increase in head loss in main supply and return headers, which may indicate restricted flow from GRCO.

Confirm balanced flow to and from individual loop circuits.

Monitor supply and return temperatures from GRCO to confirm expected thermal capacity is achieved.

Open Loop Systems

Monitor supply and return ground water temperatures to confirm thermal loss is within expected range.

Monitor supply and return ground water pressures to identify increase in head loss, which may indicate restricted flow.

Verify pumps are delivering required demand flow at time of measurement.

Check specific capacity for individual supply wells to confirm supply well screen slots are not clogged.

Check flow rates and pressure at diffusion wellheads to confirm diffusion well screen slots are not clogged.

Check amperage and voltage draw of submersible pumps for restrictions in piping or unusually high drawdown.

Monitor particulate load in "Y" strainer, heat pump strainers, and other filters, if used, to identify break in supply piping or well screens.

Identify changes in ground water quality and determine if potential for scaling, corrosion, or biofouling has increased.

If necessary, obtain coupons and monitor for potential corrosion of metallic components of system.

Operational Considerations

Standing Column Wells

Monitor supply and return ground water temperatures to confirm thermal loss is within expected range.

Monitor supply and return ground water pressures to identify increase in head loss, which may indicate restricted flow.

Check for unusually high drawdowns of ground water levels during bleed and non-bleed operation.

Confirm balanced supply and return flows in each well.

Monitor particulate load in "Y" strainer, heat pump strainers, and other filters as applicable to identify break in supply piping or well screens.

Identify changes in ground water quality and determine if potential for scaling, corrosion, or biofouling has increased.

If necessary, obtain coupons and monitor for potential corrosion of metallic components of system.

Building operators should be well trained in **GHP** system operation, identifying and diagnosing operational issues, and making appropriate adjustments. Depending on the building owner's operational budget, it may be beneficial to hire a facility manager with specific GHP system experience. At a minimum, the building owner should engage an experienced mechanical contractor, maintenance contractor or consultant for technical support. A **CxA** may also be present to monitor installation, system start-up and operation during the initial year of use.

The mechanical and geothermal engineers should finalize **O&M** procedures prior to system start up and document them in the O&M manual. Specific training by the equipment manufacturers along with the manual will provide a complete view of a particular system's sequence of operation, controls, and monitoring devices. The manual will also serve as a guide for proper system operation in the future and for troubleshooting problems in both the GHP and **GRCO**. A building operator already familiar with conventional **HVAC** systems may be able to promptly address mechanical equipment issues. However, inexperience with identifying declining GRCO conditions may lead to greater maintenance or even abrupt system shut-down. As a result, the O&M manual will be a key reference tool for the building maintenance staff.

6.3 Maintenance

Maintenance is divided between the two components, the **GHP** and the **GRCO**. Similar to other heat pumps, GHP unit maintenance is generally limited to changing air filters and routine manual inspection. On the other hand, GRCO maintenance is more involved and varies significantly by type. Closed loop systems require the least amount of maintenance while open loop systems involve more monitoring and intervention. **Figure 6.2** shows an example of well maintenance using an impulse generation tool, where bursts of nitrogen are used to loosen material within the well.

As a general recommendation, overall system maintenance should be included in the building **HVAC** system maintenance contract. Routine inspection and performance checks by a licensed well contractor and good record keeping are especially essential for open loop and standing column well systems.

Closed Loop System

A closed loop system entails minimal maintenance since the **GRCO** is self-contained and isolated from the ground environment. **HDPE** piping used for the loops and headers is typically warranted for 50 years by the manufacturer, and does not usually require any maintenance. Once the loop field has been flushed out and pressure tested, routine maintenance includes periodic testing of the heat transfer fluid for balanced pH levels and proper concentration of biocide, corrosion inhibitors and antifreeze, if used.

The building operator should also regularly inspect the automated valves, sensors, control points, and other equipment such as pumps for proper operation. Replacements or repairs should be made as necessary. The make-up water system should be frequently monitored since any leaks in the piping will affect operation.

Figure 6.2

Well Maintenance: Open Loop System Impulse Generation Tool



Impulse generation creating nitrogen bubbles at well head

Maintenance

Open Loop Systems

Open loop systems are typically the most maintenance intensive of the three **GRCO** types because they are highly susceptible to ground water conditions. **O&M** focuses primarily on the pump and well screen. Regular maintenance of these components will avoid some of the more difficult rehabilitative methods.

Submersible Pumps

As the only mechanical component in the wells, the submersible pump set in the supply well normally lasts about 10 to 15 years. However, New York City's ground water can contain high concentrations of dissolved metals such as iron, organic pollutants and other dissolved minerals, which can cause greater wear on motors and impellers. More frequent servicing than typical may be necessary.

In most cases, a decline in the well's specific capacity indicates a problem with a supply well. Specific capacity is the pumping flow rate divided by drawdown in the well. An increasing drawdown means water cannot pass through the screen as easily, which may be the result of a clogged well screen. Increased power usage seen in amperage draw or voltage may also indicate a supply well-related problem.

Well Screen Rehabilitation

Properly designed and constructed well screens and casing should last the lifetime of the installation. However, even under good ground water quality conditions, screens eventually will require cleaning to remove silt, scale, other mineral deposits or biofilm that tend to accumulate over time. Well rehabilitation is a process designed to restore a well's efficiency. Rehabilitation involves cleaning the well screen, gravel pack, and aquifer immediately surrounding the well using various physical and chemical treatment procedures, including disinfection. The frequency of rehabilitation usually depends on ground water quality and characteristics. Rehabilitation about every 10 to 15 years is typical but greater frequency is often required for wells in New York City.

Diffusion wells typically require more frequent rehabilitation than supply wells. As ground water passes through the **HVAC** system, it can undergo chemical changes as a result of aeration, thermal exchange and mineral precipitation. Dissolved solids in the ground water may cause scaling on the interior of the well casing and block screen slot openings as water gradually reenters the aquifer through diffusion wells.

Maintenance

One particular issue of concern is naturally occurring iron-related bacteria **IRB**, which can metabolize iron in ground water and produce biofilm, a type of metabolic waste. Excessive biofouling can obstruct diffusion well screens and lead to a decrease in system efficiency along with higher maintenance costs. If unattended for a significant period of time, complete system failure is possible.

Rehabilitation of supply wells should be initiated before the specific capacity has declined by 25 percent and when a trend of increasing back pressure is noted in the diffusion wells. Good record keeping by building owners will quickly indicate any decline in performance and allow for necessary servicing sooner. Advanced damage to a well screen may result in the need for screen replacement or relining, and may make complete restoration impossible.

Concurrent to well rehabilitation, the **HX** and ground water piping should be flushed and disinfected. HXs should also be cleaned when the pressure differential across it increases. Cleaning typically involves flushing any sediments and acid washing to remove scale.

Rehabilitation Techniques

The sequence of some traditional techniques used in well rehabilitation is listed in **Table 6.1**. The first step involves a downhole well inspection with a video camera lowered into the well to record interior conditions of the screen and casing. Encrustations and biological growth on the casing or screen are then visually inspected to identify the cause and extent of the problem. **Figure 6.3** shows a downhole video inspection in progress, diagnosing existing conditions just prior to well rehabilitation.

Once identified, a treatment method can be developed based on whether the source is geochemical or biological in nature. However, before moving to chemical treatments, the well should be wire brushed to remove and loosen heavy debris coating the casing and well screen. **Figure 6.4** is a typical wire brush used for this application. Other physical techniques may be used to further loosen and remove material, including high pressure water jetting, segmental air lifting, and impulse generation. These methods are meant to agitate the surrounding aquifer and break up solid materials by force. Solutions of hydrochloric acid **HCl** are the preferred treatment for inorganic deposits, such as iron oxide. Disinfection after physical and chemical treatment will kill remaining bacteria colonies in and around the well screen.

Figure 6.1

Well Rehabilitation Tools and Techniques

Tool or Technique

Application

1. Video well inspection

Visually inspect well condition to identify type of problem (geochemical, biological or physical) and severity.

2. Wire brushing

Physically loosen biological growth and mineral precipitation from the well casing and screen.

3. Water jetting

Use high-pressure water injection to loosen material on screen and gravel pack.

4. Bailing

Manually remove loosened debris that falls to well bottom.

5. High-pressure segmental air lifting

Inject air within screen zone to remove loosened debris and material from filter pack and surrounding area, and purge well.

6. Impulse Generation Tool

'Burst' of nitrogen to loosen foreign matter from well screen and surrounding area.

7. Hydrochloric Acid (HCl) treatment

Dissolve metal compounds encrusted on well screen, gravel pack and surrounding area.

8. Disinfection by chlorination

Kills bacteria colonies in well, filter pack, and screen area.

9. Surging

Use plunger-type device to force acid and disinfectant into filter pack and surrounding area.

10. Pumping

Pump well using submersible pump for additional removal of debris from filter pack and surrounding area. Can be used after procedures 2 through 5. Also used to remove residual acid and disinfectant after Procedures 7 and 8.

Figure 6.3

Downhole Video Inspection: Open Loop System



Figure 6.4

Well Rehabilitation Tool: Wire Brush



Maintenance

Impulse generation technology is an innovative technique for loosening material in and around a well screen that has been used successfully by [DDC](#). A Hydropuls® impulse generation tool was used at the Brooklyn Children’s Museum and Queens Botanical Garden to rehabilitate the supply and diffusion wells, which were clogged by biofilm and mineral precipitates. The tool is lowered to the screen zone while sending out ‘bursts’ of compressed nitrogen gas to dislodge foreign matter from the well screen and the surrounding area. [Figure 6.5](#) shows an impulse generation tool and how it is lowered into the well.

During pulsing, ground water and loosened debris are simultaneously pumped from the well using a submersible pump. [Figure 6.6](#) illustrates the change in ground water pumped before and after using impulse generation. As biofilm and precipitated iron are removed, ground water becomes clearer to confirm well rehabilitation.

The final step in treatment is pumping and properly disposing of wastewater. Approximately ten times the volume of the chemical disinfectant used needs to be pumped off to clear out the well. The wastewater must be neutralized before being released to a sewer for disposal. Large quantities of wastewater require use of a temporary holding tank and a sewer discharge permit [1](#) from [NYCDEP](#). Once treatment and disposal is completed, a second video inspection is performed in order to document the results. [Figure 6.7](#) provides video screenshots of one well screen before and after rehabilitation.

[1](#) For more information, see [C3 NYC Permits and Filings](#)

Figure 6.5

Well Rehabilitation Tool: Impulse Generation



Hydropuls® tool



Technician lowering tool into well

Figure 6.6

Ground Water Pumped During Impulse Generation



Biofilm and precipitated iron pumped from well

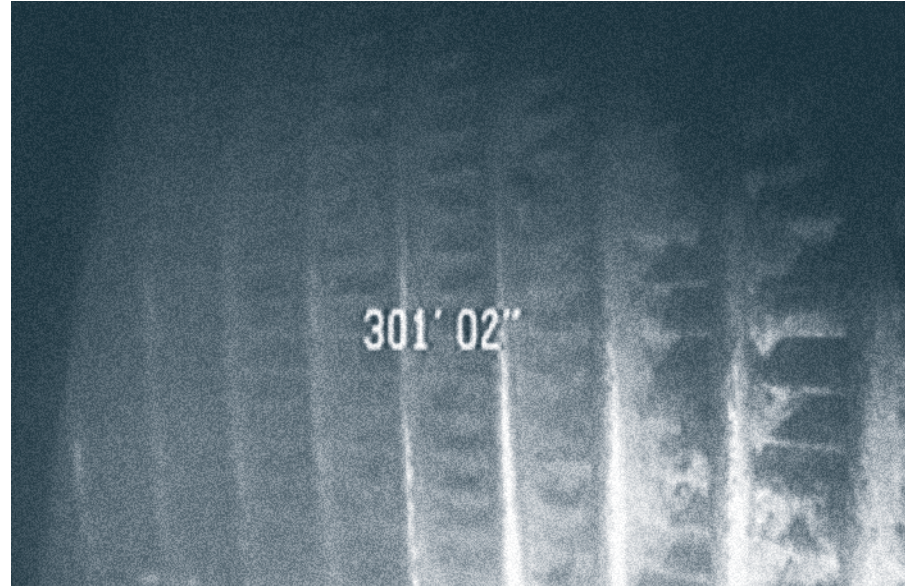


Clear ground water after impulse generation

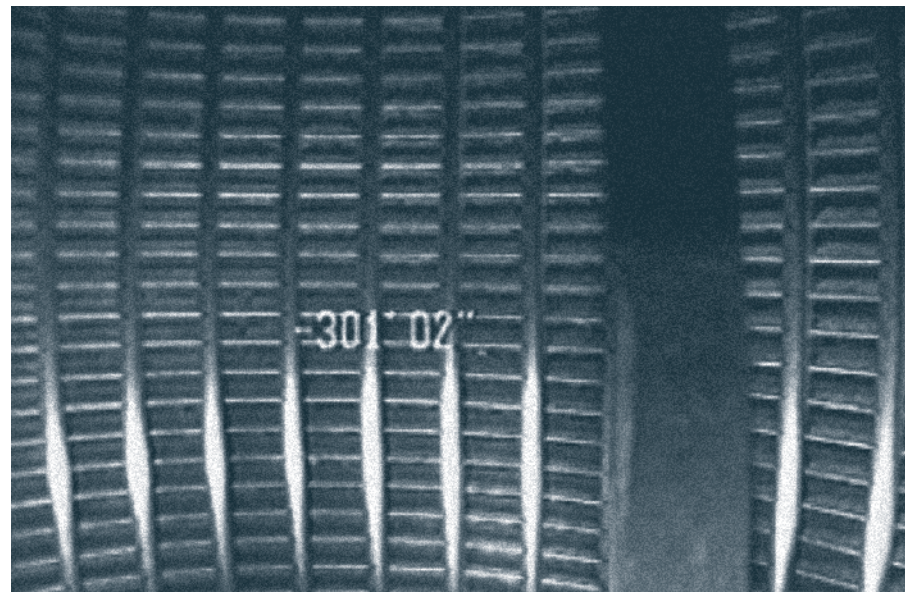


Figure 6.7

Images from Downhole Well Inspection



Top: Well screen before rehabilitation



Bottom: Well screen after rehabilitation

Maintenance

Standing Column Well System

Similar to an open loop system, properly constructed wells for a **SCW** should last the lifetime of the installation. The submersible pump and its components will routinely need to be serviced or replaced. If a **HX** is used, it should be regularly inspected and cleaned. SCWs are also susceptible to pump motor burnout if the return flows are not properly balanced or if bleed is uncontrolled, allowing the water levels drop too far and cause the pumps to work harder than expected.

Unlike open loop systems, there is no well screen to clog, and biofouling has not been an issue in the City. However, because of insufficient historical data for operating SCW systems, long-term effects on well performance are unknown. Rock particles of various sizes may accumulate at the bottom of the well over time and could obstruct the shroud perforations. The particles may affect water circulation and may eventually need to be flushed from the well. In extreme cases, the shroud may need to be pulled from the well to remove particles and re-installed.

Case Studies



Case Studies

As New York City's primary capital construction project manager, the Department of Design and Construction **DDC** administers a diverse scope of work in various building types and sizes. In recent years, DDC has encouraged the implementation of **GHP** systems to address space conditioning demands while reducing energy consumption. As a result, DDC has acquired first-hand knowledge and experience in designing and operating GHP systems. The following are notable projects that provide considerable insight on the use of geothermal within the City.

- 1. Brooklyn Children's Museum**
Open Loop System
- 2. Queens Botanical Garden**
Open Loop System
- 3. Weeksville Heritage Center**
Closed Loop System
- 4. Lion House at the Bronx Zoo**
Standing Column Well System
- 5. Staten Island Museum at Snug Harbor**
Closed Loop System



Brooklyn Children's Museum Open Loop System

Originally established in 1899 in Brower Park, the museum is currently situated in the Crown Heights section of Brooklyn. A new 55,000 sq. ft. addition opened in 2008 and doubled the total building size to 110,000 sq. ft. The new museum incorporated many sustainable design features and achieved a **LEED** Gold certification from the **USGBC**. As part of the overall energy use reduction, a **GHP** system was installed, which also avoided the use of unsightly cooling towers on the rooftop, eliminated on-site noise and fossil fuel emissions.

The museum's design team chose an open loop system with two supply and two diffusion wells, each at a depth of 345 feet into the Jameco aquifer ¹. Two supply wells, designed for a maximum pumping rate of 400 gpm, were necessary to meet the museum's peak load. Each well casing was constructed with eight-inch diameter galvanized steel casing, and the well screens with wire-wrapped, schedule 80 stainless steel. Screen lengths for the supply and diffusion wells are 100 feet and 200 feet, respectively, and each designed with a slot size of 0.040. Twenty-three heat pumps were installed with an approximate total capacity of 350 tons.

Drilling conditions at this site were problematic because of numerous boulders encountered. The museum is located near the terminal moraine, which consists of unstratified glacial drift such as boulders deposited during the last glacial period over 10,000 years ago. Boulders can slow drilling time and increase costs. During this project, the drillers either drilled through the boulders or relocated the well to avoid further difficulties.

Although the building was substantially completed in the fall of 2007, problems developed shortly during system start-up, which were attributed to the buildup of biofilm on the well screens from **IRB** and mineral deposits naturally found in ground water. Excessively hard water and accumulation of biofilm deposits can clog the diffusion well screens and restrict water returning to the aquifer. Iron bacteria are naturally present in ground water, and can proliferate if the water is also naturally high in dissolved iron, which acts as a food supply for the bacteria. Aerating the water and increasing the temperature as it runs through the **HVAC** system can also exacerbate the problem.

Chlorination of each well is generally the treatment of choice, but does not cure the problem. Moreover, permitting by the **NYSDEC** did not allow chemical treatment because of potential ground water contamination. Consequently, a thorough, mechanical re-development of each well using various industry methods was necessary to restore the system performance to the original design. Alternative, non-chemical treatments are also currently being investigated by DDC to maintain the integrity of the system post-redevelopment. The GHP system is presently working as originally designed, and periodic down-hole video monitoring by the DDC confirms that the well screens are free of any biofilm and mineral deposits.

Total Building Area: 55,000 sq. ft. (new addition only) **Building Loads:** 2,661,000 Btu/h for heating, 275 tons for cooling **Number of Wells:** 2 supply, 2 diffusion **Number of Heat Pumps:** 23 units **LEED Certification:** Gold



Brooklyn Children's Museum

- 1a Supply Wells
- 1b
- 2a Diffusion Wells
- 2b

Challenges:

Ground water contains moderate to high amounts of iron and other dissolved minerals and inorganics, which can precipitate onto well screens, piping and valves.

Ground water contains moderate amounts of **IRB**, which can clog well screens with biofilm-type deposits if not properly treated.

Wells remained idle for extended periods of time after construction, which may have contributed to 'silting in' of wells and IRB growth on the well screens.

NYSDEC permit did not allow use of chemical treatment or introduction of disinfectant to the aquifer.

Subsurface beneath the site contains numerous glacial boulders, making drilling difficult.

Use of mud rotary drilling method may have imbedded drilling mud into the well screen area and filter pack, which can be extremely hard to remove and may impede the flow of water back to the aquifer.

¹ For more information on aquifers, see [Chapter 3](#)

Queens Botanical Garden Open Loop System

The Queens Botanical Garden is located in Flushing, Queens. The Garden, which is open to the public, is situated on 39 acres of diverse garden landscapes in an ethnically diverse neighborhood. It originally started as part of the 1939 New York World's Fair and eventually expanded into Flushing Meadows-Corona Park. During construction for the 1964 World's Fair, the Garden was relocated to its current location across the street from Flushing Meadows-Corona Park. Because of the Garden's environmental stewardship and multicultural diversity, it decided to undertake an ambitious sustainable agenda for its new administration building and visitor's center. At the completion of the project in 2007, the building was awarded the **LEED** Platinum certification, the highest award for a 'green' building, and also the first in New York City to attain this designation.

A **GHP** system was considered to help reduce energy consumption for heating and cooling, and an open loop system was selected and incorporated into the building design. The two-story structure provides approximately 16,000 sq. feet for both administrative offices and public spaces. Based on the building's cooling load of 37 tons and 378,100 Btu/h for heating, one supply well and two diffusion wells were installed. Each of the three wells was drilled and completed at 305 feet below grade using black pipe steel for casing, and 120 feet of schedule 80 stainless steel screen at the bottom. Eight individual heat pumps are used to provide 10 tons per unit, however only 4 or 5 of the units are used at any one time, depending on demand. The maximum pumping rate for the supply well was designed for 160 gpm.

Final depth of the well and screen placement was determined by interpreting the geophysical log of a test well in addition to correlating the driller's logs and sieve analyses for grain size distribution. After confirming the viability of the test well, it was later converted to a supply well. Well completion reports from an old, existing onsite irrigation well were also reviewed to corroborate subsurface information for the GHP system.

Soon after system startup, at least one of the diffusion wells developed higher than normal back pressure and restricted flow rates. Detailed downhole video analysis of each diffusion well indicated that a thorough redevelopment of the wells was necessary. Both traditional and newer, innovative technologies were used for the development. An 8-inch circular, wire brush was first lowered into each well with a drill rig to 'scrub' and physically dislodge any encrusted, solid material on the interior wall of each well. An impulse generation tool was then lowered near the well screen, which sent out a 'burst' of compressed nitrogen gas, approximately 100 feet radially to dislodge any foreign matter such as biofilm within the aquifer. Ground water was then pumped out of each well containing the loosened waste material and properly disposed. Pulsing and pumping within each well continued until ground water was determined to be free and clear of any turbidity.

After well redevelopment, an in-line ultra-violet (UV) purification device was installed just after the supply water entered the building to disinfect the **IRB** that caused the biofouling. Other new technologies, which require no energy source or maintenance, are also currently being tested for long term use. An additional well in the near future is planned to supplement the existing system.

Total Building Area: 16,000 sq. ft. **Building Loads:** 378,100 Btu/h for heating, 37 tons for cooling **Number of Wells:** 1 Supply, 2 Diffusion **Number of Heat Pumps:** 8 units **LEED Certification:** Platinum



Queens Botanical Garden
Administration Building

Challenges:

Deposits within the aquifer contained large amounts of clay that may have reduced permeability.

Ground water contained moderate amounts of dissolved iron that can precipitate onto piping and valves.

Ground water contained moderate amounts of **IRB**, which can clog well screens with biofilm-type deposits.

Botanical Garden facility is in a high water table area.

Wells were completed prior to building construction and remained idle for long periods of time, which may have contributed to IRB growth.

NYSDEC permit did not allow the use of chemical treatment of wells or introduction of disinfectant to the aquifer.

Site geology is complex and glacially altered, therefore determining which aquifer the wells were screened in was difficult. NYSDEC does not allow the use of the deeper Lloyd aquifer to be used for non-potable supply.

Use of mud rotary drilling method can imbed drilling mud into the well screen and surrounding gravel pack, which is extremely hard to remove and impedes the flow of water back to the aquifer.

Weeksville Heritage Center Closed Loop System

The Weeksville Heritage Center, located in Bedford-Stuyvesant, is a two-story exhibition and research building dedicated to the African American community who lived in this Brooklyn neighborhood over one hundred years ago. The center will support the Weeksville Society and the restored post-Civil War era Hunterfly Road houses adjacent to the new building. The building is currently under construction and is expected to be completed in 2012. Numerous sustainable features were included in the design, and the project is anticipated to achieve **LEED** Gold when completed.

The Society decided to use a **GHP** system for space conditioning and to reduce the building's energy consumption. The center's site has similar ground water conditions as the Brooklyn Children's Museum, and because of its inherent efficiency, an open loop system was originally chosen for the site. DDC initially drilled three test wells and performed borehole geophysical logging down to 270 feet as well as conducting an aquifer pumping test. Computer modeling of the pumping scenario was also performed to determine the aquifer's hydraulic properties and its sustainability. A thorough hydrogeological study confirmed that the aquifer would be able to provide the capacity of ground water necessary for an open loop system.

However, after careful evaluation of the water quality, the analysis showed that elevated iron levels might contraindicate the use of an open loop system because chemical treatment might also be required. The potential for **IRB** proliferation and biofouling of well screens was a serious concern for future operation and system longevity. The project team later revisited the other **GRCO** systems and confirmed that a closed loop system would also be suitable for the project and provide the added benefit of reducing future maintenance.

The amount of open land on the project site was the determining factor that allowed the design team to pursue a closed loop system. Because the new building only occupied a small portion of the 1.5 acre site, sufficient area was available to properly accommodate a closed loop system. The **HVAC** system ultimately required 48 closed loop boreholes, 20 feet apart with a depth of 450 feet to provide adequate capacity for heat exchange. Loops are grouped into four per circuit, routed to a central manifold vault, and then piped to the building's mechanical room. Building equipment consists of ten GHPs that provide a total of 108 tons of peak cooling.

The land above the loop field will be landscaped and serve as part of the center's exhibition spaces as well as the on-site stormwater management system. The closed loop circuits are closely coordinated with underground stormwater lines and other appurtenances to avoid installation and operation problems.

Total Building Area: 16,400 sq. ft. **Building Loads:** 108 tons for cooling
Number of Boreholes: 48 closed loop boreholes **Number of Heat Pumps:** 10 units **LEED Certification:** Gold (anticipated)



Weeksville Heritage Center
Site during loop drilling

Challenges:

Decision of using an open loop system with potential for **IRB** issues or switching to less efficient and costlier closed loop system.

Ground water contained moderate amounts of dissolved iron, that may precipitate onto well screens, piping and valves of an open loop system.

Boulders deposited by the terminal moraine at times slowed the drilling of wells and boreholes.

Coordinating drilling of 48 closely-spaced loop boreholes and connector piping with other site features, including the stormwater management system that uses underground drainage piping, drywells, a constructed wetland, filtering soils and liners.

Coordinating loop field installation after removal of contaminated urban fill.

Lion House at the Bronx Zoo

Standing Column Well System

The 1903 Lion House building at the Bronx Zoo is a NYC Historic Landmark, and currently houses the Madagascar exhibit, which contains animals, insects and plant life from that region of the world. The renovated building was completed in 2006 and achieved **LEED** Gold certification for sustainability. A standing column well system was installed to eliminate the need for cooling towers, supplementing an onsite fuel cell, a cogeneration plant and a condensate waste heat recovery system.

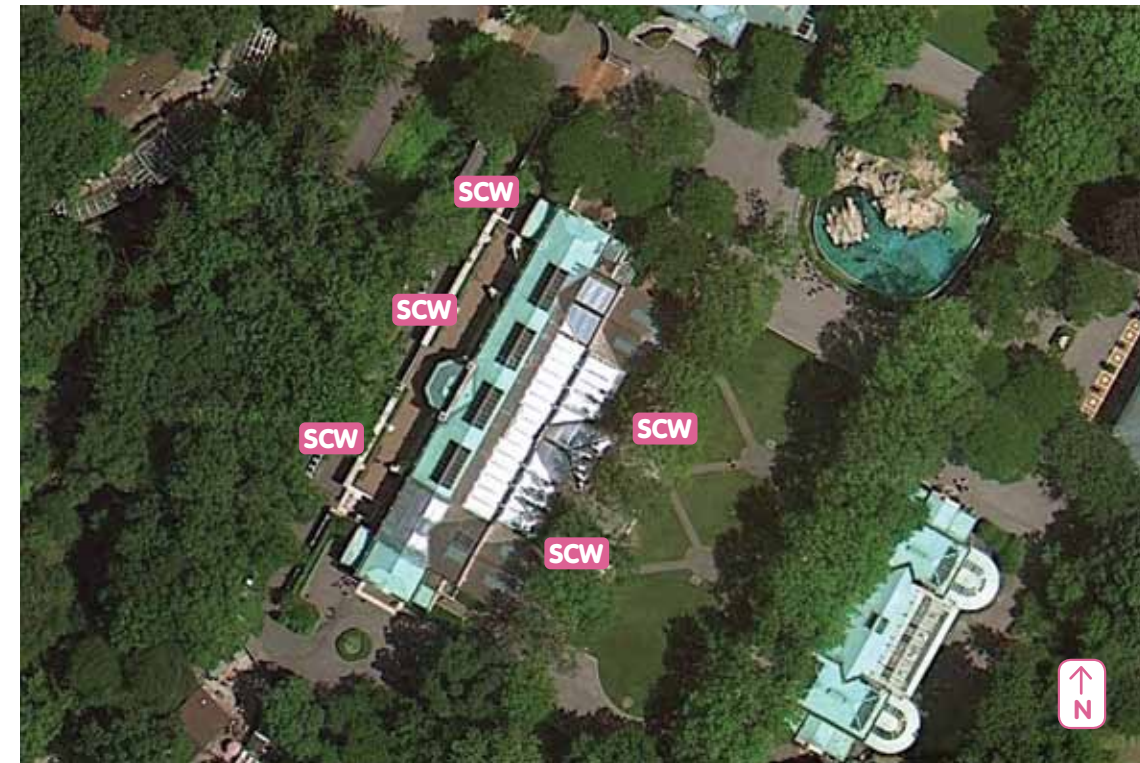
The six water to water heat pumps installed provide heating and cooling for the 40,000 sq. foot building. Each heat pump provides 30 tons of cooling and 300,000 Btu/h of heating, with a source water temperature of 80 °F for cooling and 45 °F for heating. Total well water flow design rate is 544 gpm, or 108 gpm per well.

Five standing column wells at 1,500 feet deep were drilled into competent bedrock known as the Hartland Formation ², which is the principal bedrock unit found at the site and is comprised of crystalline mica schist. Prior to drilling a test well, a non-intrusive geophysical survey utilizing seismic reflection was conducted to verify if any major faults or fractures existed in the area. Intercepting major faults or fractures would have increased the probability of finding a highly productive fractured bedrock aquifer. By sending seismic signals deep into the ground using a systematic approach, individual bedrock units were differentiated by the travel time through each layer and its reflection back to the surface. The geophysical investigation was conducted after hours in the evening to avoid disturbing any of the zoo animals.

Geophysical profiles were completed along a north-south line on the west side of the Lion House and administration building. A second shorter profile was run perpendicular to this line along the south side of Cope Lake. A third profile was run parallel to and approximately 700 feet to the east of the first long profile. The geophysical investigation determined that there were substantial fractured or fault zones beneath the area. Correlations to fault zones appeared at an average depth of 700 feet below grade and as deep as 1,000 feet. A test well was drilled to 1,300 feet and indicated sufficient ground water yield for a standing column well, but not for an open loop system. The average ground water yield for this type of formation is 40 gpm with an average temperature of 55 °F.

Analysis of the borehole geophysical logs also indicated that the bedrock was competent, and would be able to provide sufficient ground water for the system. Subsequently, the five open boreholes were constructed with an 8-inch diameter steel casing and cemented 50 feet into competent bedrock as per New York State regulations.

Total Building Area: 40,000 sq. ft. **Building Loads:** 1,057,000 Btu/h for heating, 56 tons for cooling **Number of Wells:** 5 Standing Column Wells **Number of Heat Pumps:** 6 units **LEED Certification:** Gold



Lion House
SCW Standing Column Wells

Challenges:

Pieces of bedrock within the borehole can dislodge and fall into the well, creating system problems. Balancing the supply and return flows to multiple wells interconnected by a manifold with a varying yield can be problematic.

Performing aquifer pumping tests of individual and multiple wells pumping together to evaluate the aquifer's hydraulic response during system operation is critical. Determination of a seismic fault zone under site to locate water-bearing fractures.

² For more information on bedrock formations, see [Chapter 3](#)

Staten Island Museum at Snug Harbor Closed Loop System

The Staten Island Museum (SIM) will be expanding into a new location at the Snug Harbor Cultural Center (SHCC), an 83-acre National Historic Landmark on Staten Island's north shoreline. The museum will be housed in the newly renovated Building A, which is approximately 16,800 sq. ft. of total area over five floors. The museum renovation is also anticipated to achieve a **LEED** Silver certification when completed.

With its diverse collections and archives, the museum will need to be temperature and humidity controlled. Heating and cooling loads were estimated to be 1,114,400 Btu/h and 91.5 tons for the building. Rooftop chillers would have significantly changed the historic fabric and required structural reinforcement or reconstruction of the existing roof. A **GHP** system allowed the historic envelope to remain intact and would not create a visual obstruction elsewhere on the site. As part of the final design, a closed loop system is currently being installed in an open field nearby to serve the building.

Initially, NYC **DDC** drilled one test borehole down to a depth of 870 feet to evaluate the feasibility of a standing column well system. After drilling to 150 feet, unfractured to moderately fractured bedrock was encountered, primarily composed of serpentinite and schist. Based on serpentinite samples elsewhere in the city, there was a high probability that this rock type would contain chrysotile, an asbestos containing mineral, and might trigger additional environmental concerns. However, analysis of drill cuttings for asbestos containing minerals was negative.

Also, after conducting a pumping test on the borehole, the results indicated that the maximum ground water yield possible was only 6 gpm, which did not meet the minimum requirements for a sustainable SCW. Combined with the possibility of generating asbestos fibers, the low yield signaled that a SCW or an open loop system would not be appropriate. Ultimately, a closed loop system appeared to be the best option for this project. The facility had the necessary available outdoor space to accommodate the loop field and other system components, and would be isolated from the unfavorable subsurface conditions.

Two borings for test loops were completed to verify geologic conditions in separate corners of the proposed loop field and measure the ground thermal conductivity and diffusivity. Ground water temperature was determined to be between 56 and 61 degrees Fahrenheit. Although not dependent on ground water temperature, the water can increase thermal conductivity and improve the system's efficiency during the heat exchange process. In this case, lower ground water temperatures would help remove heat from the loops and increase efficiency during cooling applications.

The loop field is approximately 43,000 sq. ft. and holds the required 32 boreholes, each at a depth of 500 feet. The loops are comprised of a nominal 1.25 inch **HDPE** plastic tubing installed in 6-inch diameter boreholes, backfilled with thermally enhanced grout. Four loops are tied into one circuit and each circuit is routed to the manifold, a buried vault located in the center of the loop field to conserve space inside of the building. The manifold will be connected to the building's mechanical system and heat pumps using 6-inch supply and return headers.

Total Building Area: 16,800 sq. ft. **Building Loads:** 1,114,400 Btu/h for heating, 91.5 tons for cooling **Number of Boreholes:** 32 boreholes, 500 ft. deep **Number of Heat Pumps:** 5 units **LEED Certification:** Silver (Anticipated)



Snug Harbor Cultural Center

- A** Staten Island Museum, Building A
- 1** Loop Field

The closed loop system is essentially maintenance free and does not require any special shafts or openings other than at the manifold vault. The loop field will be fully restored to its original use as an open landscaped area with walking paths. Completion of the loop field is expected in 2012.

Challenges:

- Making decision to switch from standing column well to less efficient and costlier closed loop system

- Locating loop field in area with mature trees that necessitated removal or relocation by the Parks Department

- Adjusting field size and borehole spacing to accommodate the building's strong cooling dominant profile, and avoid long-term thermal build-up in the ground.

Appendix A

A1 Hydrogeology and its Limiting Factors on GHP Systems

A.1 Consolidated Bedrock

The Bronx is underlain by three primary rock types, which from oldest to youngest are: the Fordham Gneiss, Inwood Marble, and Manhattan Schist. According to Bulletin GW-32, published by Perlmutter and Arnow, 1953, the Inwood Marble is the most productive source of ground water among the pre-Cambrian, Cambrian-Ordovician rocks in the Bronx. They typically yield 75 gpm and range from 1 to 300 gpm. Water quality is generally acceptable from this formation, however, hardness and alkalinity issues may be a problem in some locations for GHP equipment.

The Manhattan Schist, a hard green to black, micaceous rock is generally less productive than the Inwood marble. Dissolved iron in the schist is common which can in excessive amounts create problems for well pumps and screens, however alkalinity and hardness are lower than in the marble. Most productive supplies of ground water are found at depths less than 300 feet. Drilling deeper for water is possible, however, all water in bedrock is held in the interconnected fractures which generally

decrease in size with depth. Depth to bedrock ¹ varies dramatically throughout the five boroughs from sheer rock wall exposures at the surface in northern Manhattan and Bronx to over 1,000 feet below the surface in southern Queens.

In general, most of the bedrock beneath the City is hard, competent material that can easily be drilled for a geothermal loop or well. However, certain formations such as the Inwood Marble, Fordham Gneiss, and Staten Island Serpentinite ², may pose problems during construction. Depending on its location, serpentinite may contain natural asbestos fibers. Therefore, samples should be tested and, if present must be disposed properly as a regulated hazardous material.

The Fordham Gneiss is a massive, unfractured rock that may yield low or no ground water for **SCW** bleed. Test wells on Roosevelt Island indicated an extremely low yield that did not meet the design bleed criteria. Consequently, the use of standing column wells for this location was not feasible.

A 2 Unconsolidated Deposits

The unconsolidated, glacial deposits are primarily located in Brooklyn and Queens and form the six major hydrogeologic units, four of which comprise the major aquifers that supply ground water to these boroughs. Ground water in the other boroughs generally originates from fractured bedrock formations producing significantly less yield than from the unconsolidated deposits. The four aquifers in mention in descending order are: the upper glacial, the Jameco, the Magothy, and the Lloyd. These deposits are not always continuous throughout the boroughs, and can vary in thickness.

The two major confining units are the Gardiners Clay, also known as the Gardiners Clay Confining Unit, and the Raritan Clay or Raritan Confining Unit. Each has its own identifying characteristics which are used to differentiate one deposit from the other. The Gardiners Clay is a greenish-brown, shallow marine deposit of late Pleistocene age of low permeability, formed during the third interglacial period. It is generally found as a confining layer between 0 and 150 feet thick, usually overlying the Jameco and Magothy aquifers.

The Raritan Clay or Raritan Confining Unit is also low in permeability and generally overlies the Lloyd aquifer. It is usually found as a gray, red or whitish deposit, composed of clay and silt with some beds of Cretaceous sand and gravel. The occurrence of the mineral pyrite (fool's gold), and lignite, a brownish-black coal are indicative of this deposit. Generally, this clay which is 0 to 200 feet thick is missing in the northern and western parts of Brooklyn and northern Queens.

The aquifer system throughout the City has been extensively studied and mapped by the USGS and other City and New York State agencies. The following is a summary of each aquifer and its properties:

The upper glacial aquifer is the uppermost water bearing unit in Brooklyn and Queens, consisting primarily of glacial outwash deposits of sand and gravel south of the terminal moraine, and ground moraine deposits north of the terminal moraine. Thickness ranges from a few feet in northwestern Queens to about 150 feet in south central Queens. North of the terminal moraine the aquifer thins and contains more clayey and silty till and ground moraine. Therefore, deposits in this area are less permeable, and yield less ground water than south of the terminal moraine. According to the USGS, large public supply wells in the outwash deposits south of the terminal moraine have produced as much as 1,500 gpm. However, because this aquifer is closest to the surface, it is generally the most contaminated from surface runoff and man-made pollution.

According to the publication, Geologic and Geohydrologic Reconnaissance of Staten Island, by Julian Soren, USGS, 1988, it is reported that the outwash deposits on Staten Island consist mainly of sand and gravel beds containing minimal amounts of clay and silt, making them highly permeable. However, these deposits are not as thick or as extensive as compared to the ones in Brooklyn and Queens. The maximum thickness reported is 125 feet near the eastern shore. Sandy till deposits on Staten

Unconsolidated Deposits

Island generally yield small quantities of water, domestic wells commonly yielding around 10 gpm. Therefore, according to Julian Soren, large sustained yields should not be expected from wells completed in till. However, the outwash sand and gravel deposits in southeastern Staten Island and southern Manhattan contain abundant ground water supplies. In the borough of Bronx, the deposits are thinner than in other parts of the City, and therefore do not supply much water to wells.

The Jameco Gravel is present in most of Brooklyn and Queens. Thickness of the Jameco ranges from a thin edge to the north to more than 200 feet in the center of Jamaica Bay. Jameco deposits are generally composed of igneous, metamorphic and sedimentary rocks, and are typically dark brown. Deposits grade from a coarse sand and gravel with cobbles and boulders in northern Brooklyn to finer grained deposits in the south. Previous authors have suggested that the Jameco Gravel was probably modified by stream erosion and glaciation.

According to the USGS, the Magothy and Jameco deposits differ in origin, character, and water-transmitting properties. However, they are generally considered to be one unit. The Magothy consists of beds and lenses of clay, clayey and silty sand, fine to coarse sand, and gravelly sand. The aquifer ranges in thickness from zero in western and northern Queens to about 450 feet in Far Rockaway. Wells in the Magothy have been known to yield as much as 1,500 gpm. In northern Queens, the Magothy reaches above mean sea level and is hydraulically connected to the water-table aquifer.

Deposits in the Lloyd aquifer are the oldest Cretaceous deposits in the area, and generally the deepest. However, it is absent in the northern parts of Brooklyn and Queens. The deposits are composed of fine to coarse quartzose sand mixed with sand and small to large pebble quartzose gravel. It ranges in thickness from zero at its northern extent to about 200 feet in southeastern Brooklyn and 300 feet in southeastern Queens.

A 3 Well Yield

Well yield is the volume of ground water per unit of time that can be pumped from a geologic formation, which is critical for open loop and **SCW** systems. Actual well yields must be verified with field testing and estimated by a contractor during drilling; regardless of published data. High initial yields may not be sustainable and may only reflect isolated zones of water-bearing fractured bedrock. Therefore, the maximum sustainable yield should be determined from a pumping test after well installation.

In general, extremely high well yields are possible from the aquifers in Brooklyn and Queens while bedrock in the City is typically much lower. Yields from the City's bedrock formations however, may be high enough to support bleed for a **SCW** system.

A 4 Depth to Ground Water

Depth to ground water ³ is important for open loop and standing column well systems because deeper ground water requires more energy from the pumps to overcome the higher pressures above. Pumping flow rates also drop off accordingly. During bleed cycles for a standing column well, depth to ground water is lowered even further. Experience has shown that at depths greater than 100 feet below the surface, the required energy for the pumps begins to exceed the energy efficiency savings of a geothermal system.

In an open loop system, a large depth to water increases the horsepower size of the pumping unit motor, but allows for a large recharge head to be developed in the diffusion wells. Larger mounds can also be accommodated around the diffusion wells. For most open loop systems in Brooklyn and Queens, a depth to water of at least 25 to 30 feet is usually adequate. On the other hand, very shallow water levels of less than 10 to 15 feet below the surface pose potential problems from flooding of the wellheads, which generally occurs at lower ground elevations, typically areas close to the shoreline.

Ground water elevations in the aquifers of Brooklyn and Queens are routinely measured by the USGS and have been published for many years, unfortunately no comprehensive mapping has been conducted in Manhattan, Bronx, or Staten Island. The **USGS** published generalized ground water elevations of Staten Island in two separate reports, see bibliography. However, the actual depth to ground water in bedrock can only be determined at a specific location by measurements from a screened well.

Often, existing water level data are available for project sites that were obtained during a geotechnical investigation. Interpretation of data from these wells should be used with caution for evaluating depth to ground water in bedrock. These wells are generally shallow and screened in unconsolidated deposits or only into the top of bedrock. The water levels are usually very different than those measured in wells installed in bedrock, because ground water is found under different hydraulic conditions.

³ See [Table 3.3](#) for favorite conditions of Depth to Ground Water for each of the GRCO system types

A5 Ground Water Quality

Ground water quality data available from the **USGS** are generally limited for the City. Ground water sampling by the USGS and investigations for **GHP** systems indicate that ground water in the upper glacial and Jameco aquifers range from hard to very hard, which can lead to scale deposits, especially for open loop systems in Brooklyn and Queens. Very hard water is considered to have a CaCO_3 concentration over 180 milligrams per liter. Hardness is generally less of a problem in the deeper Jameco aquifer than the shallower upper glacial.

Ground water in Brooklyn and Queens may also contain potentially unacceptable levels of iron, **IRB**, chloride, and organic compounds that could promote biofouling, iron encrustation, and corrosion of system components. The USGS has attributed the elevated hardness and chloride concentrations in Brooklyn and Queens to impacts from urbanization and saltwater intrusion.

Corrosive conditions can be managed through the use of plastic piping, dielectric couplings, and stainless steel or titanium plates in heat exchangers. Scaling is less prevalent than corrosion and can be managed with routine cleaning such as acid washing of the heat exchanger. However, biofouling and iron encrustation are more difficult conditions to control and once started, are even more difficult to eliminate. Concentrations

of man-made pollutants may also exceed those that the **NYSDEC** will allow for issuance of a Long Island Well permit.

Treatment of these constituents to acceptable levels is typically cost-prohibitive. Well redevelopment has been required for two open loop geothermal systems in Brooklyn and Queens to restore system performance. Subsequent to redevelopment of the wells, several innovative, non-chemical, low energy use technologies have been tested at both facilities with very promising results. The problem is generally not curable, because of the inherent chemistry of the aquifer. However, technologies that are not labor or energy intensive, or chemical in nature should always be investigated prior to conventional treatment.

IRB which can cause biofouling of well screens is commonly found throughout the world and is common in one or more aquifers, especially in Brooklyn and Queens. Whenever an open loop system is contemplated, dissolved iron and **IRB** should always be analyzed in ground water. If levels are determined to be too high, a risk assessment should always be considered.

Ground Water Quality

Experience has shown that ground water quality from schist formations beneath the City is generally acceptable for operation of a standing column well, except for shoreline areas where ground water may be brackish. Seawater contains compounds such as chloride, calcium and magnesium that could lead to corrosion and/or scaling of the submersible pump, piping, and other mechanical equipment.

USGS investigations have indicated that Manhattan's ground water may be low in dissolved oxygen. During pumping of a well, ground water is aerated, which can result in precipitation of dissolved iron, if present onto system components. Special precautions and design measures are recommended to minimize air intrusion into the system.

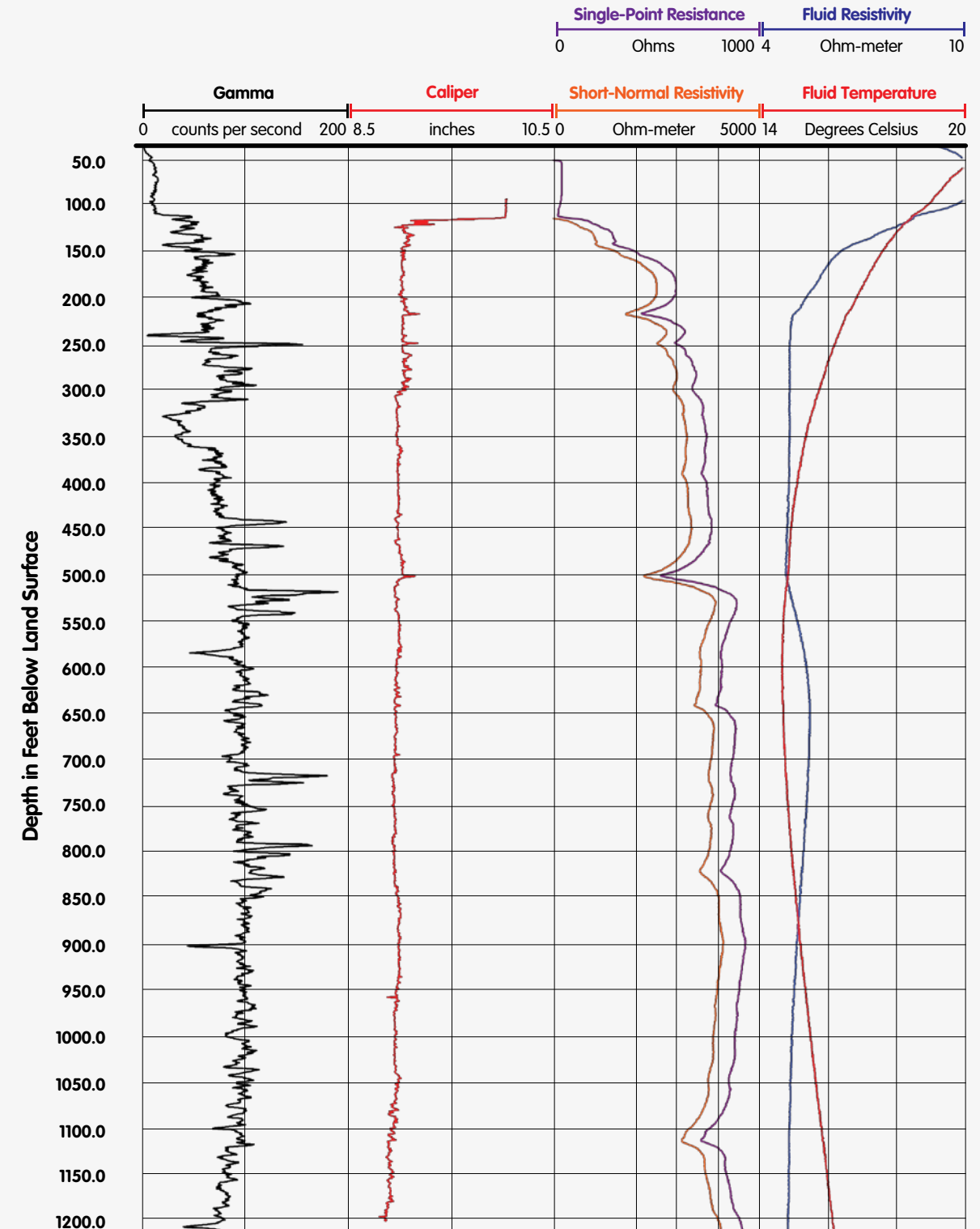
Ground water in the Inwood Marble can contain high suspended solids, which is detrimental to the operation of submersible pumps and heat exchangers of a **SCW**.

A6 Ground Water Temperatures

Ground water temperatures recorded by the [USGS](#) and recent geothermal installations in the city have ranged from 55°F to 65°F, varying by system type, location, depth to ground water, and season. There may be areas in Brooklyn and Queens where there is high ground water usage for cooling and corresponding ground water temperatures that are higher than elsewhere. Ground water temperature is critical to heat pump selection, operation, and ultimately performance. Therefore, no assumptions should be made, but actual temperatures should be determined through field measurements. The existence of permitted wells in proximity to a project site can be researched using the resources shown in Appendix C.

An example of a temperature profile in a standing column well recently drilled in lower Manhattan is presented on the following page. The fluid temperature profile on the right side of the graph varies by depth, and represents the ground water temperature of the bedrock measured in the well. It is also interesting to note that water temperature at this location decreased from land surface down to approximately 600 feet, then increased to the last data collection point at 1,200 feet. Note that the well was not circulating water during field measurements and actual operation may affect temperatures. Additional information on the use of temperature logs can be found in the research paper published by Stumm, S. and Chowdhury, S., 2003.

Ground Water Temperatures



Appendix B

Field-Testing

B

B **1** Introduction

Field testing is essential for commercial sized closed loop and open loop geothermal systems. The two primary objectives are to confirm the system's feasibility and to develop site specific data for proper system sizing and design. Testing is especially important in urban areas like New York City where building loads may be high and there is limited outdoor space to properly locate wells or loops. It can be beneficial for a standing column well system but may not be necessary or cost effective.

Testing should be conducted as early as possible in the project, optimally during the schematic design phase. Otherwise, delays and impacts to the project's budget can arise. **Table B.1** summarizes the recommended tests, objectives and potential use of the data.

Table B.1
Field Testing

GHP System Type	Required Conditions	Field Tests	Objectives	Comments
Closed Loop	For systems over 50 tons or approximately 25 loops	Drill/ install full-depth test loop, one test loop per each 25 loops planned.	Investigate drilling conditions. Determine depth to bedrock. Develop data to obtain better competitive bids.	Data may indicate adjustment needed to planned loop depths and numbers based on observed bedrock depth and conditions.
		Perform 48-hour thermal test.	Develop design data. Determine site-specific thermal conductivity/thermal diffusivity for sizing/designing the loop field.	Test loop optimally installed to same depth and specification anticipated for final system design for representativeness purposes.
Open Loop	All Open Loop systems	Drill/ install small diameter 2"–4" ground water sampling well.	Confirm feasibility. Determine depth to ground water. Develop design data and data for filings, e.g., Long Island Well permit, NYCDEP sewer discharge approval.	Data may indicate need to re-evaluate system suitability if poor ground water quality is encountered.
		Drill/ install typical 6" diameter test well and conduct pumping test.	Develop design data. Determine depth to ground water and site-specific aquifer properties for designing the wells. Determine sustainable flow rates and drawdowns for pump size and depth. Develop data to obtain better competitive bids.	
		Option: Use geotechnical wells, if available, for ground water sampling.	Same as above: Confirm feasibility. Determine depth to ground water. Develop design data and data for filings, e.g., Long Island Well permit, NYCDEP sewer discharge approval.	Not always possible due to shallower depths of geotechnical drilling. Direct driller to construct observation wells to ground water sampling well spec, e.g., minimum 2" diameter, filter pack, bentonite seal.
		Option: Use other wells such as existing environmental testing wells for ground water sampling	Same as above: Confirm feasibility. Determine depth to ground water. Develop design data and data for filings, e.g., Long Island Well permit, NYCDEP sewer discharge approval.	Inspect well to verify it's condition and suitability, e.g., intact surface seal, no debris in well, water level is as expected for site.

GHP System Type	Required Conditions	Field Tests	Objectives	Comments
Standing Column Wells	Systems with more than 8–10 planned wells	Drill test well to full depth.	Confirm feasibility and develop design data. Determine depth to bedrock and ground water. Investigate drilling/bedrock conditions. Determine bedrock yield for bleed. Determine thickness of upper weathered bedrock zone for casing length. Develop data for competitive bidding purposes.	Data may indicate: (1) Adjustment needed to planned well depths or numbers based on depth reached. (2) Need to re-evaluate system suitability and costs if overall poor bedrock conditions and/or thick upper weathered bedrock zone is encountered.
		Perform pumping/drawdown test	Determine bedrock ground water yield for bleed. Determine drawdown to select pump and return pipe depth.	Data may indicate: (1) Adjustment needed to well depths or numbers based on site bleed potential. (2) Need to re-evaluate system suitability if low well yield to bleed is encountered.
		Sample ground water.	Confirm feasibility, develop design data and data for NYCDEP sewer discharge filing.	Data may indicate: (1) Need for plate-frame heat exchanger between wells and heat pumps. (2) Need to re-evaluate system suitability if poor ground water quality is encountered.
		Option: Drill shallow test well (of <500 ft; NYSDEC permit is not required)	Confirm feasibility and develop design data. Determine depth to bedrock. Investigate drilling/ bedrock conditions. Determine thickness of upper weathered bedrock zone for casing length.	Same as above: Data may indicate: (1) Adjustment needed to planned well depths or numbers based on site bleed potential. (2) Need to re-evaluate system suitability if poor ground water quality, low well yield to bleed, overall poor bedrock/ ground water conditions, and/or thick upper weathered bedrock zone are encountered.

B 2 Closed Loop System

The most important data for proper sizing of a closed loop system are thermal conductivity and thermal diffusivity. Appropriate testing consists of installing a test loop and conducting a 48 hour thermal conductivity test. A standard loop is installed, optimally to the same depth and specification anticipated for final system design. The loop is then filled with water and connected to a thermal test setup consisting of a circulator pump, heating element and data recorder. Water is circulated for 48 hours through the loop as the heating element heats the water entering the loop to a constant temperature above ground temperature. This then simulates a load imposed on the ground. The return temperature is monitored and recorded.

Eventually the return temperature reaches an equilibrium value, and the average thermal conductivity and diffusivity of the geology is calculated by the instrument. The data are downloaded to the loop field sizing software to determine the total length of loops, depths, and spacing required to satisfy the building load profile.

A secondary objective of installing a test loop is to determine site specific geologic conditions for drill penetration rate. A test loop and geologic log should be prepared and included in the contract documents for use by bidders to most accurately bid the job.

B 3 Open Loop System

The primary objective of testing is to determine if ground water quality meets permitting requirements and will not promote excessive iron precipitation, scaling or biofouling. A ground water sample is collected from a small test well or existing well. The sample should be analyzed by a state certified laboratory and the results evaluated by an experienced hydrogeologist with respect to potential for scaling, biofouling, and corrosion of system components.

If there are no existing wells on the site, a test well is drilled to establish the type of geologic deposits, depth to ground water, aquifer thickness, and ground water quality. If the quality is acceptable, the next step is to convert a test well into a finished well and conduct an aquifer pumping test to determine its hydraulic properties. Hydraulic conductivity, transmissivity, and specific yield are used by the well designer to model the response of the aquifer during system operation, and to select well depths, screen length, and well spacing to meet the building's load and minimize well interference.

During test well drilling, split spoon samples should be collected similar to a conventional geotechnical drilling project. Unconsolidated samples obtained from the intended well screen zone are submitted for grain size analysis to properly select the slot size and filter pack. Borehole geophysical logging is advisable to confirm the lithology inferred from actual samples collected. A 48 to 72 hour aquifer pumping test is then conducted. The rate of water level drawdown is recorded for the pumping well and at least one other well. Drawdown data are then plotted and analyzed to calculate the hydraulic properties, design the wells and verify their spacing.

B 4 Standing Column Well System

A typical testing program involves drilling and installing a test well, sampling ground water, and performing a pumping test for at least 24 hours to determine the well yield. Ground water should be analyzed for the same constituents as an open loop system. Results for ground water quality, well yield, and depth to bedrock are used to verify the required depth of the surface casing, favorable bedrock conditions, water quality, and if the intended design bleed rate can be met. Even though the minimum yield for bleed may not be achieved in the test well, the **SCW** option does not have to be eliminated as other wells on the site may still produce the minimum required yield. However, the owner should be aware that additional wells may be necessary if yield requirements are not met.

On some projects, drilling a partial depth test well to only 500 feet has been considered rather than a typical 1,500 foot well. This would avoid the need to obtain a drilling permit from **NYSDEC** while still providing information on the bedrock conditions for shallow depths, which is where most water-bearing fractures occur. However, NYSDEC will not approve a permit for deepening a shallow test to serve as the complete well without initially approving the test well.

A **SCW** test well can provide data on shallow bedrock conditions for estimating the surface casing, ground water yield and estimating bleed potential for the system. However, SCW test wells are not routinely completed for the following reasons:

Installing a full depth SCW involves a lengthy permitting process through **NYSDEC** for a drilling permit and **NYCDEP** for sewer discharge approval.

SCW program is generally more involved and costly for a single well as compared to a single test loop or open loop test well.

Mobilization alone is an involved and potentially disruptive process to existing facility operations; in addition to associated costs to the project.

Test results may not necessarily be representative of conditions across a site because of bedrock variability.

Standing Column Well System

The most critical parameter for a SCW is the potential yield for bleed, which is used to design the system. Instead of a test SCW, the industry practice has been to allow for contingencies during construction to install more wells or deeper ones. To make up for lost capacity because of low well yield and bleed capacity. More linear footage of a well provides added thermal capacity through conduction.

Regardless of the high costs, a test SCW may be warranted if space for drilling is limited and all wells must have high capacity. A low yielding test well may indicate the need to reduce building loads, incorporate a hybrid system, or to abandon the particular **GRCO** and/or a **GHP** system altogether.

Appendix C

Supplemental Regulatory Requirements



C 1 Federal Filing - USEPA

As part of the **USEPA** filing under the **UIC** program, a well Plugging and Abandonment Plan must be submitted in the event that a well will be taken out of service in the future. Without proper abandonment, the well casing can act as a potential conduit for surficial contamination into deeper aquifers. Following well installation, a ground water sample must be analyzed for pH, chlorides, total dissolved solids, specific gravity and submitted to USEPA.

C 2 New York State Permits and Filings – NYSDEC

C.2.1 Division of Mineral Resources

The owner must report to the NYS Department of Mineral Resources **DMR** specific milestones and activities, including, but not limited to, start of drilling, date of casing cementing, date when drilling reaches total depth, and date of pump installation. Within 30 days after the completion of the well a Well Drilling and Completion Report **6** must be filed by the owner summarizing the drilling and completion details. An interim Well Drilling and Completion Report must be filed if there is a delay in completing the well for its intended use. An annual report is also required which describes the current status and use of the well.

C.2.2 Division of Water

Under **NYSDEC** Long Island Well Permit program for open loop wells in Brooklyn and Queens, project sites near areas considered by NYCDEC to be environmentally sensitive, such as regulated wetlands, may require an **environmental assessment form EAF 7** that outlines potential impacts and plans for mitigation. If the project comes under the jurisdiction of the **State Environmental Quality Review Act SEQR** or **City Environmental Quality Review Act CEQR**, environmental review under that program takes precedence over preparing an EAF.

6 See **Table D2** for more information.

7 For more information on EAF, see **Section 5.4.2**

C 3 NYC Permits and Filings

C.3.1 NYCDEP Water Tunnel Clearance

Specific **NYCDEP** requirements are as follows:

Geothermal well drilling is not allowed within 200 feet of the centerline of a water tunnel (No Drilling Zone).

Rider A covers drilling locations 200 feet to 300 feet from the centerline of a water tunnel; the angular deviation and directional survey requirements are as follows:

A survey is required every 50 feet of depth from land surface to a depth of 100 feet above the crown of a water tunnel.

A survey is required for every 10 feet of depth from a depth of 100 feet above the crown of a water tunnel to a depth of 50 feet below the invert.

Surveys are not required from a depth of 50 feet below the invert of the water tunnel.

Rider B covers drilling locations 300 feet to 500 feet away from the centerline of a water tunnel; the angular deviation and directional survey requirements are the same as Rider A, except that from a depth of 100 feet above the crown of the water tunnel to a depth of 50 feet below the invert of the water tunnel, a survey is required every 25 feet of depth.

For drilling locations over 500 feet from the centerline, NYCDEP approval and angular deviation surveys are not required. **8**

8 For more information on Water Tunnel Clearance, see **Section 5.4.4**

NYC Permits and Filings

C.3.2 NYCDEP Sewer Discharge Permit

If the estimated daily water discharge is less than 10,000 GPD, only approval from the Division of Pollution Control and Monitoring (DPCM) is required. This division reviews water quality of the proposed discharge water and determines if pre-treatment is necessary. DPCM requires a completed Wastewater Quality Control application, water quality data, and a scaled site plan showing the type and size of public sewer lines, existing and proposed sewer connections, temporary pumps and piping to be used, and the proposed points of discharge to the sewer system. All documents and drawings must be stamped by a New York State RA or PE.

If the estimated daily construction water discharge is greater than 10,000 GPD, then in addition to the DPCM approval, approval is also required from the Division of Connections and Permitting (DCP). This division reviews the proposed water quantity discharge to ensure that the local sewer mains and receiving city wastewater treatment plant can handle the discharge.

DPC's application requires an indemnification agreement, scaled site plan, number and capacity of pumps to be utilized, the quantity, maximum flow rate, average daily flow, and duration of the proposed discharge. In addition,

data on the city sewer main and the connection piping to the site must be provided, including pipe locations and diameters, invert elevations at the property line and at the point of connection to sewer main, total capacity of the connection and the percent capacity to be used for dewatering (must be less than 10%), distance from city sewer to the property line, and the slope of connection. Backup computations must be provided and all documents and drawings must be stamped by a New York State RA or PE.

As-Built Sewer records and connection records can be obtained through the borough sewer office. If connection records are not available, the Owner must arrange with NYCDEP to perform a flow test with the results provided to DPC.

However, in some cases NYCDEP may not allow direct connections to the sewers through catch basins or manholes in the city sidewalks or streets. Rather, connection must be via an on-site discharge point, e.g., roof drain or house trap. If a new temporary sewer connection is required for dewatering, a licensed plumber must submit a sewer connection permit application.

NYC Permits and Filings

C.3.3 NYCDOH Permit Type 33

Bacteriological testing is required, and recommended for volatile organic compounds (VOC). Recycled standing column well bleed water must be rendered bacteriologically safe. An initial disinfection of the well is required using guidelines of the American Water Works Association (AWWA). Specifically, a solution containing one quart of ordinary laundry bleach (approximately 5% available chlorine) and 10 gallons of water must be poured down the well shaft. The solution should remain in the well for at least 24 hours, followed by straight pumping of the well to waste for at least 3 hours.

Appendix D Regulatory Agencies: Contact Information, Requirements and Resources



Table D1

Resources For Identifying Permitted Ground Water Wells

Geothermal System	Resource	Comments
Standing Column Wells	NYSDEC, Division of Mineral Resources, http://www.dec.ny.gov/imsmaps/minerals/viewer.htm	Records are available for wells that are deeper than 500 feet; wells shallower than 500 feet do not require a NYSDEC/ DMR permit.
Open Loop Wells	NYSDEC, Division of Water, Region 1, Stony Brook, N.Y.	Records for existing well permits under the Long Island Well Permit program can be accessed through a Freedom of Information Law (FOIL) request. Permits are required for facilities with wells with a total pumping capacity of 45 gpm or greater.
Standing Column Wells and Open Loop Diffusion Wells	USEPA UIC Program office, New York, N.Y.	Wells are regulated as Class V injection wells under the federal Underground Injection Control (UIC) program. Records for such wells can be accessed through a FOIL request with USEPA.

Table D.2

Regulatory Requirements for GHP Systems

Agency Name	Applicable Forms and Submittals	Permit or Approval Required	Applicable GRCO Types	Approximate Duration (filing to approval)	Boroughs Affected	Summary of Requirements	Agency Contact Information
<p>USEPA Region 2</p>	<ul style="list-style-type: none"> Inventory of Injection Wells, Form 7520-16 Various application attachments, geologic maps and cross sections, operating data, construction details, etc. Plugging and Abandonment Plan Ground water testing data upon well installation. 	<p>USEPA authorizes "by rule" the use of geothermal wells as Class V injection wells under the UIC Program.</p>	<p>SCWs and open loop wells</p>	<p>1 month</p>	<p>All boroughs</p>	<p>Notification of installation and use of geothermal wells is required under USEPA's UIC Program. Documentation of site location, hydrogeologic conditions, intended system operation, and a Well Abandonment Plan must be submitted in the notification package. Ground water data must be provided upon well installation.</p>	<p>Water Compliance Branch, Groundwater Compliance Section Telephone: 212-637-3766</p> <p>http://water.epa.gov/type/groundwater/uic/reportingforms.cfm#operators</p>
<p>NYSDEC</p>	<ul style="list-style-type: none"> Organizational Report, Form 85-15-12 Application for permit to drill a well, Form 85-12-5 Environmental Assessment, Form 85-16-5 Financial Security Worksheet, Form 85-11-2 Well Drilling and Completion Report, Form 85-15-7 Certified site plan Casing and cementing plan Various other submissions during and following construction 	<p>A Mining Permit is required for drilling below a depth of 500 ft.</p>	<p>Generally for SCWs only</p>	<p>Minimum 6-8 weeks</p>	<p>All boroughs</p>	<p>Well locations and coordinates must be shown on a signed/sealed site plan. Must follow specific DMR casing installation/grouting procedures. Environmental assessment required. Financial assurance and application fees apply to non-governmental agencies, otherwise only application fee applies to governmental agencies.</p>	<p>Division of Mineral Resources Bureau of Oil & Gas Permitting and Management Telephone: 518-402-8056</p> <p>http://www.dec.ny.gov/energy/1772.html</p>
<p>NYSDEC</p>	<ul style="list-style-type: none"> Joint Application Form (NYSDEC, U.S. Army Corps of Engineers, NYS Department of State) Permission to Inspect Property Environmental Assessment Form Region 2 Long Island Well Dewatering System Detail Sheet Region 2 Long Island Well Permit Application Supplement 	<p>A Long Island Well permit is required for wells with permanent pumps rated at ≥45 gpm (total for site).</p>	<p>Open loop wells, and very limited areas for SCWs</p>	<p>Minimum 6-8 weeks</p>	<p>Brooklyn and Queens</p>	<p>Joint application for permit with the Army Corps of Engineers, a Short Environmental Assessment Form, and a Long Island Well Permit form. Description of environmental conditions, a site plan with well locations, detailed well system design, and intended flow rates are required to be provided.</p>	<p>Division of Water, Region 2 Telephone: 718-482-4947</p> <p>http://www.dec.ny.gov/docs/permits_ej_operations_pdf/jointapp.pdf</p>
<p>NYCDOT</p>	<ul style="list-style-type: none"> Petition Form For A New Revocable Consent, Form RC-1 Certified site plan 	<p>(1) Revocable Consent Agreement required to drill and install wells and piping beneath city sidewalks.</p>	<p>All types</p>	<p>6 months</p>	<p>All boroughs</p>	<p>Signed/sealed drawing with surveyed well locations and sections through sidewalks. An application fee and annual fee apply. Fees are nominal for Landmark buildings and districts. Permit process includes public notification and comment period.</p>	<p>Division of Franchises, Concessions & Consents Telephone: 212-839-6550</p> <p>http://nyc.gov/html/dot/downloads/pdf/petitionform.pdf</p>
<p>NYCDOT</p>	<ul style="list-style-type: none"> Permittee Registration Application Application for Roadway/Sidewalk Permit(s) Maintenance and Protection of Traffic Plan (MPT Plan) 	<p>(2) Street Opening Permit required for temporary closure of sidewalk or street during construction.</p>	<p>All types</p>	<p>1 month</p>	<p>All boroughs</p>	<p>Requirements vary depending on size and complexity of project and borough. Filing typically made by the General Contractor or an expediter. A Maintenance and Protection of Traffic Plan (MPT Plan) must be submitted with the application. Contractor must be registered with NYCDOT. All other permits must be in place before this permit can be issued, such as Revocable Consent, DOB permits, etc.</p>	<p>Bureau of Permit Management and Construction Control (Filing Office) Telephone: 212-839-9647 or 9648</p> <p>Office of Construction Mitigation and Coordination (Technical, MPT Plans) Telephone: 212-839-8968</p> <p>http://www.nyc.gov/html/dot/html/permits/franinfo.shtml</p>

Table D.2

Regulatory Requirements for GHP Systems

Agency Name	Applicable Forms and Submittals	Permit or Approval Required	Applicable GRCO Types	Approximate Duration (filing to approval)	Boroughs Affected	Summary of Requirements	Agency Contact Information
NYCDEP	<ul style="list-style-type: none"> Wastewater Quality Control Application, Form DEP WQ-D-001 Application for Permits for Temporary Discharge of Groundwater into City Sewer System 	A sewer discharge permit is required to dispose of ground water generated during drilling/ well installation to a city sewer.	SCWs and open loop wells	4-6 weeks	All boroughs	Requires chemical testing of water to be discharged and compliance with discharge limits, otherwise pre-treatment can be required. Requires sediment removal and a site plan showing the work area, location of sedimentation tank, and manhole discharge location. Beneficial to check if discharge can be covered under existing dewatering discharge permit.	Division of Pollution Control and Monitoring (water quality) Telephone: 718-595-4715 Division of Permitting and Connections (water quantity) Telephone: 718-595-5223 http://www.nyc.gov/html/dep/pdf/water-sewer/dewatering_application.pdf
	<ul style="list-style-type: none"> Letter describing project and well depths, use, and locations Map showing well locations relative to city streets 	Approval is required if drilling within 500 ft. of city water tunnels .	All types	1 month	All boroughs except Queens (no water tunnels)	Requires letter stating the depth and use of the wells, and a map showing well locations. NYCDEP will issue a letter stating if wells are located within 500 ft. from a city water tunnel or associated structure and, if drift monitoring and reporting are required.	Bureau of Water and Sewer Operations Telephone: 718-595-5205
NYCDOH	<ul style="list-style-type: none"> Application for Permit, Form 314C Well Water Questionnaire 	A Type 33 Permit is required to use well water for non-potable purposes.	SCWs (use of bleed water for other uses) and open loop supply wells	1 month	All boroughs	Bacteriological analysis is required, and recommended for volatile organic compounds (VOCs) is recommended. Recycled SCW bleed water must be disinfected to kill bacteria.	Bureau of Public Health Engineering Telephone: 212-676-1531 http://home2.nyc.gov/html/doh/html/pheng/php33.shtml
NYCT LIRR Metro North PANYNJ	<ul style="list-style-type: none"> Varies by agency 	Notification and approval are required if drilling within 200 feet of any transportation structure , including tunnels, substations, fan buildings, etc.	All types	6 months	All boroughs	Requires a site plan showing the proposed drilling locations in relation to transportation structures. Drawings should be reviewed at the respective agencies to verify the transportation structures' location. The owner and drilling firm may have to procure additional insurance coverage. Vibration monitoring may be required in tunnels in proximity to the site.	NYCT, Capital Program Management Telephone: 646-252-3673

Appendix E – Sample Specifications for Modular Water-to-Air and Water-to-Water Heat Pumps



E 1 Sample Specification for Modular Water-to-Air Heat Pumps

The Sample Specification provided here is not intended to stand alone or necessarily relate directly to other sections of this manual, and must be integrated with the specifications developed for a specific project type.

General

General Requirements

This Specification is coordinated with and complementary to the General Conditions and Supplementary General Conditions of the Work, wherever applicable to Mechanical Work and Electrical Work.

Special Requirements for Mechanical and Electrical Work shall apply.

Description of Work

The work includes the providing of all labor, materials, equipment, accessories, services and tests necessary to complete and make ready for operation by the Owner, all water source heat pump units as shown on the drawings and hereinafter specified.

Quality Assurance

Manufacturing firms regularly engaged in the manufacture of this material with characteristics and capacities required, whose products have been in satisfactory use in similar service for not less than 10 years.

Provide product produced by the manufacturers, which are listed in Section "Approved Manufacturer's List".

Provide equipment whose performance, under specified conditions, is certified by the manufacturer.

All heat pump units shall be fully run tested at normal water flow rates at the factory prior to shipping.

Submittals

Refer to Special Requirements for Mechanical and Electrical Work and submit shop drawings.

Coordination

Refer to Special Requirements for Mechanical and Electrical Work and submit shop drawings.

Guarantee

Refer to Special Requirements for Mechanical and Electrical Work.

Spare Parts

For vertical high rise type units provide two (2) spare slide-in heating/cooling chassis for each type.

Provide an initial filter for each heat pump unit for operation during construction. Replace filters in each unit with a new filter after owner acceptance of the system. Also provide sufficient spare filters to allow the owner to replace the filters in each unit one time.

All spare parts shall be delivered to the site after acceptance of the building by the owner. Spare parts shall not be stored on the site during construction. Spare parts shall be delivered to the location within the building designated by the owner. Spare parts shall arrive in corrugated boxes.

Sample Specification for Modular Water-to-Air Heat Pumps

Vertical High Rise Type Water-to-Air Heat Pumps

General

All units must carry ARI/ISO Certification (Per Standard Appendix C T3256) and UL listing via appropriate labeling. Units shall have capacities and characteristics as listed on the drawing schedule and as specified herein.

Cabinet/Riser Section

Cabinet Riser Section shall be shipped as one complete unit with factory installed risers and interconnecting piping, valves and unions, removable motor and blower assembly, internal wiring to controls, "quick connect" chassis plugs, chassis slide rails and condensate drain pan.

A Return Air/Access Panel shall be provided that is easily removed to facilitate normal maintenance and service access, as well as slide-in chassis fan motor and incoming power.

The Control Access Panel shall be easily removable to provide access to controls and connections for chassis, fan motor and incoming power.

Supply Air Discharge Grilles shall be adjustable single deflection type. Size shall be as scheduled. A baffle shall be installed behind each grille mounted at the unit to attenuate fan noise, provide uniform velocity through the grille while blocking sight through the grille.

Cabinet/Riser section of furred-in models shall be fabricated of 20 gauge galvanized steel. The cabinet interior shall be lined with 2" coated fiber glass acoustical and thermal insulation. Front panels and control access shall be steel with baked-on semi-gloss enamel or prime coated for painting in the field, as required by the Architect.

Each furred-in unit shall be furnished with a solid acoustical type return panel. The panel shall include a control access door and shall be lined with insulation as specified herein.

Units shall include extruded aluminum discharge grille(s) for field installation and factory mounted dry wall stop flanges to facilitate cabinet "Furr-in".

Blower Section

The Blower Section shall include a direct drive, overload protected, two speed, permanent-split capacitor **PSC** type motor, resilient mounted with rubber-in-shear isolators, plus a forward curved, Double Width Double Inlet **DWDI** centrifugal blower wheel. The complete blower section shall be easily removable for service. Provide a two speed fan switch for external mounting near the thermostat, for occupant fan speed control.

Slide-In Heating/Cooling Chassis

The chassis shall be shipped separately from the cabinet/riser section. Chassis installation shall be accomplished by simply sliding the chassis in place, coupling factory assembled water unions (or attaching factory supplied hoses) and electrical "quick connect" plugs and adding the front air intake panel.

Refrigerant Circuit

The chassis shall contain all refrigerant components in a properly charged, sealed, leak and performance tested system. Sealed refrigerant circuit shall be certified for 450 psig working pressure and 1500 psig burst pressure. All refrigerant components shall be interconnected with copper tubing. The refrigerant system protection shall include compressor thermal overload, 40 °F low water

Sample Specification for Modular Water-to-Air Heat Pumps

temperature safety cut-out and high and low refrigerant pressure safety cut-out.

Fully hermetic rotary compressor shall be internally spring mounted and externally isolated to minimize mechanical vibration and sound transmission. Additionally, the compressor shall be mounted within a separate steel enclosure that is completely lined with thermal and acoustic insulation as specified herein.

Air-to-Refrigerant Coil construction shall be aluminum fins mechanically bonded to staggered copper tubes, mounted above primary drain pan which is fabricated of galvanized steel and completely coated with fire retardant, moisture proof insulation.

Water-to-Refrigerant heat exchanger shall be copper-nickel construction.

Four Way, Solenoid Activated, Pilot Operated Reversing Valve shall be utilized to shift refrigerant path from cooling to heating.

Electrical

Incoming Power shall be routed through a factory installed conduit from top or side of the cabinet for connection within unit control panel. The units shall include a factory installed unfused disconnect switch mounted in the control panel.

Piping

All Supply, Return and Condensate Water Piping Risers shall be of type L copper with a 3" swaged section at the top to accept risers from unit above. Riser lengths shall be determined by the contractor. Riser diameter shall be as shown on the drawings. Risers shall be spaced at least 5" apart (center to center) to facilitate field connections.

Combination flow measuring, balancing & shutoff valve with memory stops shall be installed on the supply & return to

each unit by the manufacturer. Valves shall be of the same manufacturer as other balancing and flow valves being provided under this contract so that a common meter can be used to measure flow in all valves.

Unit Operating Controls

Unit controls shall allow the compressor to cycle during normal cooling and heating operation without activating the reversing valve on each compressor cycle. Reversing valve solenoid shall be energized on the heating mode.

Unit controls shall include high pressure refrigerant cutout and low temperature water cut-out which energize the compressor lock-out relay upon sensing hazardous operating condition and shall not allow compressor operation until the condition has been corrected and the lock-out circuit is manually reset at the unit control.

The heat pump manufacturer shall provide a 24 volt manual changeover wall thermostat with a HEAT-OFF-COOL system switch, an AUTO-ON fan selector switch, and a HIGH-LOW fan speed selector fan switch. The thermostat shall plug into the unit control wiring after the walls are finished through a polarized male-female plug.

Extra Quiet Acoustical Treatment

Each unit shall be provided with the following added acoustical treatment for a quieter unit.

Denser insulation (3 lbs./cu. ft.): 1" thick in the compressor compartment, on the return panel and in the fan section.

The sides of the unit shall be insulated externally in the field with 3 inches of 3lb./cu. ft. insulation. (See detail on drawing.)

Testing for standard units, without this ad Drain Pan Elevation

Sample Specification for Modular Water-to-Air Heat Pumps

Drain Pan Elevation

Drain pans shall be mounted so as to provide positive draining to the outdoors for 1st floor mounted units.

Drain Pan Overflow Switch

Provide a liquid sensor at the top of each drain pan which upon sensing water will shut down cooling operation

Console Water Source Heat Pump Units

General

Finish and install Water Source Heat Pumps, as indicated on the plans with capacities and characteristics as listed in the schedule and the specifications that follow standard range 60°F to 95°F/15°C to 35°C

All equipment listed in this section must be rated in accordance with American Refrigeration Institute **ARI** and must be listed with Underwriters Laboratories **UL** or Edison Testing Laboratories **ETL**. The units shall have ARI, UL or ETL labels.

The unit shall consist of a subbase/backwrap for floor mounting and attachment to the back wall or floor, a cabinet capable of attachment to the backwrap and a slide-out chassis for mounting on the subbase. The chassis shall include the refrigeration system, fan assembly and all controls. Unit shall be shipped as a complete unit including subbase, backwrap, cabinet front and chassis.

Basic Construction

The cabinet shall be constructed of 18 gauge steel with welded corner bracing. A removable front cabinet shall

allow easy service access to the chassis. The cabinet shall have a 30° or 22° sloped top with an aluminum rigid base type discharge grille or a fire retardant ABS polycarbonate.

An access door shall be provided to cover the control section. Access door shall be held closed by a keyed lock. The units shall be painted with color as selected by the architect. There shall be no additional charge for special colors. The panels shall be thermally and acoustically insulated.

Fan & Motor Assembly

The fan motors shall be thermally protected multi-speed permanently lubricated, **PSC** type with thermal overload protection. To facilitate field service all units shall have a slide out fan deck and quick electrical disconnect.

Refrigerant Circuit

Units shall have a sealed refrigerant circuit including a rotary hermetic compressor, a refrigerant metering device, a finned tube refrigerant to air heat exchanger, a reversing valve, a coaxial (tube in tube) refrigerant to water heat exchanger, and safety controls including a high pressure sensor, and a low water temperature (freezestat) sensor.

Rotary compressors shall have thermal overload protection and shall be located in an insulated compartment to minimize sound transmission. Units shall have the compressor mounted on isolators to reduce noise and vibration transmission.

Refrigerant to air heat exchanger shall utilize enhanced aluminum fins and copper tube construction rated to withstand 400 PSI refrigerant working pressure.

Sample Specification for Modular Water-to-Air Heat Pumps

Refrigerant to water heat exchanger shall be of copper inner water tube and steel refrigerant outer tube design rated to withstand 450 psi working refrigerant pressure.

Reversing valve shall be four way solenoid activated refrigerant valves which shall fail to heating operation. If the unit fails to cooling a low temperature, thermostat must be provided to prevent over cooling of the room.

Safety controls shall include a high refrigerant pressure sensor, and a low water temperature (freeze-stat). Activation of any safety device shall prevent compressor operation via a lockout relay. The lockout relay shall be reset at thermostat or at the supplied disconnect switch. Units which may be reset at the disconnect switch only shall not be acceptable. The chassis shall have a removable condensate drain pan for easy service and cleaning.

The unit shall be capable of starting at entering air of 40°F and entering water of 70°F with both air and water flow-rates at the **ARI** rating condition.

Electrical

A control box shall be located within the unit and shall contain controls for compressor, reversing valve and fan motor operation and a transformer. Unit shall be name-plated to accept time delay fuses or Heating, Air Conditioning & Refrigeration **HACR** circuit breaker for branch overcurrent protection of the power source.

Unit Controls

Unit controls shall be located in a box under the control door. The control box shall be able to swing down for easy access for service.

Unit shall have a solid state control system. The control system shall have the following features.

Anti short cycle time delay on compressor operation time delay shall be 5 minutes minimum.

Random start on power up mode or return from night setback.

Minimize reversing valve operation for extended life and quiet operation.

Night setback override.

Low voltage protection.

Single grounded wire to initiate night setback, demand load shed, or emergency shut down.

Unit shutdown if high or low pressure switches trip.

Unit shutdown if freezestat actuated.

Option to reset unit at thermostat or at disconnect.

Automatic intelligent reset.

Ability to defeat time delays for servicing.

Light emitting diodes **LED** to indicate high pressure, low pressure, low voltage, freeze protection, condensate overflow and control voltage present.

Control logic shall only move the reversing valve when cooling is called for the first time. The reversing valve shall be held in this position until the first call for heating. Only control schemes that provide this reduced reversing valve operation will be accepted.

The ability to select high or low fan speed at the control panel.

Sample Specification for Modular Water-to-Air Heat Pumps

The control system shall have a unit mounted automatic changeover thermostat, night setback and override operation with continuous occupied fan operation, unit mounted night heating thermostat, unit mounted two hour override button, cycle fan in unoccupied mode, stop-start switch and high fan-low fan tap switches.

Drain Pan over Flow Sensor

Provide a liquid sensor at the top of the drain pan which upon sensing water will shut down cooling operation.

Extra Quiet Construction

The unit shall have additional compressor insulation 1" thick, 3 lb./cu. ft. density insulation in the entire compressor compartment and as cabinet insulation.

Horizontal Ceiling Concealed and Vertical Heat Pumps

General

Furnish and install horizontal, ceiling concealed and vertical floor mounted water source heat pumps, as indicated on the plans with capacities and characteristics as listed in the schedule and the specifications that follow.

Units shall be rated in accordance with **ARI** and **UL** or **ETL** rated. The units shall have ARI and UL or ETL labels. All units shall be factory tested under normal operating conditions at nominal water flow rates. Units which are tested without water flow are not acceptable.

Basic Construction

Horizontal units shall have one of the following air flow arrangements, Right-Discharge/Left-Inlet, Left-Discharge/

Right-Inlet, Back-Discharge/Left-Inlet; or Back-Discharge/Right-Inlet as shown on the plans. If units with these arrangements are not used, the contractor is responsible for any extra costs incurred. If other arrangements make servicing difficult the contractor must provide access panels and clear routes to ease service. These changes in layout must be approved by the architect.

Units shall be fabricated from heavy gauge galvanized (GS90 or G-60) sheet metal. All interior surfaces shall be lined with 2" thick 12 lb./ft; acoustic type glass fiber insulation. All fiberglass shall be coated and have exposed edges sealed or tucked under flanges to prevent the introduction of glass fibers into the airstream. All insulation must meet NFPA 90A.

All units shall have a painted baked enameled or galvanized finish.

Units shall have a factory installed 2 inch thick filter bracket for side filter removal. Units shall have a 2 inch a thick throwaway type glass fiber filter. Filters shall be standard sizes.

Cabinets shall have separate holes and knockouts for entrance of line voltage and low voltage control wiring. Supply and return water connections shall be copper FPT fittings and shall be securely mounted to the cabinet allowing for connection to a flexible hose. Unit shall have galvanized steel painted and insulated drain pan with a drain connection exit ending through the unit casing.

Manufacturer shall provide a sound attenuation package that shall include the following as a minimum.

All units 15,000 Btu/h (4,395 watts) and up must have a compressor discharge muffler.

Compressor side panels and base pan must have closed cell insulation rated at 5 lb./cu. ft. density.

Sample Specification for Modular Water-to-Air Heat Pumps

All reciprocating compressors must have high density damping material applied to the compressor shell.

All units 15,000 Btu/h (4,395 watts) and up shall have the compressor mounted on springs.

Unit shall have an insulated panel separating the fan and compressor compartments.

Refrigerant Circuit

Units shall have a single sealed refrigerant circuit including a hermetic compressor, capillary expansion tube(s), finned tube heat exchanger, reversing valve, water-to refrigerant heat exchanger, access valves, and safety controls.

Compressor shall be hermetic type with external vibration mounts and thermal overload protection. The finned tube coil shall be constructed of aluminum fins bonded to copper tubes. The exchanger shall be rated for 400 psig on the water side and 450 psig on the refrigerant side.

Safety controls shall include a low suction temperature (freezestat) switch and a high refrigerant pressure switch to lock out compressor operation. Units for 4 tons and above shall have a low refrigerant pressure switch for loss of charge protection. A low pressure switch shall not be permitted to replace a low suction temperature switch for freeze protection. Units shall be capable of being reset only by interrupting the power supply to the unit. Unit shall not be able to be reset from the wall thermostat.

Electrical

A control box shall be located within the unit and shall contain controls for compressor, reversing valve and fan motor operation and shall have a 50 or 75 VA transformer, circuit breaker in the low voltage circuit, and a terminal

block for low voltage field wiring connections. Unit shall be nameplated to accept time delay fuses or **HACR** circuit breaker for branch overcurrent protection of the power source.

Unit control system shall provide heating or cooling as required by the setpoints of the wall thermostat. The unit control scheme shall provide for fan operation simultaneous with compressor operation (fan interlock) regardless of the thermostat type. The unit shall provide an output signal to an **LED** on the thermostat to indicate a "fault" condition from the activation of any one of the safety switches.

Fan and Motor Assembly

Units shall have a direct drive centrifugal fan. The fan housing shall have a removable orifice ring to facilitate fan motor and fan wheel removal. The fan housing shall protrude through the cabinet to facilitate field duct connections. The fan motor shall be a **PSC** type with integral mounting brackets isolated from the fan housing and thermal overload protection. Units above one ton shall have a terminal strip mounted on the fan motor to facilitate motor speed change. Units shall have a straight-through or right-angle discharge air arrangement and shall be able to be field converted from one to the other without the use of additional parts.

Control System

Unit shall have a microprocessor based control system. The unit control logic shall provide heating and cooling operation as required by the setpoints on the wall thermostat. The control system shall provide the following:
The use of programmable wall thermostats.

Sample Specification for Modular Water-to-Air Heat Pumps

Fan operation simultaneous with the compressor(fan interlock) regardless of thermostat logic.

Time delay compressor operation.

Delayed de-energization of the reversing valve for quiet reversing valve operation.

Compressor short cycle protection of a minimum of three minutes before restart is possible.

Night setback temperature setpoint input signal from the wall thermostat.

Override signal from wall thermostat to override unoccupied mode for 2 hours.

Brownout protection to suspend unit operation if the supply voltage drops below 80% of normal.

Condensate overflow protection to suspend cooling operation in an event of a full drain pan.

Suspended compressor operation upon activation of the refrigerant pressure switch(es).

Cooling operation activated for 60 seconds upon activation of the low suction temperature (freezestat) switch - defrost cycle.

Method of defeating compressor, reversing valve and fan time delays for fast service diagnostics.

Controls to allow water temperature to minimum 40°F.

Thermostats

Provide a programmable wall mounted thermostat for one stage heating, one stage cooling, night setup, night setback and day/night time clock operation from a built in time clock. Thermostat occupant override switch for night time operation.

Flexible Hoses

Provide two fire rated flexible hoses with **American Society for Testing and Materials (ASTM)** ratings of Flame Spread 25, Fuel Contribution 25 and Smoke Density 50 for connection to unit and field piping. Hose shall be covered with galvanized steel.

Valves

Provide one combination flow measuring balancing and shutoff valves with adjustable memory stop per unit.

Drain Pan Over Flow Sensor.

Provide a liquid sensor at the top of the drain pan which upon sensing water will shut down cooling operation.

Heat Pump Installation, Service, and Guarantee (All Units)

The heat pump unit manufacturer shall provide field coordination to insure that the Contractor's job site representative is instructed as to the manufacturer's recommended installation requirements. Copies of field reports shall be forwarded to the Contractor, Architect and Consulting Engineer following each job site coordination visit by the Manufacturer.

The manufacturer shall start-up all heat pump units. Start-up consists of inspecting installation of the heat pump units and operating the heat pump units under all modes of operation. The manufacturer shall instruct and demonstrate the proper operation of the heat pump units to the Owner's representative. The manufacturer shall complete a "Start-Up Report" which shall be signed by the Contractor's job

Sample Specification for Modular Water-to-Air Heat Pumps

site representative after satisfactory completion of the above startup responsibility. A copy of the "Start-Up Report" shall be forwarded to the Owner, Architect, Consulting Engineer and Contractor.

The manufacturer shall be responsible to perform all conditioner service (not Maintenance) for 24 months subsequent to acceptance of the units by the owner. The Contractor shall purchase equipment including the above start-up and service. The Contractor may not perform the start-up and service with his own personnel.

The entire heat pump unit shall be warranted to be free from defects in manufacturing and workmanship for 24 months from acceptance by the owner. The refrigeration circuit shall be warranted for an additional 36 months over and above the initial 24 month warranty. The refrigeration circuit consists of the motor compressor assembly, evaporator coil, condenser coil, automatic expansion valve, capillary tube assembly, and interconnecting tubing. Repairs during this 36 month period shall be made at the heat pump manufacturer's expense at a factory designated repair station.

Water Loop Heat Pump Controller

Provide a water loop controller to control the heat pump water loop temperature. The **Loop Water Controller (LWC)** shall be a stand-alone, pre-programmed, pretested, microprocessor-based controller providing control of the heat rejection, heat addition stages and the water circulating pumps for control of the water source heat pump system through solid-state output relays.

The controller shall have a keypad/display to view all status conditions, temperatures, setpoints and monitor/alarm

conditions. The display shall be two lines by sixteen columns in a supertwist LCD format.

The LWC shall be applied to control the heat pump water loop having a boiler and separated by a water-to-water heat exchanger in the closed loop cooling tower to the condenser water loop with a cooling tower.

The LWC shall control heating and cooling stages from the heat pump loop supply temperature and from the outdoor air temperature for reset of the heat addition setpoint. Other locations which shall be temperature monitored shall include: the heat pump loop return temperature, entering and leaving tower temperatures, entering and leaving boiler temperatures.

The LWC outputs to control heat rejection (cooling) stages, and heat addition (heating) stages. Each heating and cooling output shall have individual on and off (differential) setpoint adjustment capability. Modulating heating output signals shall be available to control heat addition through the boiler management system.

Safety alarms shall include visual and audible notification of a low water temperature, high water temperature, or no flow condition. Upon activation of any alarm, the LWC contacts shall send out an emergency shutdown signal. A remote alarm panel shall be provided for alarm notification at a remote location.

Provide software which allows the operator to monitor and control setpoints of the LWC through a personal computer by direct connecting or through a phone line.

Additional features shall include built-in test mode to simulate all control modes, heat cycle to start heat addition earlier for undersized boilers, precool cycle to start heat rejection earlier for undersized towers and keypad password protection.

Heat Pump Installation, Service, and Guarantee (All Units)

Execution

Inspection

Contractor shall examine location where this equipment is to be installed and determine space conditions and notify architect in writing of conditions detrimental to proper and timely completion of the work.

Do not proceed with the work until unsatisfactory conditions have been corrected.

Installation

Install equipment where shown, in accordance with manufacturer's written instructions, and with recognized industry practices, to ensure that equipment comply with requirements and serve intended purposes.

Coordinate with other work as necessary to interface installation of equipment with other components of systems.

Check alignment and, where necessary (and possible), realign shafts of motors and equipment within tolerances recommended by manufacturer.

Field Quality Control

Upon completion of installation of equipment, energized with normal power source, test equipment to demonstrate compliance with requirement. When possible, field correct malfunctioning units, then retest to demonstrate compliance. Replace units which cannot be satisfactorily corrected. Refer to Testing and Balancing Specification.

E 2 Sample Specification for Modular Water-to-Water Heat Pumps

General

Related Documents

This Specification is coordinated with and complementary to the General Conditions and Supplementary General Conditions of the Work, wherever applicable to Mechanical Work.

Special Requirements for Mechanical and Electrical Work shall apply.

Summary of Work in this Section

The Work includes providing all labor, materials, equipment, accessories, services and tests necessary to complete and make ready for operation by the Owner, modular chillers as hereinafter specified.

Quality Assurance

Provide equipment whose performance under specified conditions is certified by the manufacturer. The heat pumps shall use multiple refrigerant compressors each with an independent refrigerant circuit, each of which is no larger than 15 HP.

The heat pump manufacturer shall guarantee that the heat pumps supplied will meet the specified performance conditions when the heat pump is installed.

All modules shall be listed in accordance with **UL** and shall bear the **American Society of Mechanical Engineers ASME** UM stamp on all heat exchangers.

All modules shall ship completely wired and fully charged with refrigerant and oil, ready for installation. All modules shall be factory run tested per **ARI** at full load design conditions prior to shipment. A report of factory test shall be submitted to the engineer.

Assembly of modules, start-up and on-site training of owners staff shall be supervised by the locally authorized and factory trained service representative. The representative shall submit a letter stating that the heat pump modules have been properly assembled and installed.

The assembled heat pump systems shall be capable of being serviced and repaired in place without the need for removal of a module.

Key parts supply shall be available locally and be backed up by the factory parts supply. Submit name, address and telephone number of local supplier.

Manufacturing firms regularly engaged in manufacture of this material with characteristics and capacities required, whose products have been in satisfactory use in similar service for not less than 5 years.

Provide equipment whose performance under specified conditions is certified by the manufacturer.

Submittals

Refer to Special Requirements for Mechanical and Electrical Work and submit shop drawings.

Submit the following for approval prior to shipment:

A complete detailed set of construction and erection drawings for equipment including vibration isolators and bases indicating dimensions, materials of construction and methods of assembly.

Complete capacity and performance data for both heating and cooling including all items indicated in the equipment schedules.

Curves indicating capacity and efficiency versus leaving chilled and condenser water temperatures up to 20° above and for leaving hot water and source water temperature 20°F below those specified.

Sample Specifications for Modular Water-to-Water Heat Pumps

Equipment sound levels in each of the eight octave bands based on readings taken and reported in accordance with ASHRAE Standard 36-72, 1972 Measurement of Sound Power Radiated from Heating, Refrigerating and Air Conditioning Equipment.

Electrical wiring diagram.

Manufacturer shall review the modular control sequence specified and provide a written statement indicating that the sequence is acceptable or provide alternative recommendations. After the automatic temperature control shop drawings are complete, the manufacturer shall review the shop drawings as they apply to controlling the heat pump units and provide written approval of the shop drawings.

Operating Instructions and Training

After completion of all work and all tests and at such time as designated by the Architect, provide the necessary skilled personnel to operate the entire installation for a period of two (2) consecutive days eight (8) hours each for cooling (during the cooling season) and two (2) consecutive days eight (8) hours each for heating (during the heating season) and two additional days to be scheduled by the Owner.

During the operating period, fully instruct the Owner's representative in the complete operation, adjustment and maintenance of the entire installation.

All training shall be by factory authorized representatives, fully trained in the systems and the equipment operation and maintenance. The Contractor shall schedule the first day and the Owner shall schedule the other days. The additional days shall be scheduled within 1 year of the second two days of training.

Running Test of Heat Pump System

After the refrigeration equipment, piping and accessories have been tested and insulation applied, run the entire system for an 8-hour period in both cooling and heating mode. Run testing shall be done during the cooling season and again during the heating season. During this time, introduce upsets in all control devices to check their operation. After all devices have been tested and control system proved to function satisfactorily, reset the controls to the proper settings as directed by the Architect. The test of the overall performance shall be done in the presence of the heat pump manufacturer and the Owner's representatives. After the controls have been tested and proved satisfactory, the system shall be run under automatic control and the following data shall be logged & report:

Outside dry bulb and wet bulb temperatures.

Chilled (hot) water supply and return temperatures for the primary loop and each module.

Ampere nameplate rating of each compressor.

Actual ampere reading and voltage for each compressor.

Source/sink water supply and return temperatures.

Compressor refrigerant suction pressure and temperatures.

Compressor refrigerant discharge pressure and temperatures.

Suction and discharge pressure at each water pump.

Water pressure drop across condenser and chiller.

Water pressure drop across water strainers when the strainers are clean.

Sample Specifications for Modular Water-to-Water Heat Pumps

Guarantee

The manufacturer guarantees by his acceptance of the Contract that the equipment provided shall be free from any and all defects and that all apparatus will develop capacities and characteristics specified, and that if during a period of one year from date of shipment and as extended below any such defects in workmanship, material or performance appear, he shall immediately replace, repair, or otherwise correct the defect or deficiency without cost to the Owner within a reasonable time. The guarantee period must include one continuous cooling season from May 1st to October 1st, and one continuous heating season December 1st to March 30th.

This Article is general in nature and will not waive stipulations of other claims which specify guarantee periods in excess of one (1) year.

One year parts only warranty shall be furnished as standard. Four year extension of the compressor warranty shall be included.

Products

Description

Furnish and install modules as indicated on the drawings of water-to-water heat pumps.

General

Equipment shall be completely assembled, piped, internally wired, fully charged with HCFC-22 (CONSIDER ALTERNATE REFRIGERANT SUCH AS R410a) and test operated at the factory. A controls field interface terminal strip and all safety controls shall be furnished, installed and tested by the unit manufacturer. The unit shall be rated in accordance with ISO-ARI 13256-2.

The system's water inlet and outlet for the source and load-side connections shall be female NPT composed of copper. Service and caution labels shall be placed on the unit in their appropriate locations.

Cabinet

Unit casing shall be constructed of zinc coated, heavy gauge, and galvanized steel. Access to the refrigerant and controls shall be provided through the front, access panels.

All panels shall be insulated with 2" thick dual density bonded glass fiber. The insulation shall meet the erosion requirements of UL 181. It shall have a flame spread of less than 25 and a smoke developed classification of less than 50 per ASTM-84 and UL 723.

The unit shall be installed for proper access. Procedures for proper access inspection and cleaning of the unit shall be included in the maintenance manual.

Note that unit access, mounting and maintenance clearance is different for each manufacturer. The number of modules and layout will vary with manufacturer. The layout shown on the drawings is based on Compax. The Contractor is responsible for layout out alternate manufacturers in compliance with their requirements. Submit layout drawings for review and approval.

Compressors

Vibration isolation shall be provided through rubber mounting devices located underneath the compressor. Internal thermal overload protection shall be provided. Protection against excessive discharge pressure shall be provided by means of a high-pressure switch. A loss of charge shall be detected by a low pressure safety.

Sample Specifications for Modular Water-to-Water Heat Pumps

Refrigerant Tubing

The refrigerant tubing shall be of 99% pure copper. This system shall be free from contaminants and conditions such as drilling fragments, dirt and oil.

Refrigerant Circuits

The refrigerant circuit shall contain a thermal expansion valve. Service pressure ports shall be factory supplied on the high and low pressure sides for easy refrigerant pressure or temperature testing.

Reversing Valve

The reversing valve shall be a pilot operating, sliding piston type with a replaceable, encapsulated magnetic coil. The reversing valve shall be energized in the cooling cycle.

Water-to-Refrigerant Heat Exchangers

The water-to-refrigerant heat exchangers shall be of a high quality, coaxial coil for maximum heat transfer. The source-side heat exchanger shall be constructed of copper metal (COORDINATE MATERIAL WITH POSSIBLE GROUND WATER CONTAMINANT). The load-side heat exchanger shall be constructed of copper. Both heat exchangers shall be deeply fluted to enhance heat transfer and minimize fouling and scaling. The coil shall have a working pressure of 500 psig on the refrigerant side and 400 psig on the waterside. Provide an 800 micron mesh strainer at the inlet to the source side heat exchanger.

Electrical

Each unit control box shall contain the necessary devices to allow heating and cooling operation to occur from the BAS controller. These devices shall be as follows:

A 24 VAC energy limiting class II 100 VA transformer.

A 24 VAC compressor contactor for compressor control.

Field control connections shall be provided for ease of hookup to a terminal strip located in the unit's control box.

A lockout relay, which controls cycling of the compressor, shall be provided to protect the compressor during adverse operating conditions.

A high pressure switch shall be provided to protect the compressor against operation at refrigerant system pressure exceeding 395 psig.

A low pressure switch shall provide freeze protection to the compressor below 20°F suction.

Nameplate information shall be provided for the application of either time-delay fuses or **HACR** circuit breakers for branch circuit protection from the primary source of power.

Controls

The control package for each unit shall be provided with a 100 VA transformer with a circuit breaker. The controller shall include a lockout relay, anti-short cycle compressor protection, random start delay, brownout protection, low pressure time delay, compressor delay on start, RTD temperature sensors at the inlet and outlet of the source/sink and load sides of each module and terminal connections for:

Sample Specifications for Modular Water-to-Water Heat Pumps

A flow switch in the load and source/sink sides to shut down unit when there is insufficient flow.

A heat and a cool switch to control the operating mode of each unit from the **building management system (BMS)**.

Dry contact connections for alarm indication (to be connected to the BAS).

Dry contact connections for pump starting to be used to control automatic load side and source/sink side isolation valves for each module.

LED, light emitting diodes, display shall also be included for diagnostics of each unit via alphanumeric messages and providing menu selection of operating and override parameter and indication of alarms.

Ball Valves

Ball valves shall be furnished and field installed between the unit and the supply and return lines of the loop to stop water flow to the unit in a maintenance or service situation.

Automatic Isolation Valve

Provide an automatically controlled isolation valve in the load side and the sour/sink side which shall open when a module is activated.

Controls

The heat pump modules shall be controlled in a staged manner to satisfy the building load. Controls shall be as described in the specification. The individual module controllers and control panels shall provide for the sequence of operation as described in the specification.

Execution

Inspection

Contractor shall examine location where his equipment is to be installed, determine space conditions and notify Architect, in writing, of conditions detrimental to proper and timely completion of the work. Do not proceed with the work until unsatisfactory conditions have been corrected.

Installation

Install equipment where shown in accordance with manufacturer's written instructions and with recognized industry practices, to ensure that equipment complies with requirements and serves intended purposes.

A field qualified, factory trained, manufacturer's representative shall be present on site during all critical periods of the installation. Upon completion of the installation, the Contractor shall furnish a certificate from the heat pump manufacturer stating that the installation has been made in accordance with the manufacturer's installation requirements.

Coordinate with other work as necessary to interface installation of equipment with other components and systems.

Site Preparation

During the preparation of the site for installation of the modular heat pump, piping to be installed before the modules are set in place or before water side connections are made to the heat pump shall be coordinated with final location of the heat pump.

Sample Specifications for Modular Water-to-Water Heat Pumps

The Contractor shall provide strainers at the inlet of the water systems to each heat pump, the supply and return mains shall be temporarily connected with flexible hose and water circulated through the system in order to remove as much debris as possible prior to the installation of the heat pump.

Perform this clean up before installation of the heat pumps.

Field Quality Control

Upon completion of installation of equipment and after the motors have been energized with normal power source, test equipment to demonstrate compliance with requirements. When possible, field correct malfunctioning units, then retest to demonstrate compliance. Replace units which cannot be satisfactorily corrected. Refer to Testing and Balancing Specifications.

Appendix F – Sample of Pre-functional Checklist and Start-up Checklist



F 1 Sample of Pre-functional Checklist and Start-up Checklist

Pre-functional Checklist

Heat Pump Unit, tag: UNIT ID#

Components included:

- supply fans
- return & exhaust fans,
- coils,
- valves
- VFD
- dampers,
- compressors
- condensers

Submittal/Approvals

Submittal

The above equipment and system integral to them are complete and ready for functional testing. The checklist items are complete and have been checked off only by parties having direct knowledge of the event, as marked below, subject to an attached list of outstanding items yet to be completed. A Statement of Correction will be submitted upon completion of any outstanding areas. None of the outstanding items preclude safe and reliable functional tests being performed.

Pre-functional checklist items are being completed as part of post construction Commissioning work, preparatory to functional testing.

 This checklist does not take the place of the manufacturer's recommended checkout and startup procedures or report.

Items that do not apply are noted with the reasons on this form (**N/A** = not applicable, **BO** = by others).

If this form is not used for documenting, one of similar rigor shall be used.

Contractors assigned responsibility for section of the checklist shall be responsible to see that checklist items by their subcontractors are completed and checked off.

"Contr." column or abbreviations in brackets to the right of an item refer to the contractor responsible to verify completion of this item.

- | | |
|---------------------------------|------------------------------------|
| A/E Architect | GC General Contractor |
| ALL All Contractors | MC Mechanical Contractor |
| CxA Commissioning Agent | SC Sheet Metal Contractor |
| CC Controls Contractor | TAB Test/Balance Contractor |
| EC Electrical Contractor | OR Owner's Representative |

Approvals

 This filled-out checklist has been reviewed. Its completion is approved with the exceptions noted below.

Step 1 Submittals/Approvals

Mechanical Contractor MC	Date	Controls Contractor CC	Date
Electrical Contractor EC	Date	Sheet Metal Contractor SC	Date
TAB Contractor TAB	Date	General Contractor GC	Date
Commissioning Agent CxA	Date	Owner's Representative OR	Date

Notes:


Step 2 Requested Documentation Submitted

Check Equip Tag>	WSHP ID#	WSHP ID#	WSHP ID#
Manufacturer's cut sheets			
Performance data (fan curves, coil data, etc.)			
Installation and start-up manual and plan			
Sequences and control strategies			
Q&M manuals			

Documentation complete as per contract documents for given trade: ___Yes ___No

Step 3 Model Verification

Equip Tag>		WSHP ID#	WSHP ID#	WSHP ID#
Manufacturer	1	-----	-----	-----
	2	-----	-----	-----
	3	-----	-----	-----
Model	1	-----	-----	-----
	2	-----	-----	-----
	3	-----	-----	-----
Serial #	1	-----	-----	-----
	2	-----	-----	-----
	3	-----	-----	-----
Cooling Capacity	1	-----	-----	-----
	2	-----	-----	-----
	3	-----	-----	-----
Heating Capacity	1	-----	-----	-----
	2	-----	-----	-----
	3	-----	-----	-----
Fan Capacity	1	-----	-----	-----
	2	-----	-----	-----
	3	-----	-----	-----



 1=Specified

 2=as submitted

 3=as installed.

 Enter information and check if okay.

 Enter note number if deficient

The equipment installed matches the specifications for given trade: ___Yes ___No

Step 4a Installation Checks

Check Equip Tag	WSHP ID#	WSHP ID#	WSHP ID#
General Installation			
Casing in good condition: no dents, leaks, door gasket installed			
Heat transfer fluid has been added in the proper mix to prevent freezing in the closed-loop			
All the unit access panels are secure and in place			
Boot between duct and unit is tight and in good condition			
Vibration isolation is provided			
Unit is serviceable (mechanical clearances provided according to manufacturer requirement)			
Sound attenuation installed			
Low/high-side pressure temperature caps are secure and in place			
The thermostat is in the OFF position			

Enter information and check if okay
Enter note number if deficient

Step 4b Installation Checks

Check Equip Tag	WSHP ID#	WSHP ID#	WSHP ID#
Instrumentalization installed according to specification (zone thermostat installed in a good location and connected accordingly)			
Vibration isolation is provided			
Clean up of equipment completed per contract documents			
Filters installed and replacement type and efficiency permanently affixed to housing; construction filters removed			
Valved Piping and Coils			
Pipe fitting complete and pipes properly supported			
Pipes properly insulated			
Pipes properly labeled			
Strainer in place and clean			
Piping system properly flushed			

Enter information and check if okay
Enter note number if deficient

Step 4c Installation Checks

Check Equip Tag	WSHP ID#	WSHP ID#	WSHP ID#
No leaking apparent around fittings			
All coils are clean and find are in good condition			
All condensate drain pans clean and slope to drain per spec			
Condensate line trap installed per manufacturer			
Valves properly tagged			
Valves installed in proper direction			
P/T plugs and isolation valves installed per drawings			
Air and Water sensors properly located and secure			
Sensors calibrated (See calibration section below)			
Measures taken to deal with condensation, especially if fan will cycle			

Enter information and check if okay
Enter note number if deficient

Step 4d Installation Checks

Check Equip Tag	WSHP ID#	WSHP ID#	WSHP ID#
Ducts (preliminary check)			
Sound attenuators installed			
Duct joint sealant properly installed			
No apparent severe duct restrictions			
Pressure leakage tests completed			
Ducts cleaned as per specifications			
Balancing dampers installed as per drawings and TAB's site visit			
Outside air capability to space serviced by FCU installed			
Electric and Controls			
High voltage power supply is correct and in accordance with the nameplate rating			

Enter information and check if okay
Enter note number if deficient

Step 4e Installation Checks

Check Equip Tag	WSHP ID#	WSHP ID#	WSHP ID#
The field wiring and circuit protection is the correct size			
All electric connections right			
Proper grounding installed for unit			
Safeties in place and operable			
The low voltage control circuit wiring correct per the unit wiring diagram			
Final			
Safeties installed and safe operating ranges for this equipment provided to the commissioning agent			
Functional test procedures for this equipment reviewed and approved by installing contractor			

Enter information and check if okay
Enter note number if deficient

The checklist items of step 4 are successfully completed for given trade: ___Yes ___No

Step 5 Operational Checks

Check Equip Tag	WSHP ID#	WSHP ID#	WSHP ID#
Fan rotation verified			
Fan has no unusual noise or vibration			
Unit voltage and aps verified-each phase			
Air/water flow and air/water pressure drop verified			
Specified sequences of operation and operating schedules have been implemented with all variations documented			
Specified point-to-point checks have been completed and documentation record submitted for this system			
Startup report completed with this checklist attached			


These augment MFRS list. This is not the functional performance testing
Enter information and check if okay
Enter note number if deficient

The checklist items of part 5 are successfully completed for given trade: ___Yes ___No

Step 6 Sensor and Actuator Calibration

All field-installed temperature, relative humidity, CO, CO2 and pressure sensors and gages, and all actuators (dampers and valves) on this piece of equipment shall be calibrated using the methods and tolerances given in the Calibration and Leak-by Test Procedures document. All test instruments shall have had a certified calibration within the last 12 months: Y/N_____. Sensors installed in the unit at the factory with calibration certification provided need not be field calibrated.

Sensor or Actuator & Location	Location OK	1st Gage or BAS Value	Instr. Measured Value	Final Gage or BAS Value	Pass Y/N

 Gage reading = reading of the permanent gage on the equipment.
 BMS = building management system
 Instr. = testing instrument.
 Visual = actual observation.

The Contractor's own sensor check-out sheets may be used in lieu of the above, if the same recording fields are included and the referenced procedures are followed.

All sensors are calibrated within required tolerances: ___Yes ___No

Step 7 Start-up Checklist and Log

Functional Test (Start-Up)Attached below is a typical start-up and log form. The form records all components of a geothermal system and provides the engineer, designer and the Owner with increased confidence that the geothermal system was properly installed and integrated.

Initial Unit Start-up

Start up for basic controls is included below:

- ___ 1. Set the thermostat to the highest position.
- ___ 2. Set the thermostat system switch to COOL with the fan control to AUTO. The compressor should NOT run.
- ___ 3. Reduce the temperature control setting until the compressor, reversing valve, solenoid valve, and loop pump are energized.
- ___ 4. Adjust water flow utilizing pressure/temperature plugs and comparing to tables contained in specification sheet data from manufacturer. Water leaving the heat exchanger should be warmer than the entering water temperature (approximately 9°F - 12°F); blower operation should be smooth; compressor and blower amps should be within data plate ratings; the suction line should be cool with no frost observed in the refrigerant circuit.
- ___ 5. Check the cooling refrigerant pressures against values in operating pressures table provided by the manufacturer. Use the start-up checklist and log form to record readings.
- ___ 6. Turn the thermostat switch to the OFF position. Unit should stop running and reversing valve should de-energize.

- ___ 7. Leave unit off for approximately FIVE (5) minutes to allow pressure equalization.
- ___ 8. Turn the thermostat to the lowest setting.
- ___ 9. Set the thermostat system switch to the HEAT position.
- ___ 10. Adjust the temperature setting upward until the unit is energized. Warm air should blow from the register. A water temperature decrease of approximately 5°F-9°F leaving the heat exchanger should be noted. The blower and compressor operation should be smooth with no frost observed in the refrigeration circuit.
- ___ 11. Check the heating refrigerant pressures against values in operating pressures table provided by the manufacturer. Use the start-up checklist and log form to record readings.
- ___ 12. Set the thermostat to maintain the desired space temperature.
- ___ 13. Instruct the owner on system operation.

Step 8a Installing Contractor

Use this form to thoroughly check-out the system and units before and during start-up. (This form need not be returned to the factory unless requested during technical service support).

Mechanical Contractor:

Model Number:

Date:

Serial Number:

In order to minimise troubleshooting and costly system failures, complete the following checks and data entries before the system is put into full operation.

Step 8b Installing Contractor

Mode	Heat Source	Heat Load	Cool Source	Cool Load
Entering fluid temperature [°F]				
Leaving fluid temperature [°F]				
Return-air temperature DB/WB [°F]				
Supply-air temperature [°F]				
Temperature differential [°F]				
Water coil heat exchanger (Water pressure in) [PSIG]				
Water coil heat exchanger (Water pressure out) [PSIG]				
Pressure Differential [PSIG]				
Compressor				
Amps [A]				
Volts [V]				
Discharge line temperature (after 10 minutes) [°F]				



PSIG = pound-force per square inch gauge

Appendix G

Selected Glossary and References

G 1 Selected Glossary

A

Ambient

Surrounding environmental conditions

Aquifer

Fractured bedrock or unconsolidated deposits sufficiently saturated and permeable to yield economically significant quantities of water to wells.

B

Bedrock

The solid rock that underlies soil or other unconsolidated material.

Bleed

A flow of water from a standing column well that is not returned to the aquifer.

Borehole

A circular hole drilled into the ground.

British Thermal Unit

Also known as 'BTU'. The amount of heat needed to raise the temperature of one pound of water one degree Fahrenheit. BTUs are used to indicate the heating and cooling capacity of a system, including heat loss and gain.

Building Management System

A computer based system installed in a building to control and monitor energy use and other functional requirements.

C

Coefficient of Performance

A ratio of the heat extracted to the energy consumed in the process.

Cone of Depression

A depression in the water table or potentiometric surface that has the shape of an inverted cone, and develops around a well from which water is being withdrawn. It defines the area of influence of a well.

D

Drawdown

Distance between the static water level and the surface of the cone of depression.

F

Fault

A fracture or zone of fractures along which there has been displacement of the sides relative to one another parallel to the fracture.

Filter Pack

Sand or gravel that is smooth, uniform, clean, well-rounded and siliceous that is placed in the annulus of the well screen to prevent formation material from entering the screen.

Fracture

A crack, joint, fault or other break in rocks.

G

Geology

Study of the planet earth, its composition, structure, formation, and history.

Geothermal Energy

The earth's interior heat made available to man by extracting it from hot water or rocks.

Geothermal Heat Pump

Heating and cooling devices that take advantage of the relatively constant temperature of the earth's interior, using it as a source or sink for heat. When cooling, heat is extracted from the space and dissipated into the earth; when heating, heat is extracted from the earth and pumped into the space.

Gneiss

A course-grained regional metamorphic rock that shows compositional banding and parallel alignment of minerals.

Selected Glossary

Granite

A coarse-grained, intrusive igneous rock composed of quartz, orthoclase feldspar, plagioclase feldspar, and micas. Also, sometimes a metamorphic product.

Ground Coupling

An arrangement of piping and fluid handling equipment designed to exchange heat with the earth's interior.

Ground water

Water in the saturated zone that is under pressure equal to or greater than atmospheric pressure.

Grout

A fluid mixture of cement and water of a consistency that can be forced through a pipe and placed as required. In well construction, it is placed between the casing and the sides of the well bore to a predetermined height above the bottom of the well, securing the casing in place and excluding water and other fluids from the well bore.

H

Heat Exchanger

A device for transferring thermal energy from one fluid to another.

Heat Pump

A device used for heating and cooling which operates by moving heat from cooler to a warmer location and vice versa, by extracting heat from the air, water or earth.

Hydrogeology

The science that deals with subsurface waters and with the related geologic aspect of surface water.

I

Igneous Rocks

Formed by crystallization of lava or its subsurface parent material, magma, that may originate from the earth's mantle or as a result of metamorphism.

M

Marble

A metamorphic rock predominantly consisting of fine to coarse-grained recrystallized calcite and/or dolomite.

Metamorphic Rock

Sedimentary, igneous or older metamorphic rocks that have been changed by extreme temperatures and pressures resulting in new minerals and textures of the rock.

Moraine

A mound or ridge of accumulated, unsorted, unstratified glacial drift, predominantly till deposited chiefly by direct action of glacial ice.

O

Outwash Deposits

Silt and clay deposited from suspension on a flood plain by flood waters that cannot be contained within the stream channel.

Selected Glossary

P

Permeability

The property or capacity of a porous rock, sediment or soil for transmitting a fluid.

Pumping Test

A field test that is conducted to determine aquifer or well characteristics.

R

Recharge

In hydrology, the replenishment of ground water to the zone of saturation.

Runoff

The amount of rain directly leaving an area in surface drainage, as opposed to the amount that seeps out as ground water.

S

Schist

A metamorphic, crystalline rock characterized by strong foliation and parallelism of 50% of its minerals.

Sedimentary Rock

Rocks formed by consolidation of loose sediments into layers.

Soil

The layer of material at land surface that supports plant growth.

T

Thermal Conductivity

A measure of a rock's capacity for heat conduction

Till

Unstratified drift, deposited directly by a glacier without reworking by meltwater, and consisting of a mixture of clay, silt, sand, gravel, and boulders ranging wildly in size and shape. It is found in stony fields, drumlins, and moraines such as the Ronkonkoma and Harbor Hill moraines of Long Island.

W

Water Table

The surface of ground water which is at atmospheric pressure.

Well Logging

Assessing the geologic, engineering, and physical properties and characteristics of the subsurface with instruments lowered into a borehole.

Well Screen

A filtering device used to keep sediment from entering a water well.

Well Yield

The volume of water discharged from a well in gallons per minute.

Z

Zone of Saturation

The subsurface zone in which all the interstices are filled with water at greater than atmospheric pressure.

Selected Bibliography

Selected Bibliography

- Alley, W.M., Reilly, T.E., and Franke, O.L., 1999. Sustainability of Ground-Water Resources: U.S. Geological Survey Circular 1186, 86p.
- Askins, D., Posner, A., 2004. Hydrogeological Characterization for Siting Geothermal Wells in Fractured Bedrock at Bronx Zoological Park, Bronx, New York. Abstract presented at the 2004 U.S. EPA/NGWA Fractured Rock Conference.
- Baskerville, C. A., 1994. Bedrock and Engineering Geologic Maps of New York County and Parts of Kings and Queens Counties, New York and Parts of Bergen and Hudson Counties, New Jersey: U.S. Geological Survey Miscellaneous Investigations Series Map I-2306, 1:24,000, 2 plates.
- Baskerville, C. A., 1992. Bedrock and Engineering Maps of Bronx County and Parts of New York and Queens Counties, New York: U.S. Geological Survey Miscellaneous Investigation Series Map I-2003, 1:24,000, 2 plates.
- Boyce, P.K., Fitzsimmons, D., 2003. Open Loop Geothermal Well Systems on Long Island: Tenth Conference on Geology of Long Island and Metropolitan New York, Long Island Geologists, State University of New York, Stony Brook, Poster Presentation.
- Brown, C.J., Walter, D.A., 1999. Iron in the Aquifer System of Suffolk County, New York, 1990-98: U.S. Geological Survey Water Resources Investigations Report 99-4126, 10p.
- Buxton, H.T., Soren, J., Posner, A., and Shernoff, P.K., 1981. Reconnaissance of Ground Water Resources of Kings and Queens Counties, New York: U.S. Geological Survey Open-File report 81-1186, 59p.
- Buxton, H.T., Shernoff, P.K., 1999. Ground-Water Resources of Kings and Queens Counties, Long Island, New York: U.S. Geological Survey Water-Supply Paper 2498, 114p, 7 plates.
- Driscoll, F.G., 1986. *Groundwater and Wells*, 2nd Edition: Johnson Division, St. Paul, Minnesota, 1089p.
- Geothermal Heat Pump Consortium, 2007. Information for Evaluating Geoexchange Applications, prepared for New York State Energy Research and Development Authority (NYSERDA), 2004, 64p.
- Jenkins, J.T., 2007. *Guidelines for the Construction of Loop Wells for Vertical Closed Loop Ground Source Heat Pump Systems*, 3rd Edition: National Ground Water Association Press.
- Kimmel, G.E., 1971. Water-Level Surfaces in Aquifers of Western Long Island, New York in 1959 and 1970: U.S. Geological Survey Research 1971, 5p.
- McClymonds, N.E., Frank, O.L., 1972. Water Transmitting Properties of Aquifers on Long Island, New York: U.S. Geological Survey Professional Paper 627-E, 24p, 3 plates.
- McQuay International, 2007. *Application Guide AG 31-008, Geothermal Heat Pump Design Manual*: Mcquay International, Staunton, Virginia.
- Misut, P., Terracciano, S., 2009. Analysis of Aquifer Thermal and Water-Quality Effects from Regional Development of Geothermal Energy in New York State: U.S. Geological Survey Idea Proposal I09D, 8p.
- Monti Jr., J., Chu, A., 1997. Water-Table Altitude in Kings and Queens Counties, New York in 1997, 2p. <http://ny.water.usgs.gov/pubs/fs/fs13497/fs134-97.pdf>.
- Monti Jr., J., and Busciolano, R., 2006. Water-Table and Potentiometric Altitudes in Upper Glacial, Magothy, and Lloyd Aquifers Beneath Long Island, New York, March-April 2006: U.S. Geological Survey Scientific Investigations Map 3066, 4 sheets, 1:125,000. <http://ny.ims.er.usgs.gov/LImaps06/>, <http://pubs.usgs.gov/sim/3066/>, <http://ny.water.usgs.gov/projects/gisunit/LongIsland-SIM3066.html>.
- New York City Department of Design and Construction, August 2002. *Geothermal Heat Pump Manual*, 176p. www.nyc.gov/html/ddc/downloads/pdf/geotherm.pdf.
- Orio, C.D., Johnson, Rees, S.J., Chiasson, A., Deng, Z., Spittler, J.D., 2005. A Survey of Standing Column Well Installations in North America: ASHRAE Transactions III (2) 2005: 109-121.
- Perlmutter, N.M. Arnow, T., 1953. Ground Water in Bronx, New York and Richmond Counties with Summary Data on Kings and Queens Counties, New York City, New York: U.S. Geological Survey Bulletin GW-32, 86p., 5 plates.
- Schuberth, J.C., 1968. *The Geology of New York City and Environs*: The Natural History Press, 304p.
- Soren, J., 1978. Subsurface Geology and Paleogeography of Queens County, Long Island, New York: U.S. Geological Survey Water Resources Investigations 77-34, Open File Report, 17p.
- Soren, J., 1988. Geologic and Geohydrologic Reconnaissance of Staten Island, New York: U.S. Geological Survey Water Resources Investigations Report 87-4048, 22p., 5 plates.
- Soren, J., 1971. Ground-Water and Geohydrologic Conditions in Queens County, Long Island, New York: U.S. Geological Survey Water Supply Paper 2001-A, 39p., 2 plates.
- Stumm, F., Chu, A., Joeston, P.K., Lane Jr., J.W., 2007. Geohydrologic Assessment of Fractured Crystalline Bedrock on the Southern Part of Manhattan, New York through the Use of Advanced Borehole Geophysical Methods: J. Geophysics Eng. 4 (2007), p245-252.
- Stumm, F., Chowdhury, S., 2003. Delineation of Ground Water Flow in Fractured Rock in the Southwestern Part of Manhattan, New York Through Use of Advanced Borehole Geophysical Methods: J. Ground Water Monitoring & Remediation 23, No. 3, p42-49.
- Stumm, F., Chu, A., Lange, A.D., Paillet, F.L., Williams, J.H., and Lane Jr., J.W., 2001. Use of Advanced Borehole Geophysical Techniques to Delineate Fractured-Rock Ground-Water Flow and Fractures Along Water Tunnel Facilities in Northern Queens County, New York: U.S. Geological Survey Water Resources Investigations 00-4276, 12p.
- Walter, D.A., 1997. Geochemistry and Microbiology of Iron-Related Well-Screen Encrustation and Aquifer Biofouling in Suffolk County, Long Island, New York: U.S. Geological Survey Water-Resources Investigations Report 97-4032, 37p.

Acknowledgements

Executive Acknowledgements

City of New York

Honorable Michael R. Bloomberg

Mayor, City of New York

NYC Department of Design and Construction

David J. Burney, FAIA, Commissioner

David Resnick, AIA, Deputy Commissioner,

Public Buildings Division

Eric Boorstyn, AIA LEED AP,

Associate Commissioner,

Architecture & Engineering /

Technical Services

Updated and Edited by

NYC Department of Design and Construction –

Office of Sustainable Design

Thomas Paino, RA, Director,

Office of Sustainable Design

Alex Posner, PG

Wendy Wan, RA LEED AP CEM

Contributors

Kallen & Lemelson, Consulting Engineers, LLP

P.W. Grosser Consulting, Inc.

CRC Commissioning Engineers, PLLC

Book Design

Pentagram

A. Edward Opara, Partner

Ken Deegan, Designer

Carrie Kawamura, Design Assistant

Peer Reviewers

NYC Department of Design and Construction

Dennis Askins, PG

Brett Miller, PE CEM

Sal Zuccaro, PE CEM



Copyright © 2012-2013 by the New York City Department
of Design and Construction

Published by the New York City Department
of Design and Construction
Office of Sustainable Design
30-30 Thompson Avenue
Long Island City, New York 11101
718.391.1000

All rights reserved. No part of this publication may be
reproduced, stored in a retrieval system, or transmitted,
in any form or by any means, electronic, mechanical,
photocopying, recording, or otherwise, without the prior
permission of the New York City Department of Design
and Construction.

Design by Pentagram